



## Excavació Arqueològica d'Urgència a Mas Duran

Mora, Rafa ; Martín, Araceli ; Bordas, Anna ; Díaz, Jaume ; Burch, Montse ; Parcerisas, Quin ; Parpal, Albert



### **Avis legal**

Aquesta obra està subjecta a una llicència Reconeixement-NoComercial-SenseObresDerivades 2.5 de Creative Commons. Se'n permet la reproducció, distribució i comunicació pública sempre que se'n citi el titular dels drets i no se'n faci un ús comercial. No es pot alterar, modificar o generar una obra derivada a partir d'aquesta obra. La llicència completa es pot consultar a <http://creativecommons.org/licenses/by-nc-sa/2.5/es/legalcode.ca>.



MEMORIA  
MAS DURAN  
SANT QUIRZE DEL VALLÈS

VOLUM I

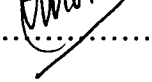
**COORDINADORS** .....  ..... **Rafael MORA**  
**Araceli MARTIN**

**DIRECTORS** .....  ..... **Anna BORDAS**  
**Jaume DIAZ**  
**Montse BUCH**

**AUTORS** ..... **Anna BORDAS**  
**Jaume DIAZ**  
**Montse BUCH**  
**Quim PARCERISAS**  
**Albert PARPAL**

*DEPARTAMENT D' HISTORIA de les SOCIETATS  
PRE-CAPITALISTES i ANTROPOLOGIA SOCIAL*

UNIVERSITAT AUTÒNOMA de BARCELONA

MEMÒRIA D'EXCAVACIÓ DELS TREBALLS DUTS A TERME  
ENTRE EL  
15 D'ABRIL AL 15 DE DESEMBRE DE 1991

BELLATERRA, FEBRER 1992

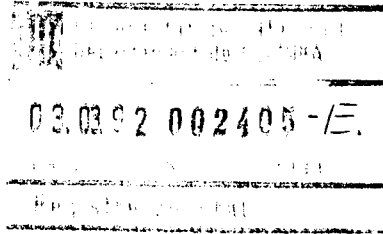

**MEMORIA  
MAS DURAN  
SANT QUIRZE DEL VALLÈS**

**VOLUM I**

**COL.LABORADORS..... Vicente LOPEZ  
Jordi CASADEVALL  
Xavier CARLÚS  
Jesus BERMUDEZ  
Meritxell SURINYAC  
Albert MONTULL  
Juan F° GIBAJA  
Joaquin VILLAFRUELA  
Josep DURAN  
Angel PEREZ  
Arcadi VILA**

***DEPARTAMENT D' HISTORIA de les SOCIETATS  
PRE-CAPITALISTES i ANTROPOLOGIA SOCIAL***

**UNIVERSITAT AUTÒNOMA de BARCELONA**

**MEMÒRIA D'EXCAVACIÓ DELS TREBALLS DUTS A TERME  
ENTRE EL  
15 D'ABRIL AL 15 DE DESEMBRE DE 1991**

**BELLATERRA, FEBRER 1992**



## INDEX

VOLUM I

I.- MARC GEOLOGIC DE LA BOBILA MADURELL .....	1
II.- SITUACIO GENERAL DE LA CAMPANYA MAS DURAN 91 .....	4
III.- METODOLOGIA .....	8
III.1.- METODOLOGIA DE CAMP .....	8
III.2.- TRACTAMENT DELS MATERIALS ARQUEOLOGICS AL LABORATORI .....	10
IV.- ESTRUCTURA D'HABITACIO .....	12
IV.1.- SEQÜENCIA ESTRATRIGRAFICA .....	16
IV.2.- NIVELL ARQUEOLOGIC H-2 .....	19
IV.3.- NIVELL ARQUEOLOGIC H-3 .....	28
V.- ESTRUCTURES D'EMMAGATZEMATGE .....	40
V.1.- CARRER 7 .....	40
V.2.- CARRER 10 .....	48
V.3.- CARRER 11 .....	56
V.4.- ILLA I .....	60
V.5.- ILLA M .....	68
VI.- ENTERRAMENTS .....	76
VI.1.- CARRER 7 .....	76
VI.1.1.- 7-7 .....	76
VI.2.- CARRER 11 .....	81
VI.2.1.- 11-2 .....	81
VI.2.2.- 11-3 .....	86
VI.2.3.- 11.4 .....	90
VI.3.- ILLA I .....	94
VI.3.1.- I-5 .....	94





## VOLUM I

<b>VI.4.- ILLA M</b> .....	97
<b>VI.4.1.- M-5</b> .....	97
<b>VI.4.2.- M-6</b> .....	103
<b>VI.4.3.- M-7</b> .....	106
<b>VI.4.4.- M-8</b> .....	111
<b>VI.4.5.- M-9</b> .....	115
<b>VI.4.6.- M-10</b> .....	119
<b>VI.4.7.- M-11</b> .....	122
<b>VI.4.8.- M-12</b> .....	126
<b>VI.4.9.- M-14</b> .....	129
<b>VI.4.10.- M-15</b> .....	132
<b>VI.4.11.- M-16</b> .....	136
<b>VII.- CARRER 8</b> .....	139
<b>VIII.- CARRER 9</b> .....	140
<b>IX.- LLAR 7.1</b> .....	141
<b>X.- R-9</b> .....	144
<b>XI.- MOSTRES RECOLLIDES</b> .....	145
<b>XI.1.- MICROMORFOLOGIA I MOSTRES DE TERRA</b> .....	145
<b>XI.2.- PALEOCARPOLOGIA</b> .....	148
<b>XI.2.1.- MOSTREIG</b> .....	148
<b>XI.2.2.- METODOLOGIA</b> .....	149
<b>XI.2.3.- PRIMERS RESULTATS</b> .....	150
<b>XI.3.- CARBONS</b> .....	152
<b>XI.4.- MALACOLOGIA</b> .....	156



## **INDEX**

**VOLUM II**

**ANNEX I.- LLIBRE D'ESTILL**

**ANNEX II.- SECCIONS DE L'ESTRUCTURA D'HABITACIO C-11**

**ANNEX IIIa.- INVENTARI DE L'ESTRUCTURA D'HABITACIO C-11**

**ANNEX IIIb.- INVENTARI DELS ENTERRAMENTS I DE LES ESTRUCTURES  
DE EMMAGATZEMATGE**

## I.- MARC GEOLOGIC DE LA BOBILA MADURELL

El jaciment arqueològic de la Bòbila Madurell se situa dins del terme municipal de St. Quirze del Vallès (comarca del Vallès Occidental) i, geològicament, s'inscriu en la conca geològica Vallès-Penedès.

La comarca del Vallès (Occidental i Oriental) s'enmarca dins la Depressió Pre-litoral catalana, i està compresa entre el Llobregat i la riera de la Tordera. Té una devallada molt lenta des dels 350 m al NE fins els 50 m a la seva part sudoccidental. Aproximadament, el Vallès coincideix amb la conca del Besós, sense la capçalera, que correspon a la comarca d'Osona, ni el curs baix del riu (Barcelonès). Els marges de la comarca estan delimitats, per una banda, per un ampli sector de la Serralada Pre-litoral (amb fragments annexats de la Depressió Central, a més dels conglomerats montserratins de Sant Llorenç del Munt) i, per altra, per un estret sector de la Serralada Litoral.

La depressió del Vallès-Penedès és una de les fosses tectòniques reconegudes en el marge oest de l'actual conca nordbaleàrica-provençal. Les fractures més importants que delimiten la depressió (d'orientació ENE-WSW) i les que travessen perpendicularment (Capellades-Vallcarca, Llobregat, etc...) es van originar i van actuar com falles de direcció i inverses durant l'etapa compressiva d'edat paleògena que va afectar als Catalànides. Les fractures d'orientació longitudinal respecte els Catalànides, varen ser reactivades com falles normals durant una important etapa distensiva neògena que ha determinat les actuals característiques morfoestructurals del sistema català. Les falles de direcció transversal, poden haver condicionat la definició de diferents dominis dintre de la fossa (Vallès Oriental i Occidental, Alt i Baix Penedès).

Degut a la seva morfologia de conca, és una zona especialment apta per a la retenció i conservació dels diferents aports sedimentaris que s'hagin pogut produir en el temps geològic.

El paquet de sediments quaternaris on s'assenta el jaciment de la Bòbila Madurell cobreix les fàcies conglomeràtiques i argiloses del Miocè superior. Aquesta unitat està formada fonamentalment per argiles groguenques que inclouen nòdols calcaris intercalats amb petites lleties de sorra i, a vegades, veritables nius de conglomerats.

El quaternari de la zona està format per argiles de color vermell intens amb nivells de conglomerats i crostes carbonatades. A la part més alta del paratge afloren, però, materials neògens, argiles grises i franges de conglomerats i sorres amb nivells de nòdols carbonatats no consolidats.

Aquestes argiles quaternàries, com és característic de tots els dipòsits sedimentaris, tendeixen a l'horitzontalitat. Per tant seran més potents a les zones deprimides (Pla de Terrassa, valls dels rius Ripoll i Sec, riera de Sant Cugat, zona de la Bòbila Madurell) i més primes a les zones enlairades (Serra dels Galliners, Serrat de Can Feu).

Geomorfològicament, el sector de la Depressió del Vallès anomenat Vallès occidental correspon a les conques del riu Ripoll i de la riera de les Arenes. Pertany a la Catalunya baixa (alçades inferiors als 400 m) de clima mediterrani subhumit (pluviositat anual al voltant dels 600 mm., temperatures mitjanes anuals que oscil·len entre 14 i 15 graus, nombre de dies relativament secs compresos entre 40 i 75).

**BIBLIOGRAFIA CONSULTADA:**

- AGUSTI, J. et alli (1985): "Sinopsis estratigràfica del Neógeno de la fosa del Vallés-Penedés." **Paleontologia i Evolució** n°1. Institut de Paleontologia Miquel Crusafont. Sabadell.
- AGUSTI, J. et alli (1990): "Neogen of Penedès area (Pre-litoral Catalan Depression, NE Spain)", a "Iberian Neogene Bassins". **Paleontologia i Evolució** n°2. Institut de Paleontologia Miquel Crusafont. Sabadell
- CANALS, T; FRANCES, J. (1985): "Breve síntesis geomorfológica del Vallés Occidental: los casos particulares de Bellaterra y Sant Cugat". **Estudios de la Antigüedad** n°2. UAB.
- CANALS, A.; MERCADAL, O.; RIBE, G. (1988): "El complex arqueològic BOBILA MADURELL-SERRAT DE CAN FEU. Història de la investigació (1921-1987)". **Arraona** n° 2. Sabadell.
- ROSSELL, J. et alli. (1973): "Sedimentologia del Mioceno del Vallés Occidental (prov. de Barcelona)". **Acta Geològica Hispànica** volum VIII. Granada.
- SOLE SABARIS, LI. (1961): **Oscilaciones del Mediterraneo español durante el Cuaternario**. C.S.I.C. Barcelona.
- VV.AA. (1980): **Geografia física dels Països Catalans**. Ed. Ketres. Barcelona.
- VV.AA. (1988): "Campanya d'excavacions arqueològiques 1987-88 al jaciment de la BOBILA MADURELL-CAN FEU (Sant Quirze del Vallès, Vallès Occidental)". **Arraona** n°3. Sabadell.

## II.- SITUACIO GENERAL DE LA CAMPANYA MAS DURAN 91

Els treballs d'excavació de la campanya 91 s'han centrat a l'àrea coneguda com Sector B de la Bòbila Madurell. Tota l'àrea queda limitada al Nord per l'avinguda Arrahona que uneix els nuclis urbans de Sabadell i Sant Quirze del Vallès, al Sur per la carretera comarcal 1413 a l'alçada de l'estació de ferrocarrils de Sant Quirze del Vallès, a l'Est per l'Autopista A-18 i a l'Oest pel nucli urbà de Sant Quirze del Vallès (Fig. 1)

La zona arqueològica havia estat delimitada pels treballs de prospecció fets pel Servei d'Arqueologia de Barcelona sota la direcció d'Araceli Martín. Abasta una àrea total d'uns 71.000 m<sup>2</sup>. La instal·lació de la Bòbila i els treballs d'extracció d'argiles van comportar la destrucció d'una superfície d'uns 17.000 m<sup>2</sup> i la divisió de la zona arqueològica en dues parts: el nucli principal situat al Nord de l'edifici de la Bòbila amb una àrea de 46.000 m<sup>2</sup>, i un triangle situat al Sud de l'edifici que ocupa una superfície de 8.000 m<sup>2</sup>. aproximadament.

Dels 46.000 m<sup>2</sup> del nucli central es treballa sobre una àrea d'uns 26.000 m<sup>2</sup> (zona que serà edificada) restant sense ésser excavada una franja de terreny paral·lela a l'autopista, que actualment és el talús artificial que separa la zona urbanitzable.







*Memòria MAS DURAN 1991*

**Fig. 1. - Visió General del Sector B de la Bòbila Madurell.**



L'àrea excavada l'any 1991 inclou les següents nomenclatures:

CARRER	ILLA
7	G
8	H
9	I
10	J
11	K
	M

Tot el treball arqueològic s'ha estructurat en base a aquests espais. Fins el moment que s'inclou en aquesta memòria s'han excavat les següents estructures arqueològiques (Fig. 2).

	LLAR	E.E.	SEPULTURA	E.H.
CARRER 7	1	5	1	-
CARRER 8	-	1	-	-
CARRER 9	-	-	-	-
CARRER 10	-	5	-	-
CARRER 11	-	2	3	1
ILLA I	-	5	1	-
ILLA M	-	6	11	-

0 100 m 200 m

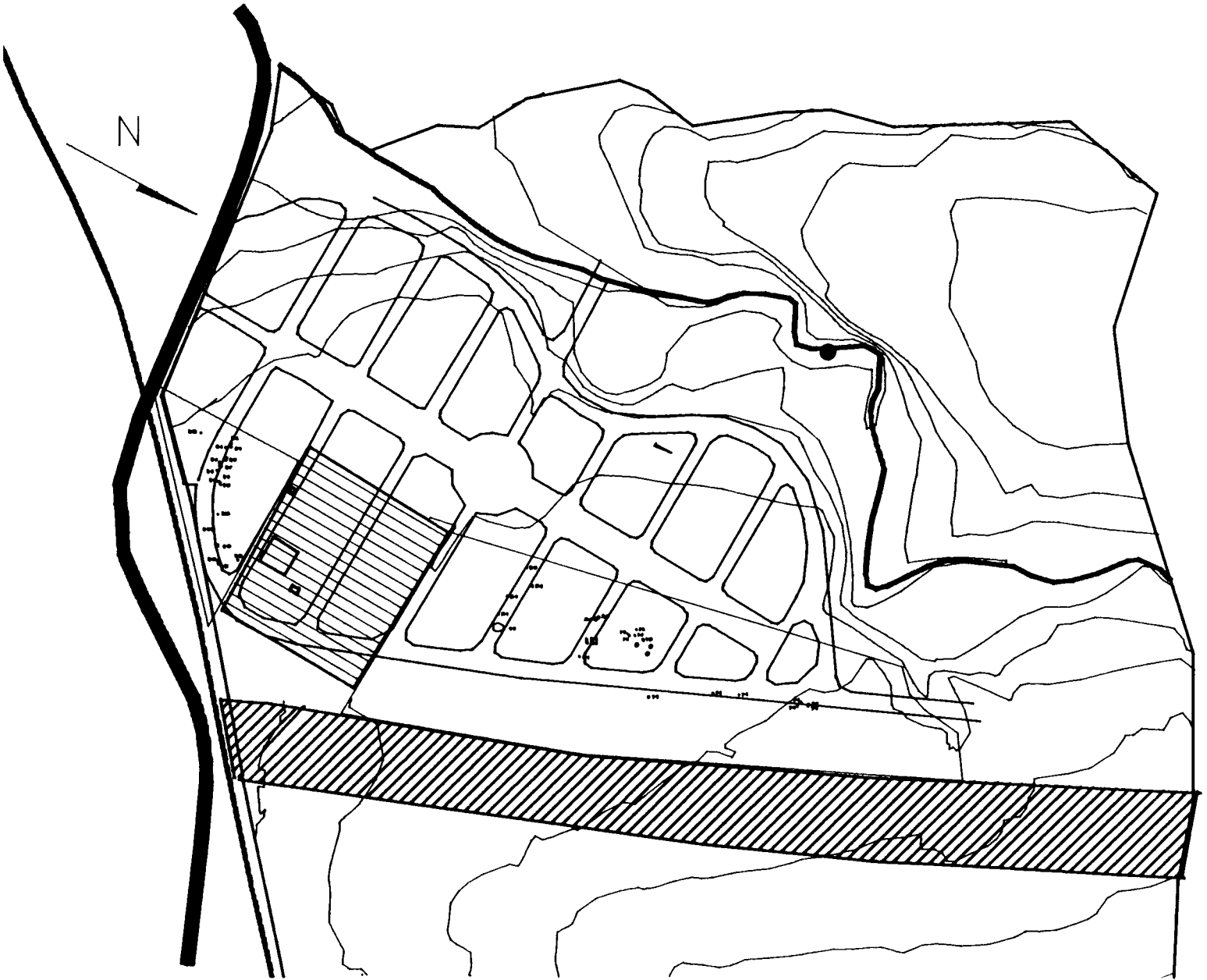

Fig. 2.- Localització de les estructures excavades a la campanya Mas Duran 1991.

### **III.- METODOLOGIA**

#### **III.1.- METODOLOGIA DE CAMP**

Una vegada determinada la zona arqueològica el pas a seguir fou el rebaixament controlat per un arqueòleg de la coberta vegetal amb la màquina excavadora. L'espessor de la coberta vegetal no és uniforme en tot el terreny sinó que oscil·la entre 30 i 60 cms. per damunt del subsòl. La prioritització d'àrees a treballar en el terreny és sotmesa al procés d'urbanització que pateix la zona. Així, en un inici es començà per les zones projectades com a carrers per després seguir amb les illes.

A l'hora d'aplicar una metodologia concreta sobre el camp vam tenir en compte les característiques de cada una de les estructures arqueològiques. D'aquesta manera tenim:

- Per un cantó vam utilitzar el sistema de coordenades cartesianes quan ens trobàvem davant d'un sòl d'habitació o d'estructures suposadament excavades al terra però de límits sedimentològics poc clars. En el primer cas, ens permetia conèixer la distribució espacial dels objectes i individualitzar les diferents unitats arqueològiques. En el segon cas, situant tridimensionalment tot el registre fòssil, podem reconstruir la forma original de les estructures.

- D'altra banda, per a les estructures d'emmagatzematge, excavades al subsòl i de límits clars, la metodologia emprada era diferent. Es procedia a la divisió de l'estructura en dos parts seguint l'eix N/S segons l'orientació de les coordenades cartesianes, començant a rebaixar sempre que fos possible el sector Est per tal de documentar la secció interna de l'estructura. Aquest eix N/S era situat topogràficament. El material fou recollit per talles de 10 cms. de les quals, i diferenciant per sectors, foren separades mostres de terra d'uns 10 Kg. aproximadament. Les del sector Est van ser tractades pel sistema de flotació a fi i efecte de recuperar les possibles restes paleocarpològiques. Les mostres del sector Oest foren garbellades amb aigua i amb garbells de diferents mides per obtenir macrorestes vegetals i fer anàlisis de C13, guardant 2 Kg. per d'altres anàlisis (pol·línics, microfaunístics...) La resta de la terra va ser garbellada en el mateix jaciment.
  
- En el cas dels enterraments, mentre no es documentés com a tal, es seguí el mateix procediment que a les estructures d'emmagatzematge, però quan es constatava que la fossa era sepulcral es procedia a excavar tota la superfície sistemàticament, coordinant i dibuixant tot el material a partir de l'eix geogràfic N/S. Igualment es guardava una mostra de la terra en contacte amb l'inhumat per a anàlisis paleocarpològiques i pol·líniques.
  
- Un cas excepcional a tractar és el de les llars. Per la seva complexitat funcional es va creure convenient dividir-les en quarts, seguint els eixos N/S i E/W, excavant-los oposadament per tal de poder documentar totes les seccions amb la seva estratigrafia, la qual ens pot indicar, per exemple, diferents reutilitzacions. (Veure Annex I).

### III.2.- TRACTAMENT DELS MATERIALS ARQUEOLÒGICS AL LABORATORI.

Una vegada els materials arqueològics han estat recollits a l'excavació són traslladats al laboratori. Bàsicament, les feines que s'hi realitzen són cinc: rentat, siglat, verificat i emmagatzematge de cadascuna de les peces. Posteriorment es procedeix al tractament informàtic de les dades obtingudes.

- 1) **Rentat.** Netegem les peces mitjançant la immersió en aigua a excepció d'aquelles que no es poden rentar pel tipus d'estudi concret que s'ha de portar a terme (estudis de greixos, funcionalitat...),
  
- 2) **Siglat.** Les ceràmiques i les peces macrolítiques són siglades directament sobre la seva superfície mitjançant l'aplicació d'un quadrat de pintura de maqueta de color blanc on, un cop seca, s'hi escriuran les dades d'identificació de la peça amb un rotulador indeleble aplicant-hi, posteriorment, una gota de vernís per a la seva fixació. Les ceràmiques són siglades sempre per la seva cara interna exceptuant les que hi tenen decoració. En els casos en que no es pot fer servir aquest sistema, el siglat es fa sobre una etiqueta de paper vegetal. És el cas de les restes lítiques, els ossos humans, les restes macrolítiques que presenten concreció per tota la seva superfície, i per tant, no permeten ser siglades directament. Es procedeix d'igual manera amb carbons, tovots i exemplars de malacologia així com totes les peces d'ornamentació (denes...).

En el siglat de cada peça s'hi especifica, per ordre: a) signatura de l'excavació i any de la campanya (BM91), b) número del quadre o de l'estructura i c) número correlatiu de cadascuna de les peces.

BM 91 264,555 1		BM 91 M.8 1
-----------------------	--	-------------------

- 3) El **verificat** consisteix en corregir les possibles equivocacions que es puguin produir en el moment de documentar els materials en l'excavació. Aquestes correccions es realitzen, quan s'escau, sobre els mateixos fulls de coordenats. En el cas de les estructures d'emmagatzematge també s'inventaria el material seguint les pautes marcades en el llibre d'estil
- 4) **Emmagatzematge.** Una vegada les peces han estat verificades es guarden en caixes atenent dos criteris: el número de quadre (o d'estructura) i el tipus de material. En el cas de les estructures també s'ha de tenir en consideració la talla i el sector.
- 5) **Tractament de la informació.** Les dades recollides a l'excavació són enregistrades sistemàticament sobre suport magnètic mitjançant l'aplicació combinada de software especialitzat en el tractament de bases de dades i de disseny assistit per microordinador, sempre en les versions creades per a sistema I.B.M i compatibles.

Per aquest propòsit ha estat emprada la programació en DBASE, tant en les seves versions comercials (DBASE III Plus, DBASE IV i MXFOXPLUS produïdes per Ashton-Tate Inc.) com en adaptacions pròpies atesa la condició singular de molts dels problemes que presenta la investigació arqueològica.

Igualment, s'ha procedit a enregistrar magnèticament bona part de la informació gràfica que genera l'excavació, fent-nos servir d'AUTOCAD (Computer Aided Design, produït per Autodesk), i SURFER (Golden Software Inc.), programes que poden actuar de manera compatible, la qual cosa permet una millor definició i resolució de la problemàtica proposada. (Veure Annex I).

#### IV.- ESTRUCTURA D'HABITACIÓ

Un cop rebaixat el carrer 11 (Fig. 3) es van detectar tres agrupacions de materials que vam associar a tres possibles estructures d'emmagatzematge. El primer objectiu plantejat era el d'individualitzar les estructures que a nivell sedimentològic no presentaven límits clars. Per això, es va netejar la superfície i, posteriorment, es va excavar en extensió. Malgrat tot, els límits sedimentològics no es van trobar i el material s'anava extenent en superfície funcionant com unitat arqueològica.

Davant d'això ens vam plantejar que es tractava d'una sola estructura d'unes dimensions considerables, 50 m<sup>2</sup> aproximadament, que cap el Sud (en relació a la quadrícula) es trobava delimitada sedimentològicament.

A l'exterior teníem el subsòl geològic, és a dir, argiles grogues amb nòduls de carbonats de dimensions variables, mentre a l'interior el material es localitzava dins d'unes argiles fosques amb pocs o cap nòdul de carbonat. El següent pas va ser resseguir el canvi sedimentològic i a la vegada realitzar un sondeig rebaixant de forma sistemàtica una zona fronterera al canvi de sediment (l'eix de la y=554 i de la y=555). Així vam anar comprovant per una banda que els límits eren correctes i com s'anaven extenent tancant-se cap l'Est i l'Oest; per l'altre que el material arqueològic es distribuïa per tota l'extensió formant una unitat arqueològica. Al mateix temps es va realitzar un sondeig de 1 m<sup>2</sup> i 90 cms. de fondària a l'exterior de la mateixa donant un resultat negatiu.

ESTRUCTURA  
D'HABITACIO

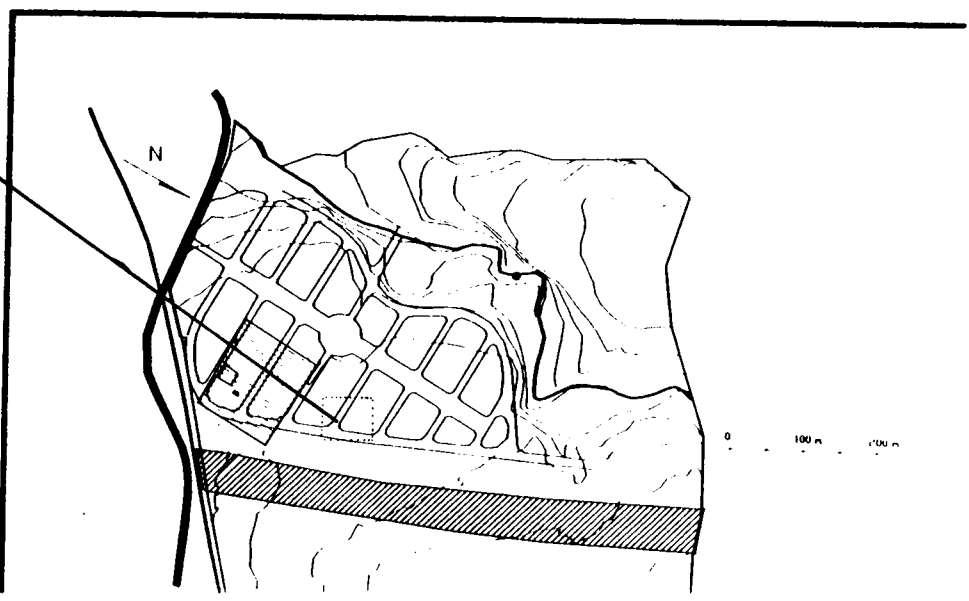

0 100 m 200 m

Fig. 3.- Localització de l'estructura d'habitació dins del carrer 11.



Pel que fa al sondeig de l'eix y=554 i y=555 vam poder determinar varis aspectes que ens van ajudar a comprovar que ens trobavem davant d'una estructura d'habitació:

- 1.- Es van individualitzar dues unitats arqueològiques amb una dinàmica assimilable a nivell arqueològic. Aquestes no només eren determinades per la distribució del material, sobretot ceràmiques que en secció mostraven dos moments diferenciats (Fig. 4), sinó també per un canvi en els sediments.

El primer nivell (que seria l'últim cronològicament) l'anomenarem H-2 es trobava dins d'un sediment d'argiles fosques (estrat A) amb molta matèria orgànica i cargols, mentre que el segon nivell, l'H-3, el primer cronològicament, es localitzava dins d'unes argiles vermelloses amb alguns nòduls de carbonats, destacant l'absència total de cargols (estrat B) (Fig. 5).

- 2.- es van documentar estructures internes de clara utilitat habitacional com són: dues llars i dues estructures d'emmagatzematge.
- 3.- en fondària el canvi sedimentològic que marcava els límits superiors de l'estructura eren constants i de fàcil resseguiment.

Un cop comprovat que es tractava d'una estructura d'habitació vam continuar obrint en extensió per determinar la seves dimensions i els seus límits al Nord i a continuació es va excavar individualitzant les unitats arqueològiques a partir del canvi sedimentològic del reompliment.

Fig. 4.- Secció transversal del sondeig Y=554 i Y=555, del registre ceràmic.

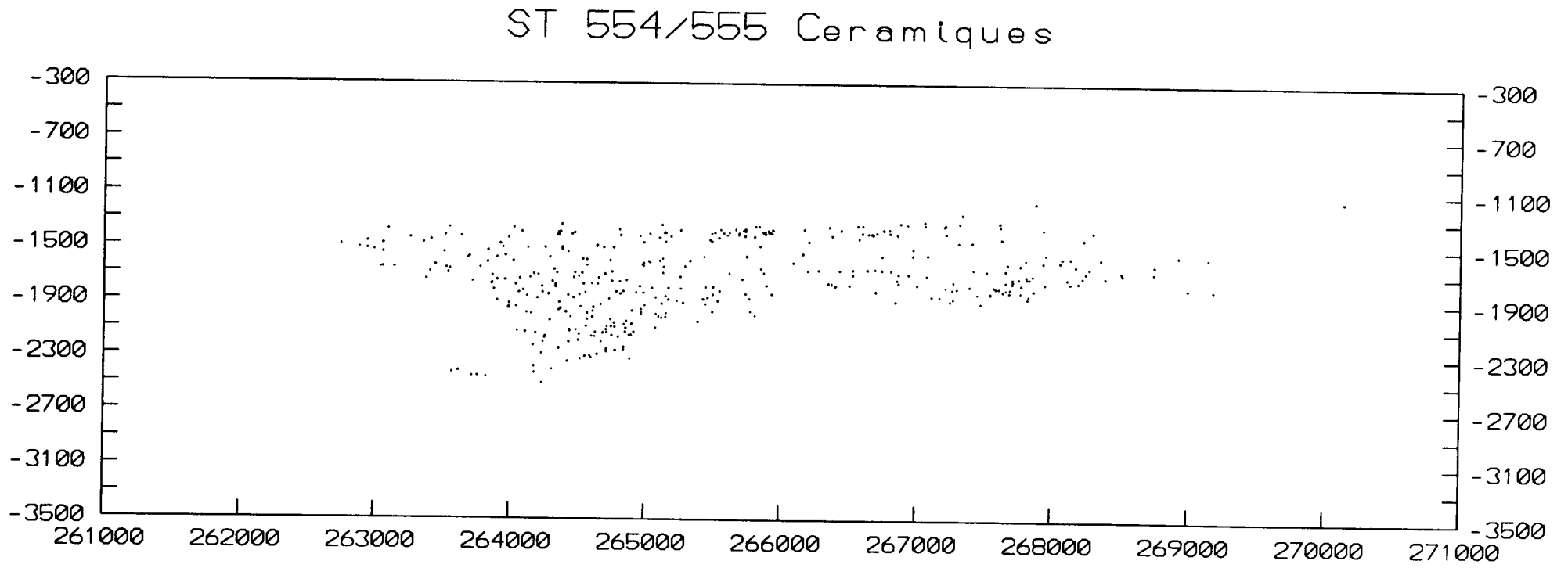

#### **IV.1.- SEQÜÈNCIA ESTRATRIGRÀFICA**

Un cop finalitzat el sondeig y= 554/555, es va procedir a l'aixecament i dibuix de la seqüència estatigràfica de la secció E-W del quadre y=555 (Fig.5). L'observació de la mateixa va permetre distingir diferents estrats geològics dels que alguns d'ells contenen el nivells arqueològics, així com part de la seva dinàmica.

##### **A.- Argiles marrons**

Argiles amb molta matèria orgànica adquirint una coloració fosca. Les restes antracològiques i malacològiques són abundants.

El límit superior està definit per la coberta vegetal.

La seva potència no és homogènia. Al llarg de tota l'extensió varia de 40 cms. a l'Est fins a 60 cms. a l'W. Conté la unitat arqueològica H-2.

##### **B.- Argiles taronges**

Argiles taronges amb poca presència de nòduls de carbonats. S'hi constaten restes antracològiques molt esporàdiques i no es documenten restes malacològiques. A la base apareixen plaques de carbonats.

Conté la unitat arqueològica H-3, i la seva potència és variable al llarg de tota la secció. Presenten major espessor cap a l'Est.

### **C.- Argiles grogues**

Correspón al substrat geològic de l'àrea. Està compost per argiles groguenques i nòduls calcàris. Era perfectament identificable, conformant els límits externs i de la base de l'estructura.

### **D.- Argiles vermelles**

Són les argiles quaternàries i contenen nivells de conglomerats i crostes de carbonats. S'alternen amb les argiles grogues, trobant-se al mateix nivell o superposades.

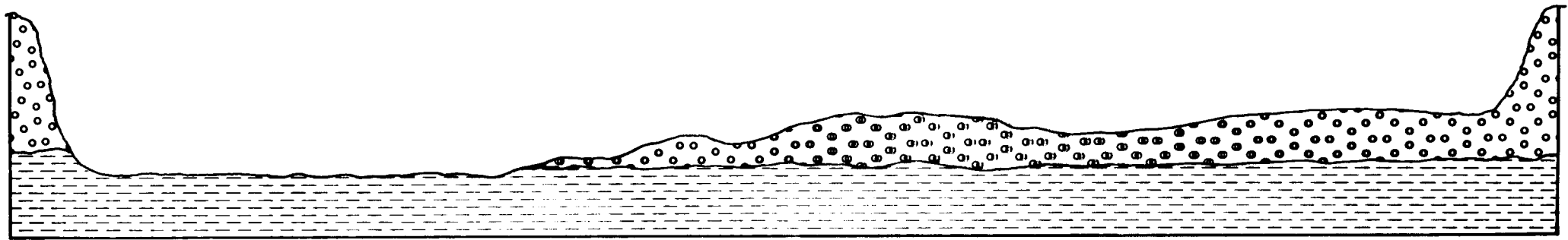

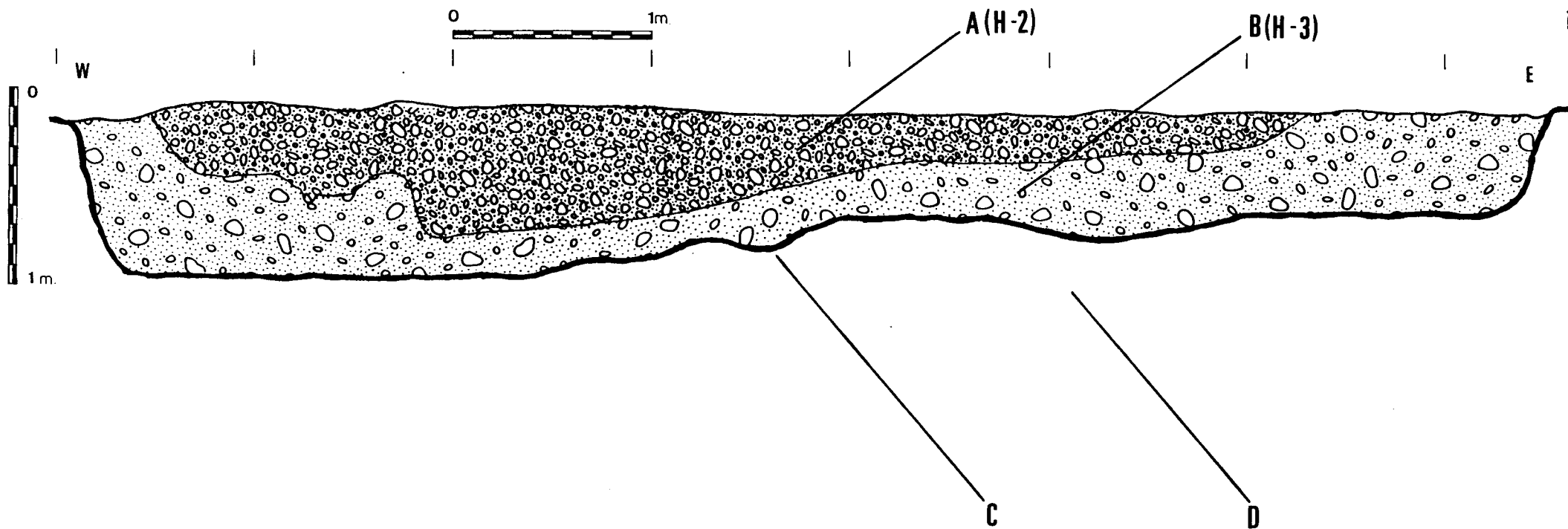

Fig. 5. - Sección estratigráfica de l'œil V = 555

## IV.2.- NIVELL ARQUEOLÒGIC H-2

Aquesta U.A., com ja hem dit, és la més recent i es troba dins d'un sediment d'argiles fosques amb molta matèria orgànica (sobretot carbons i cargols) que excavat en extensió ens marca un pendent direcció sud variant l'espessor del paquet en funció d'aquest pendent ( més prim cap el Nord i més gruixut cap el Sud). El pendent Nord/Sud (Fig. 6) es més suau, mentre que l'Est/Oest (Fig. 4) baixa més pronunciat. Al punt on convergeixen es forma una cunya que baixa força, trencant als quadres 263,556 i 264,556.

La morfologia de la planta H-2 està destruïda en la zona més pròxima a l'Est, desconeixent si és a conseqüència dels treballs d'extracció de la coberta vegetal o realment respón a la morfologia original de l'estructura. Els límits en planta es van determinar per canvi sedimentològic i l'associació de pedres de gran tamany, que no es troben en cap lloc més del nivell.

Les seves dimensions aproximades són uns 30 m<sup>2</sup> (6 m. E/W i 5 m. N/S) i probablement es tracta de la reutilització d'una estructura d'habitació més antiga amb una estructuració interna de l'espai pròpia (Fig. 7).

El total d'objectes coordinats d'aquest nivell arqueològic es de 3889, la distribució en el pla horitzontal es pot veure a la figura 8 es reparteixen en les següents categories:

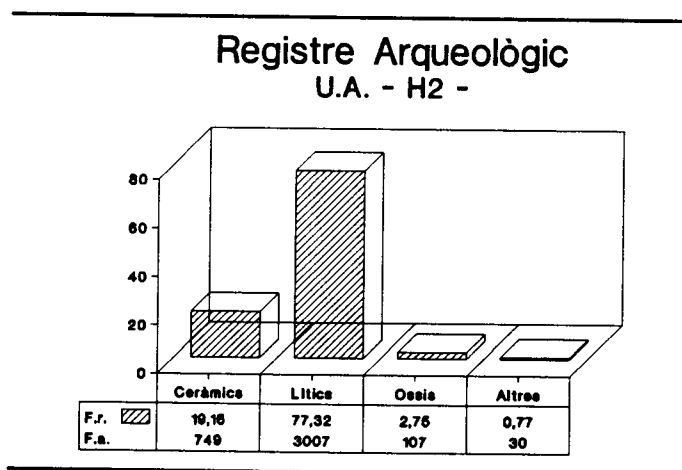

### SS 262 /263 Total Objectes

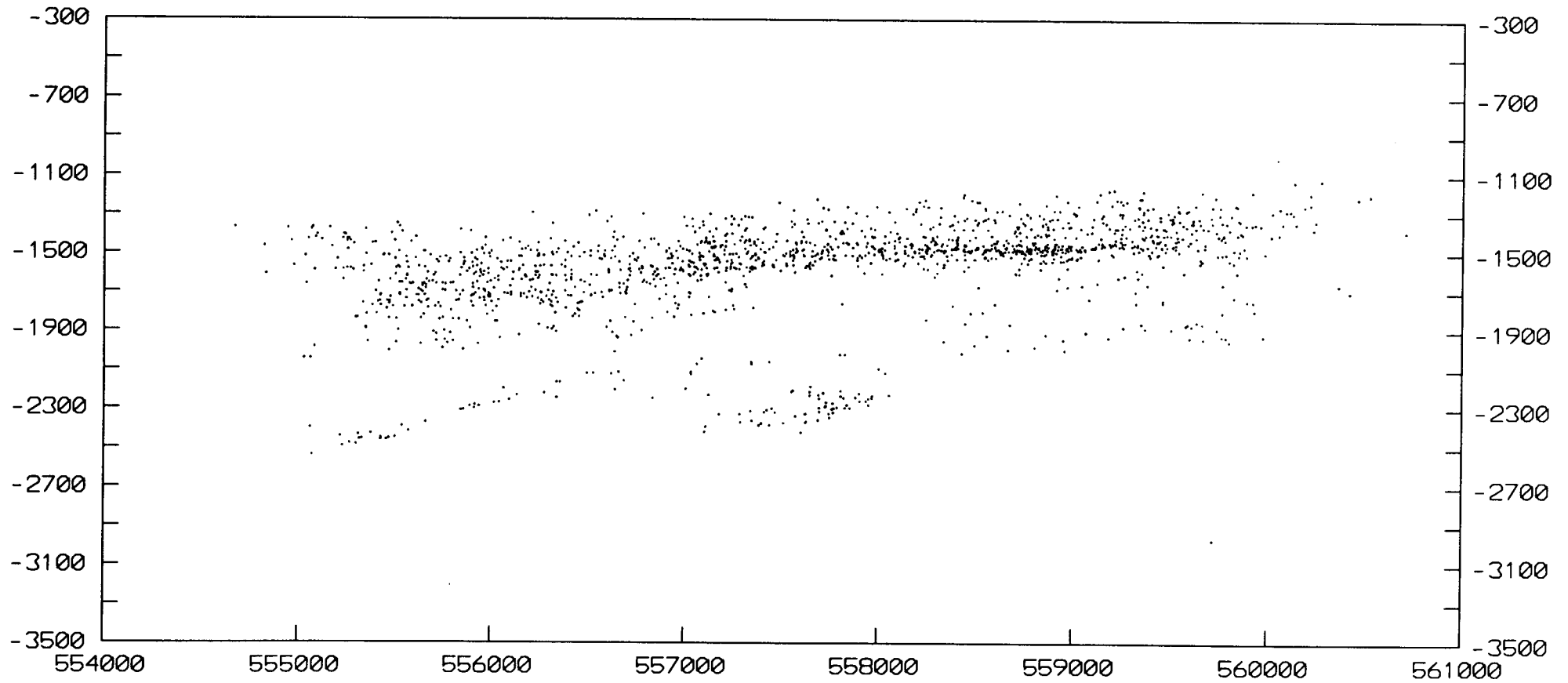



Fig. 7. - Planta general amb les estructures internes del Nivell Arqueològic H-2.

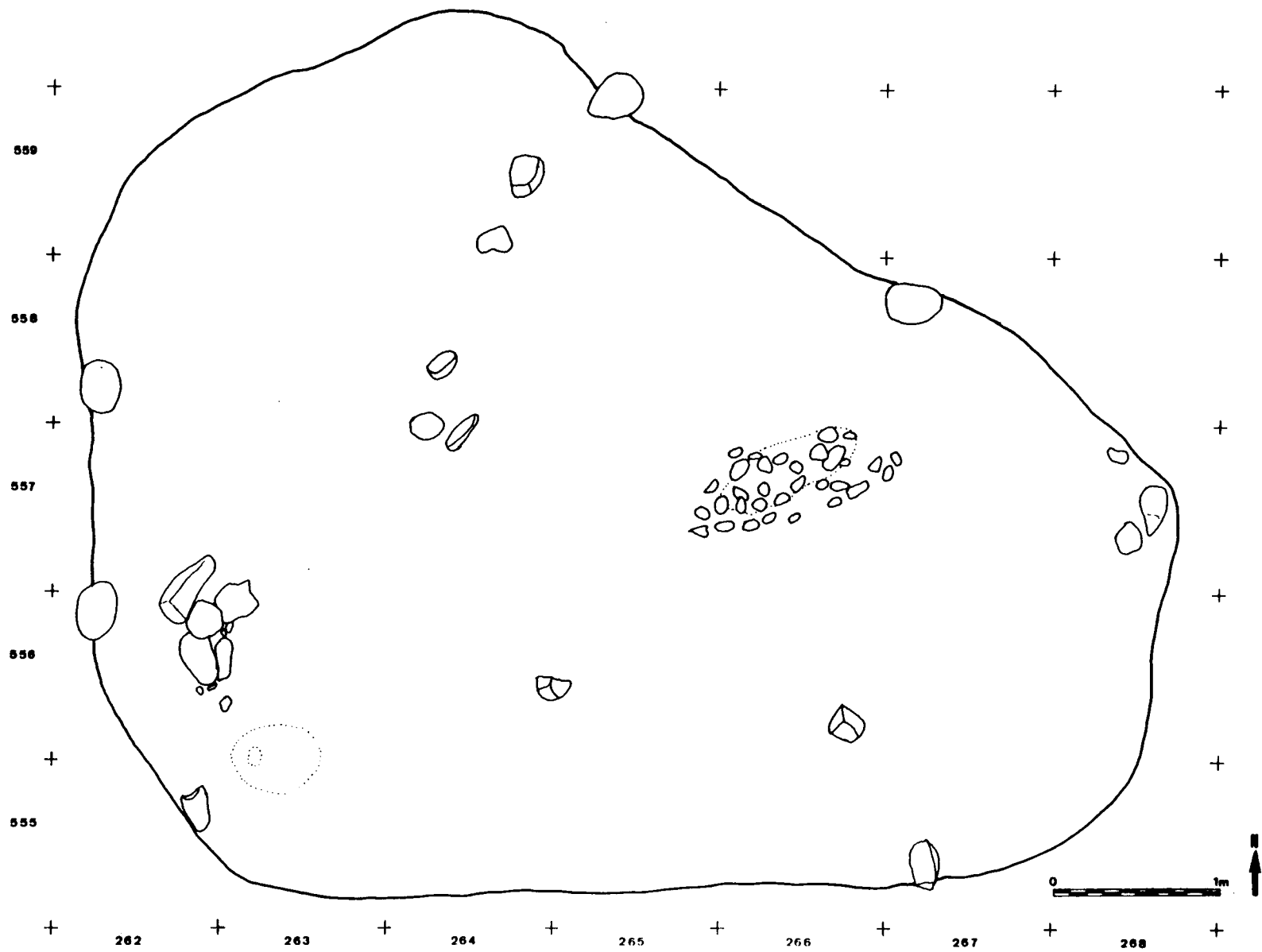
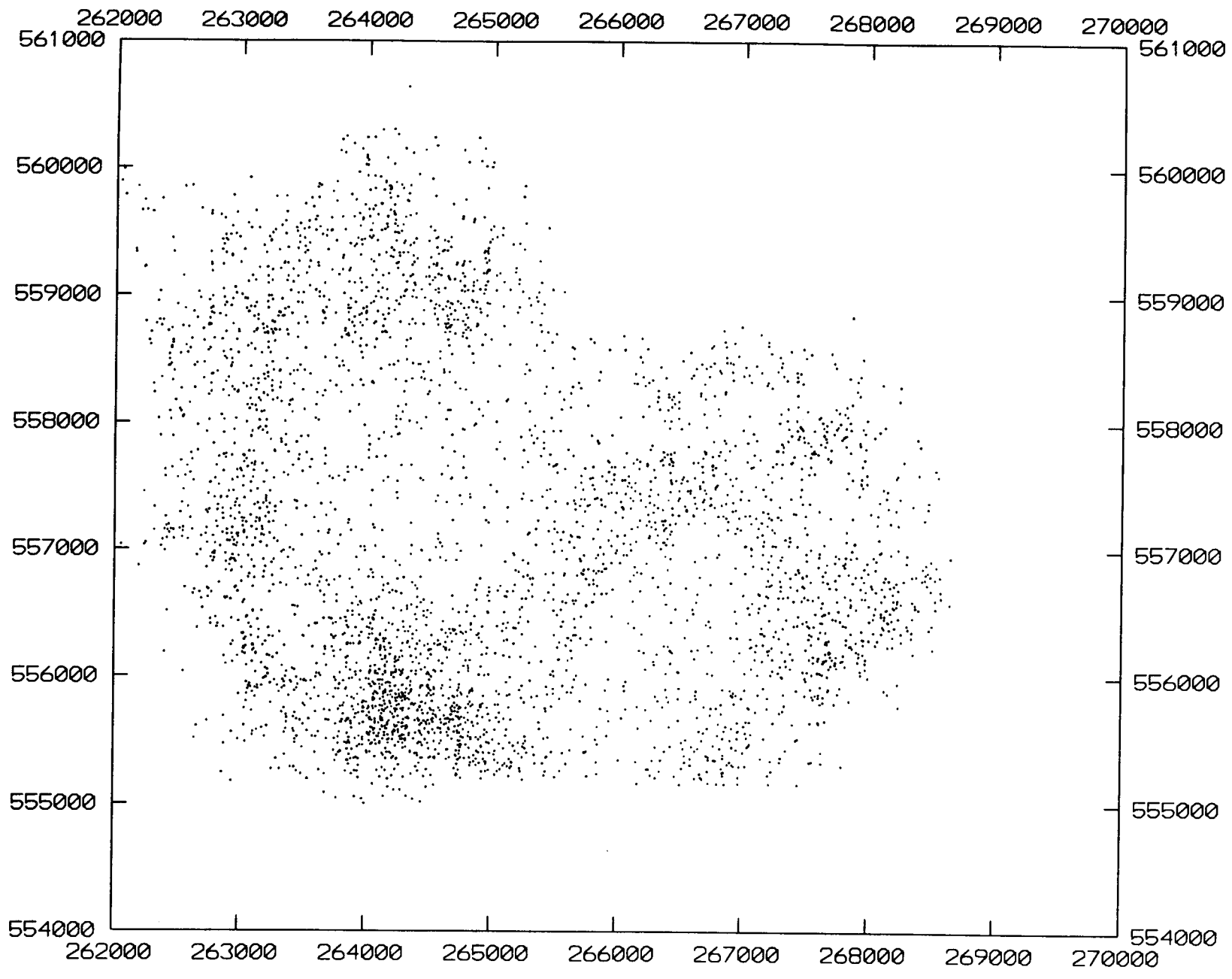

Fig. 8.- Distribució en planta del material arqueològic del nivell H-2.



Tal com podem veure, són les restes lítiques l'element més dominant, seguit de ceràmiques i restes òssies. A l'apartat "d'altres" s'inclouen les categories de tovot, ocre i carbons que han estat coordinats.

Les restes lítiques que participen de la Cadena Operativa (BP, BP2G, BPI, BPF, BN1G, BN2G, BNE) representen el 15.26% sobre el total del material lític, mentre que la resta de categories, és a dir, aquells que no formen part de la Cadena Operativa Lítica, com BNA, fragments i plaquetes, els hi correspon el 84.74%.

RESTES LITIQUES	BP	BP2G	BPF	BPI	BN1G	BN2G	BNA	BNE
CALCÀRIA	43	-	54	29	23	2	291	-
CONGLOMERAT	-	-	-	-	-	-	177	1
ESQUIST	-	-	-	-	-	-	114	-
GRANIT	-	-	-	-	-	-	17	1
INDET	2	-	1	1	1	-	100	3
PISSARRA	-	-	-	-	-	-	5	-
QUARS	11	5	36	93	11	3	571	-
QUARSITA	-	1	4	10	5	-	94	2
RMI	4	-	6	3	2	-	558	2
SILEX	6	6	19	21	11	16	11	-
SORRENCA	5	-	9	1	-	-	611	5
<b>TOTAL</b>	<b>71</b>	<b>12</b>	<b>129</b>	<b>158</b>	<b>53</b>	<b>21</b>	<b>2553</b>	<b>14</b>

Les ceràmiques representen un 19.1% del total d'objectes de l'H-2, de les quals únicament el 14% són restes determinables, destacant vores i aplicacions (mamelons i llengüetes).

Restes ceràmiques	Informe	Aplica	Carena	Nansa	Panxa	Vora
F.a.	640	37	2	1	10	55
F.r.	85.9	4.96	0.26	0.13	1.34	7.38

Les restes òssies són el 2.75% del total del material. Aquests es reparteixen en un 48% d'ossos determinables i en un 52.4% d'indeterminables.

Per les formes de les ceràmiques i pel tipus de decoració s'ha situat cronològicament dins del Neolític Final, concretament el Grup Veraza, per la constant presència de mamelons superposats i vasos de ceràmiques de dimensions considerables.

D'aquest nivell es van recollir carbons i restes malacològiques per talles de 10 cms, podent-se observar l'existència de diferents tipus de cargols. Si bé es documenta la presència de zones d'una major concentració de carbons, en general aquests es distribuïen per tot el sediment.

Es van determinar una sèrie d'estructures internes:

- Una estructura de combustió composta de pedres sense una distribució definida però associades a una concentració important de carbons, ocre i terra rubefectada (Fig. 9). D'aquesta estructura s'han recollit pedres per a un anàlisi de greixos.

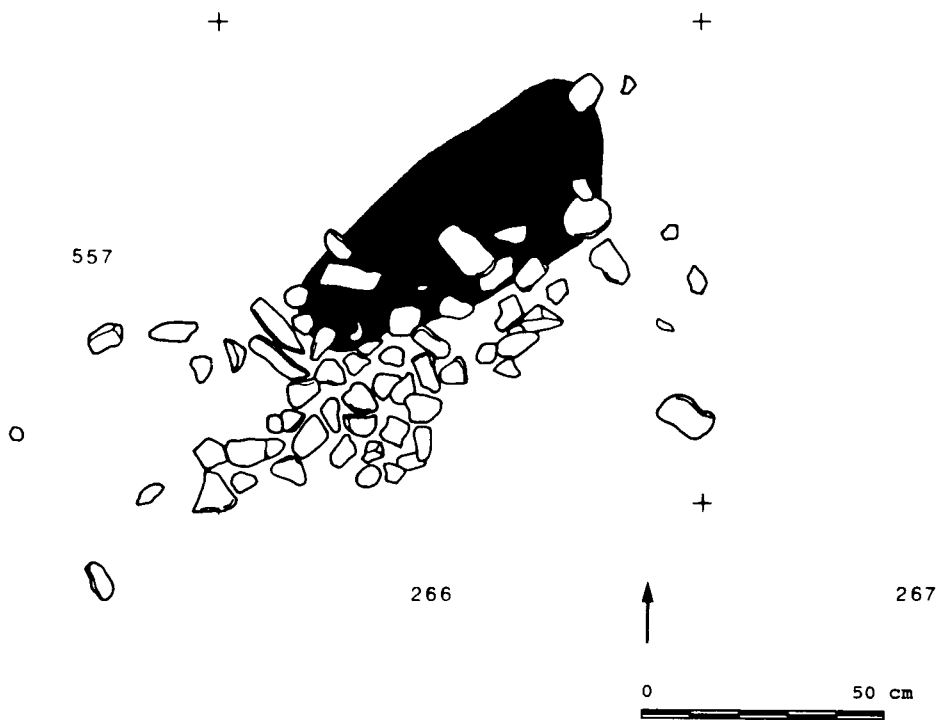

Fig. 9.- Estructura de combustió del nivell Arqueològic H-2.

- dos forats de pal construïts amb pedres de diferents tamanys i una gran pedra de falcament (Figs. 10 i 11).

556



555



Fig. 10.- Forat de pal del Nivell Arqueològic H-2. Quadres 267,555 i 267,556.

557

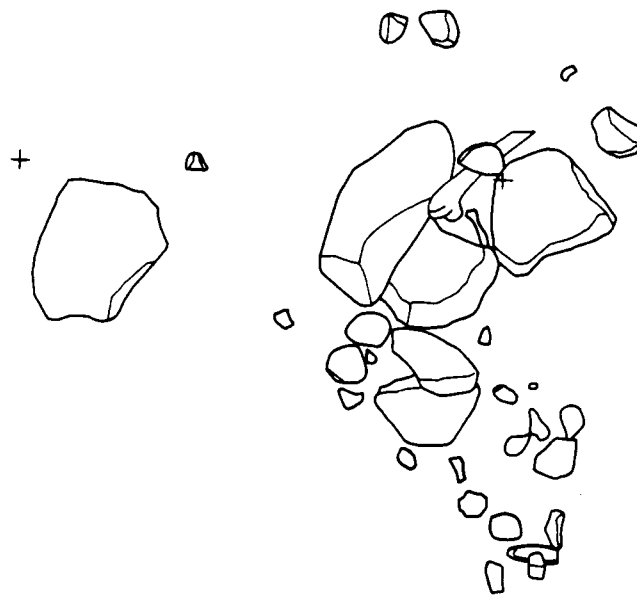

556

262



Fig. 11.- Forat de pal del Nivell Arqueològic H-2. Quadres 262,556.

- una petita fossa circular d'uns 50 cms de diàmetre màxim i uns 12 cms. de fondària excavada a les argiles marrons reomplerta de terra rubefectada i carbons. A la zona Oest de la base va aparèixer un forat de petites dimensions (15 cms. de diàmetre) reomplerta pel mateix sediment. No contenia cap tipus de material arqueològic, per la qual cosa fa difícil determinar la seva funcionalitat (Fig. 12).

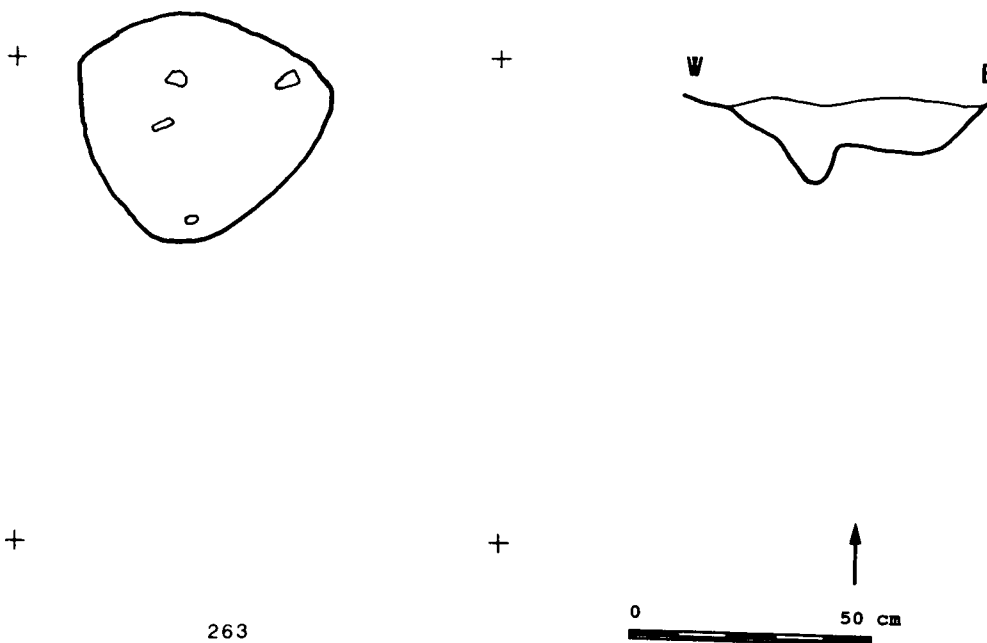

555

Fig. 12.- Planta i secció de la fossa del Nivell Arqueològic H-2. Quadre 263,555.

- Fossa circular de 1,20 m. de diàmetre màxim (quadres 264,555 i 264,556) i una potència de 50 cms. Excavada també a les argiles marrons, al seu interior trobem argiles amb molta matèria orgànica i material arqueològic. Cap el final de la fossa la fossa apareixia rubefectada i amb grans quantitats de carbons (Fig. 4).

El pas del nivell arqueològic H-2 a l'H-3 ve marcat per l'absència de material arqueològic, així com per una capa prima de sediment d'uns 5 cms. plena de d'origen físico-químic.

### IV.3.- NIVELL ARQUEOLÒGIC H-3

Correspón a l'ocupació més antiga de l'estructura d'habitació. Els seus límits externs responen sedimentològicament al subsòl quaternari i està dins d'argiles taronges. Te unes dimensions de 7 m. de llargada (E-W) per uns 8 m. d'amplada (N-S), representant aproximadament uns 56 m<sup>2</sup>.

La seva individualització en el pla horitzontal va resultar complexa ja que es trobava en algunes parts malmesa per l'ocupació de l'H-2.

A la base del nivell vam detectar que a la zona Est aflorava el tortorà a una profunditat de 177,78 m. s.n.m. de promig amb un lleuger pendent cap a l'Oest (Fig. 13), essent estèril en aquest nivell. Com comprovació es va realitzar un sondeig en el quadre 267,557 d'1 m. de fondària que també va donar estèril. En canvi cap a l'Oest (aproximadament a la meitat de la estructura d'habitació, l'eix de la x=264 i de la x=265) el funcionament era diferent: el tortorà desapareixia i la base estava a major profunditat (178,10 m. s.n.m. de promig) provocant un desnivell. En aquesta zona la base es caracteritza per les argiles vermelles i el material sembla funcionar per concentracions aïllades que podrien resultar ésser fosses de difícil diferenciació sedimentològica (Fig. 14).

La distribució del material arqueològic en planta es pot veure a la figura 15 i es reparteix en les següents categories:

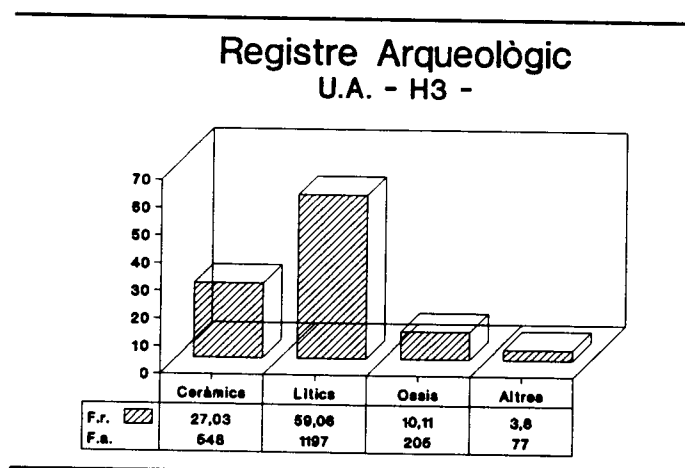
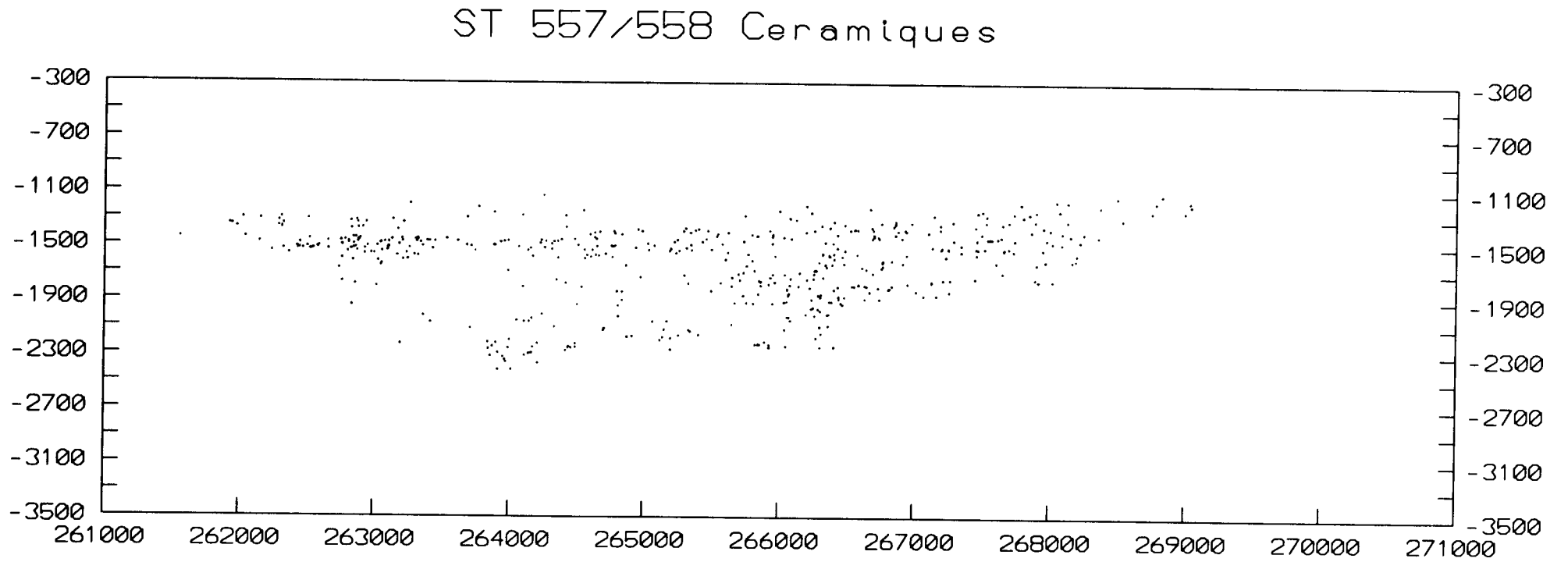



Fig. 13. - Secció Transversal del registre arqueològic dels quadres Y=557 i Y=558 del Nivell H-3.



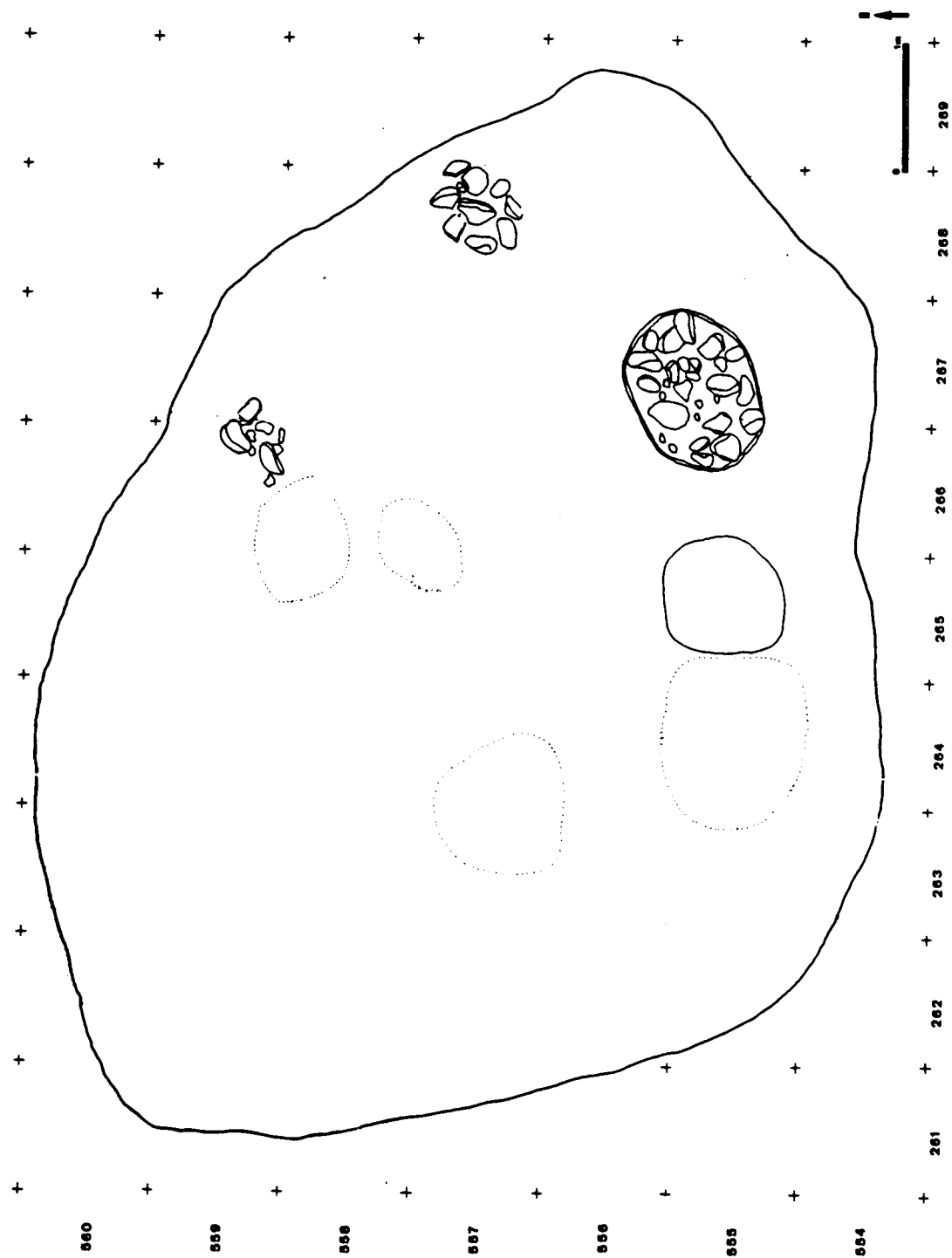
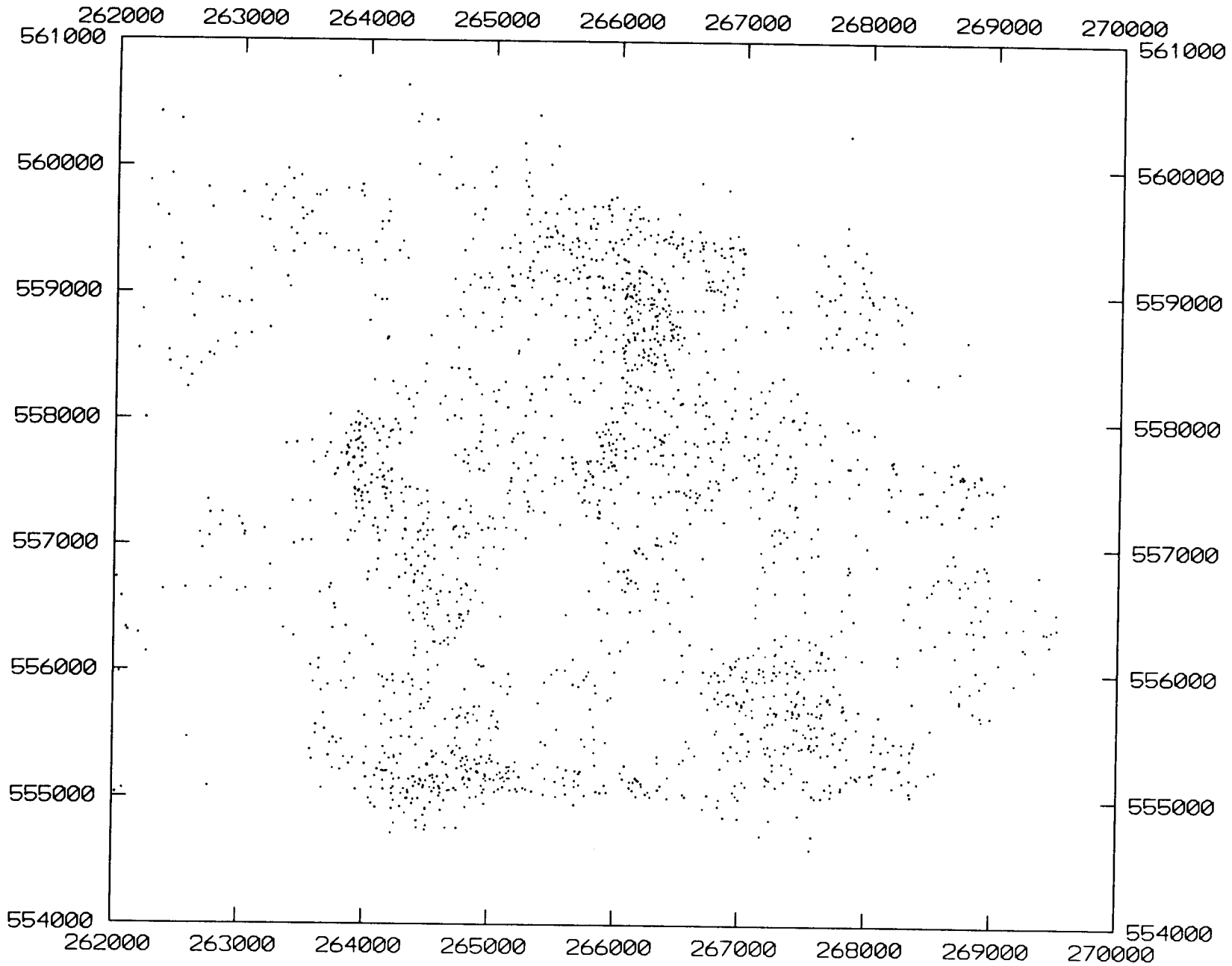

Fig. 14.- Planta general amb les estructures internes del Nivell Arqueològic H-3.

Fig. 15. - Distribució en planta del material arqueològic del nivell H-3.



A l'igual que en l'H-2, les restes lítiques són la categoria dominant, seguida de les restes ceràmiques i òssies.

RESTES LITIQUES	BP	BP2G	BPF	BPI	BN1G	BN2G	BNA	BNE
CALCÀRIA	10	-	14	5	6	1	155	-
CONGLOMERAT	-	-	-	-	-	-	113	2
ESQUIST	-	-	-	-	-	-	37	-
GRANIT	-	-	-	1	-	-	5	-
INDET	-	-	-	1	-	-	25	-
LIDITA	-	-	-	1	-	-	2	-
PISSARRA	-	-	-	-	-	-	2	-
QUARS	6	1	6	21	2	-	146	-
QUARSITA	-	-	5	2	1	-	35	-
RMI	3	-	14	5	1	-	395	6
SILEX	5	4	3	3	-	4	5	-
SORRENCA	-	-	-	-	-	-	143	1
<b>TOTAL</b>	<b>24</b>	<b>5</b>	<b>42</b>	<b>39</b>	<b>10</b>	<b>5</b>	<b>1063</b>	<b>9</b>

Les restes lítiques que conformen la Cadena Operativa Lítica representen el 11.20% (134) mentre l'altre grup són el 88.80% (1063).

Les restes ceràmiques representen el 27.03% del total d'objectes documentats en aquesta unitat arqueològica, de les que únicament el 21% són determinables.

Restes ceràmiques	Informe	Aplica	Carena	Panxa	Vora
F.a.	433	38	1	15	61
F.r.	79.01	6.93	0.18	2.73	11.13

Del total de restes òssies documentades (205), el 63.1% són determinables i el 32.68% són indeterminables.

A l'igual que el nivell arqueològic H-2, l'H-3 es pot situar cronològicament per les formes ceràmiques i decoracions dins del Neolític Final, grup Veraza.

Les estructures internes que componen aquest nivell arqueològic són:

- dues llars que per les seves dimensions i característiques podrien tenir unes funcions diferents. Si bé les dues estaven excavades al tortorà, una, l'H-3.1, estava reomplerta de pedres de gran tamany ( més de 10 cm.) i carbons, fins i tot es podia reconèixer troncs. L'altre, H-3.2 no presentava pedres, però la terra estava totalment rubefactada. Al costat Oest de l'H-3.2 va aparèixer una concentració de carbons amb material que podria correspondre a un buidament de la llar, explicant perquè aquesta no presentava gairebé cap carbó ( Fig. 16 i 17). De la llar H-3.1 es va realitzar un motlle amb silicones pels especialistes del Centre de Restauració de Sant Cugat.

556

555

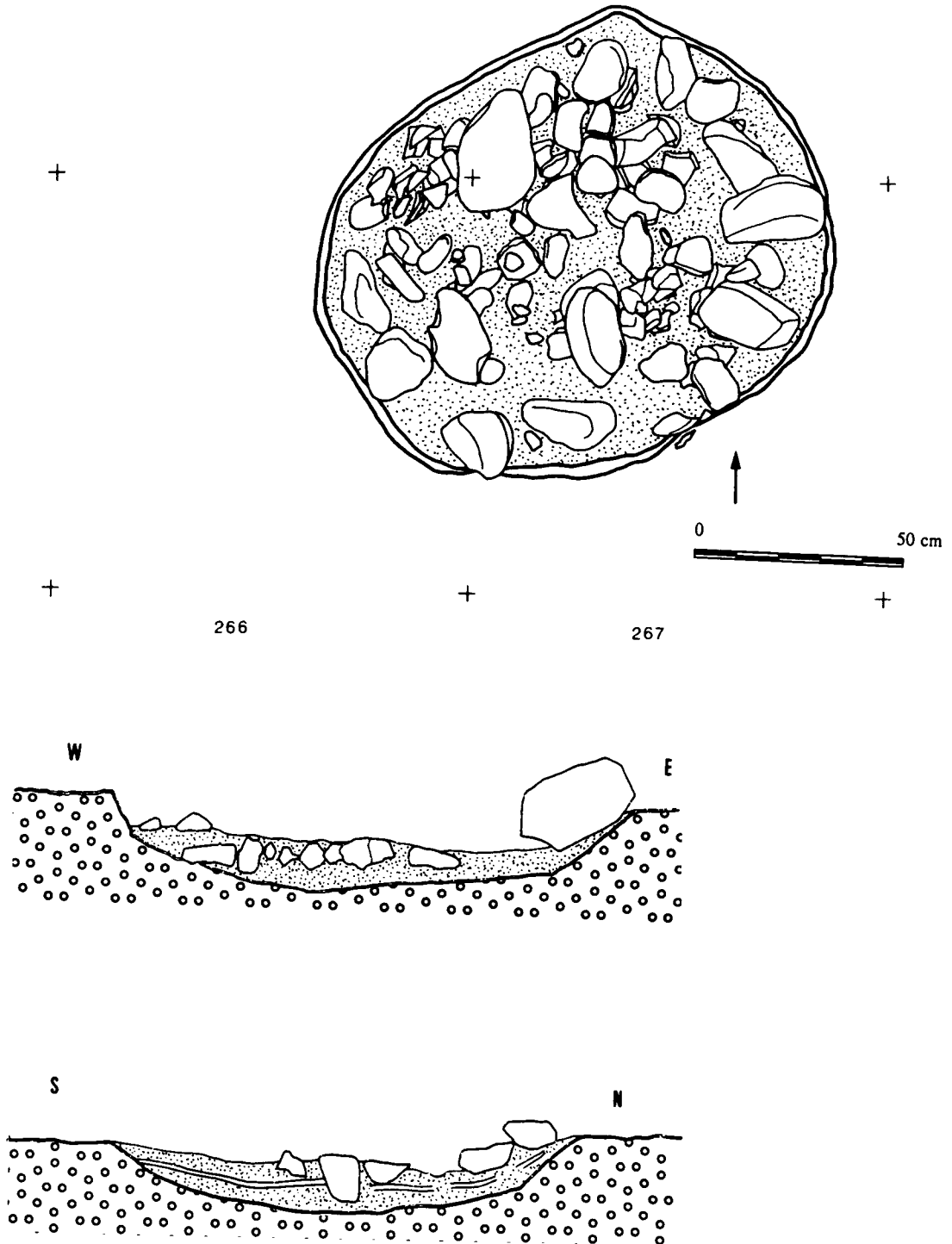

Fig. 16.- Planta i secció de la llar H-3.1.

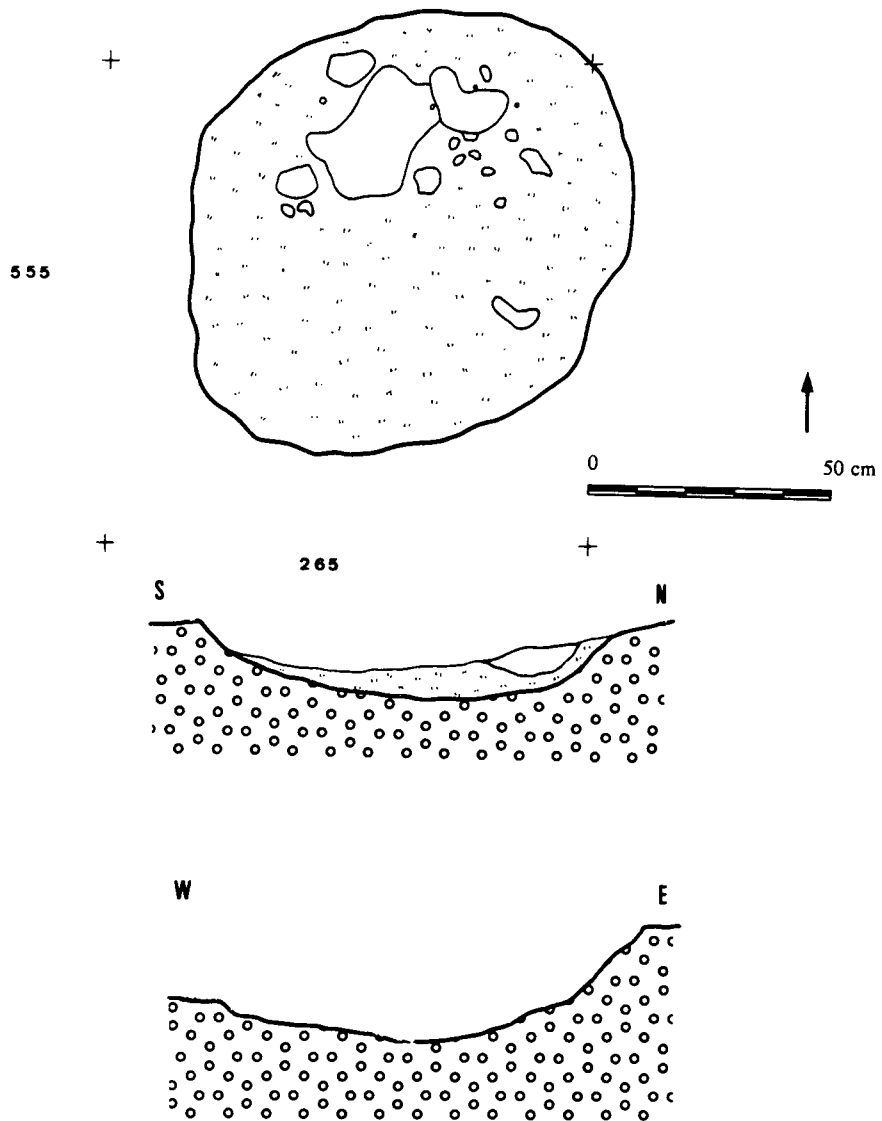

Fig. 17.- Planta i secció de la llar H-3.2.

- dues estructures de sosteniment compostes per pedres de gran tamany ( més de 15 cms.). Una es troba al Nord i l'altre a l'Est. No s'ha determinat cap al Sud. Aquí és on es localitzen les dues llars, el que ens fa pensar que, atesa la necessitat de ventilació d'aquesta zona, la cabana estaria en part al descobert (Fig. 18 i 19).

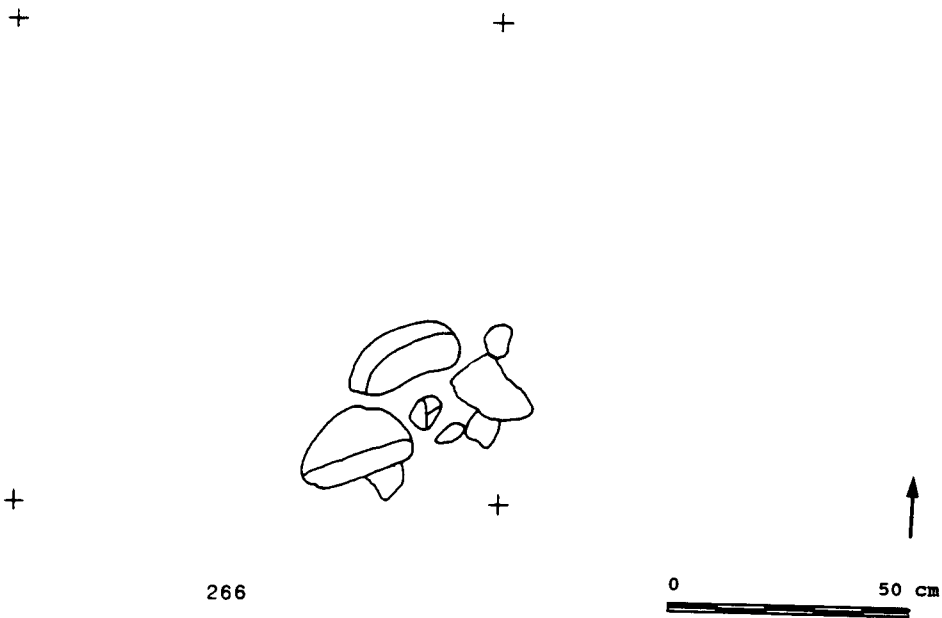

Fig. 18.- Forat de Pal del Nivell Arqueològic H-3. Quadre 559.

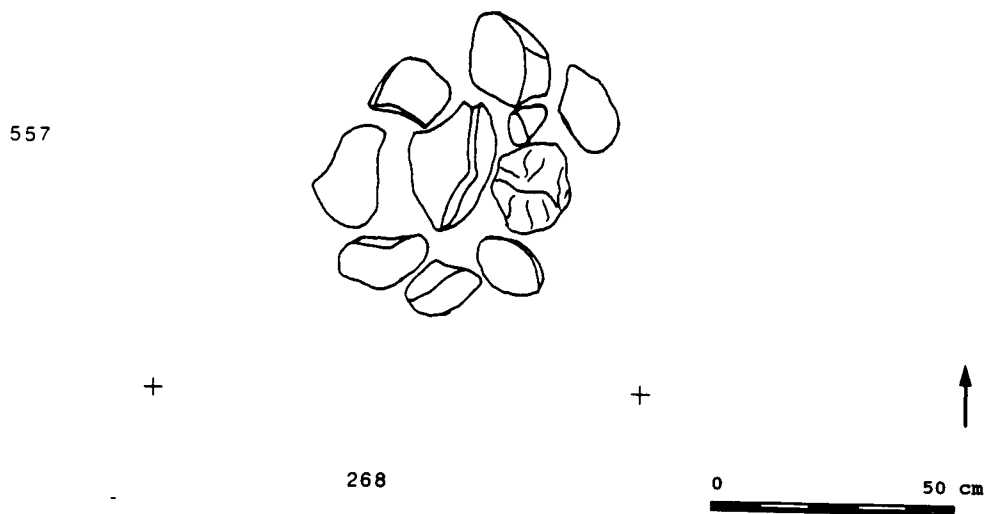
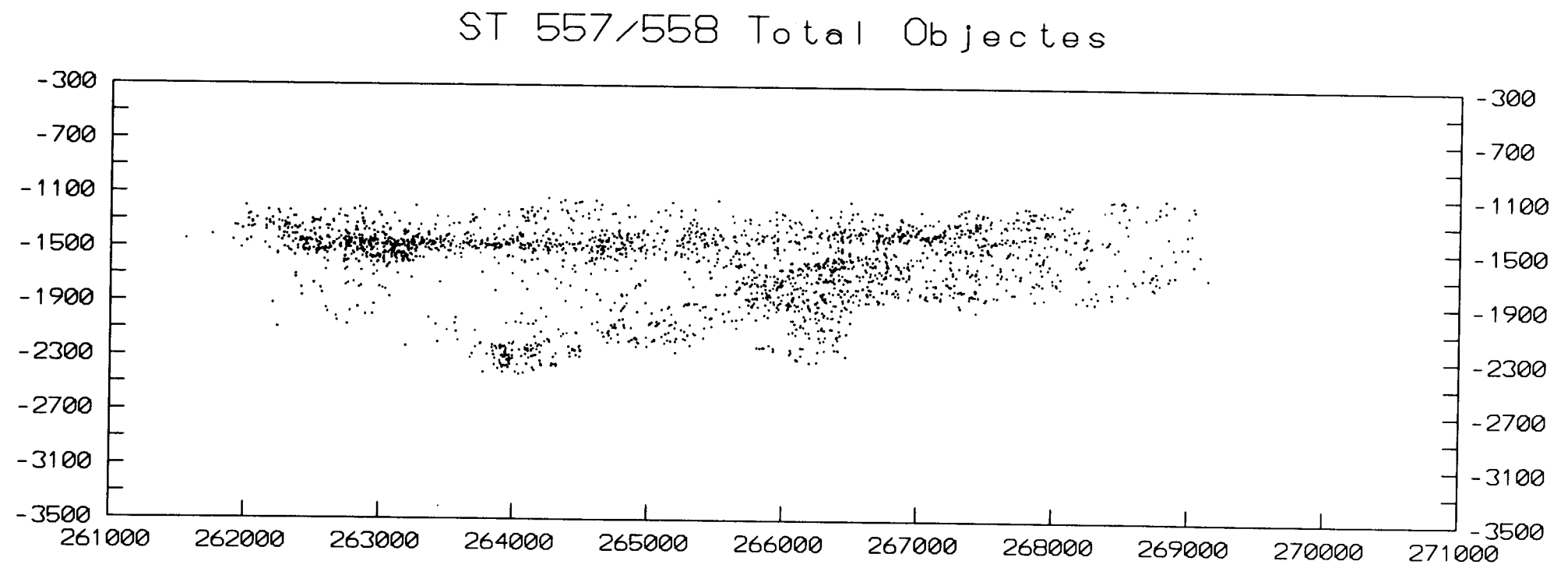

Fig. 19.- Forat de Pal del Nivell Arqueològic H-3. Quadre 268,557.



- dues fosses excavades a les argiles vermelloses. Una situada als quadres 265,557/558 i 266,557/558 de la qual no es va trobar el canvi sedimentològic, però que contenia part d'un bou en connexió anatòmica ( mandíbules, vèrtebres i costellam) així com tovots. L'altre se situa en els quadres 266,558/559 i 265,558/559. Es va diferenciar pel sediment i tenia unes dimensions de 115 cms de diàmetre i 20 cms de fondària. La gran part del material arqueològic eren pedres i ceràmiques, destacant la inexistència d'ossos (Fig. 20 i 21).

Fig. 20.- Secció transversal de l'eix de la Y = 557 i Y = 558.



ST 558/559 Total Objectes

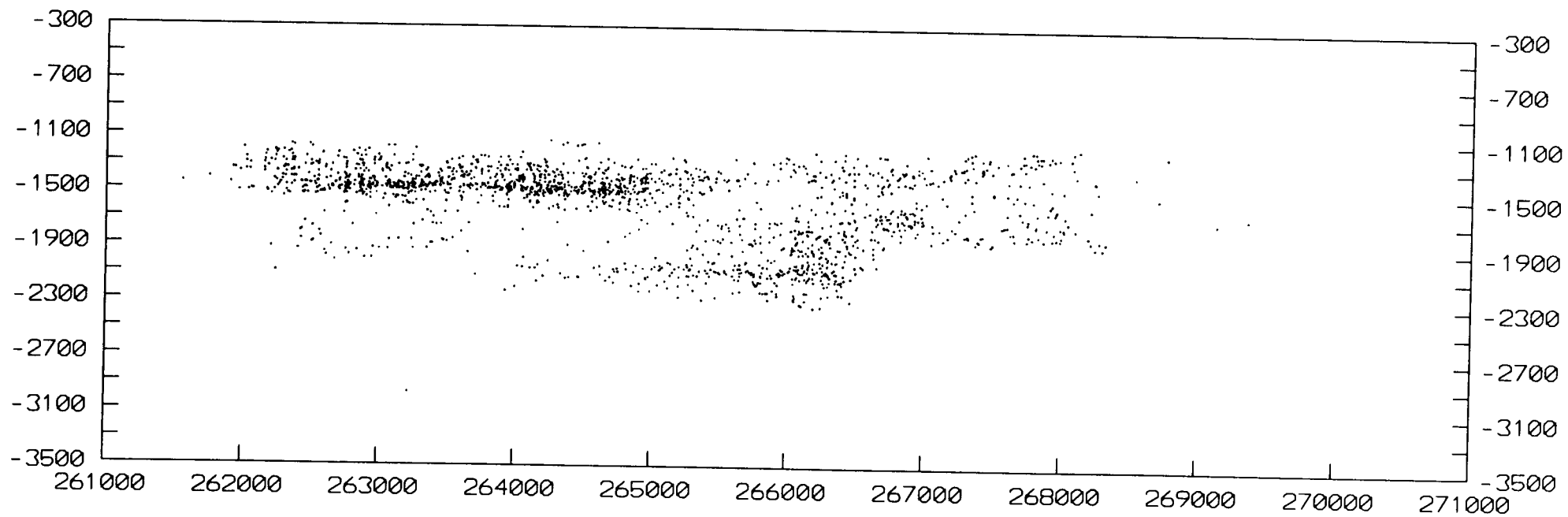

Fig. 21.- Secció transversal de l'eix de la Y = 558 i Y = 559.

## V.- ESTRUCTURES D'EMMAGATZEMATGE

En aquest apartat tractarem de les fosses d'emmagatzematge, tant si la seva funció original era la de sitja com si era una altra. L'anàlisi d'aquestes estructures el farem separant-les per les zones del jaciment on s'han localitzat, és a dir, els diferents carrers i illes.

### V.1.- CARRER 7

S'han trobat cinc estructures d'emmagatzematge (Fig 22), excavades en el subsòl d'argiles grogues amb nòduls de carbonat (tortorà) i reomplertes d'argiles fosques i material arqueològic.

Després d'una primera revisió del material, sobretot de les ceràmiques, s'ha pogut constatar que:

- les estructures 7.2, 7.3 i 7.4 poden situar-se cronològicament dins del període Neolític Mig Recent (Grup dels Sepulcres de Fossa), presentant ceràmiques llises, d'altres amb decoracions Chassey (amb incisions internes), vasos carenats de petites dimensions amb nanses horitzontals tubulars perforades, acompanyades d'indústria lítica sobre sílex melat (làmines i peces retocades) i indústria òssia (punxons).
- l'estructura 7.5 és una fossa de petites dimensions que no presenta ceràmica determinable, però que per proximitat a les altres tres pot ser considerada del mateix període.

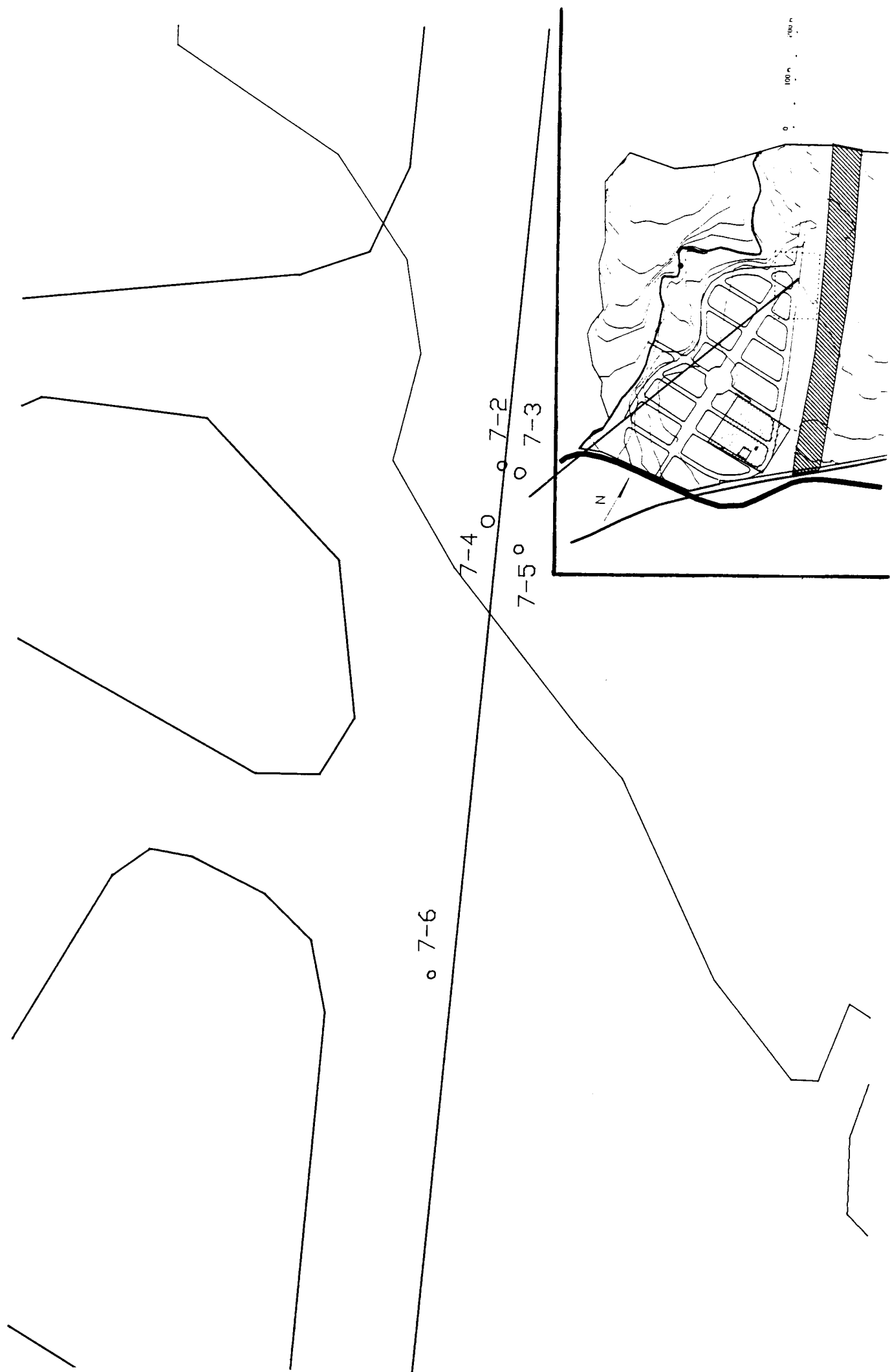
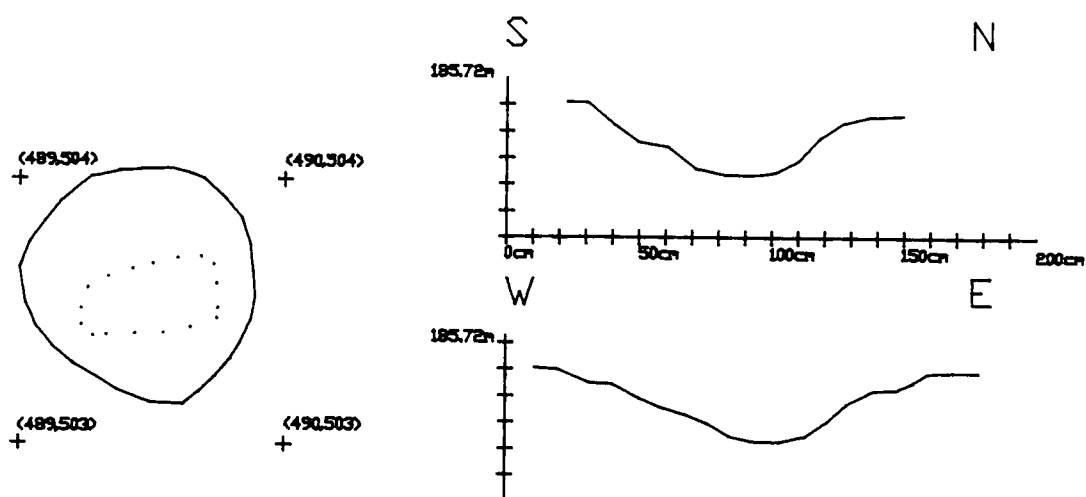

Fig. 22.- Localització de les estructures d'emmagatzematge al carrer 7.

- l'estructura 7.6 tampoc presenta ceràmica determinable i a més es troba allunyada de les altres per la qual cosa es fa difícil associar-la a un moment cronològic concret.

Pel que fa a la tipologia d'aquestes estructures no es pot parlar d'uniformitat encara que la 7.3 i 7.4 presenten característiques comunes essent les més profundes amb uns 50 centímetres de potència, planta circular i fons pla (Figs. 23,24,25,26 i 27). Les estructures 7.2, 7.5 i 7.6 presenten només el fons en forma de cubetes amb una potència que oscil·la entre els 10 i els 25 cms., però que segurament deuriem ser més profundes originalment, trobant-se en l'actualitat més arrasades.

## ESTRUCTURA 7.2



## ESTRUCTURA 7.2

Punt Zero = 185.21 m.  
Nivell a 1.80 m.

Talles	5	6	7	8	TOTAL
Ceràmica	17	25	3	2	47
Os		2	5	1	8
Sílex		1	1		2
Sorrenca			1		1
<b>Total</b>	<b>17</b>	<b>28</b>	<b>10</b>	<b>3</b>	<b>58</b>

Fig. 23.- Planta, seccions i repartició per talles i matèries del registre arqueològic de l'estructura 7.2

## ESTRUCTURA 7.3

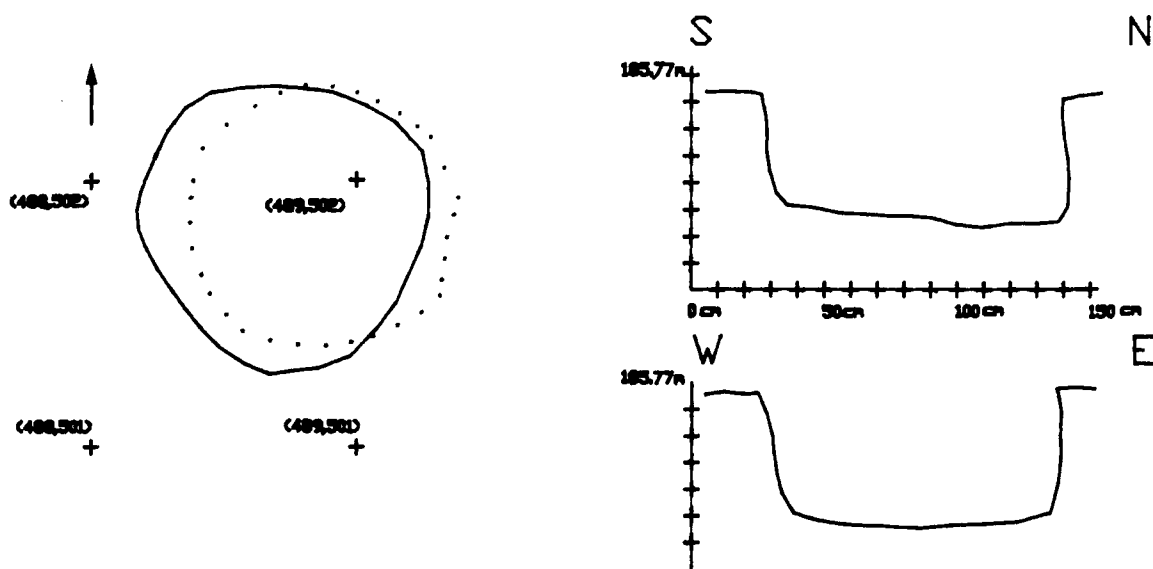

### ESTRUCTURA 7.3

Punt Zero = 185.21 m.  
Nivell a 1.80 m.

Talles	6	7	8	9	10	11	TOTAL
Ceràmica	18	113	89	18	139	32	409
Conglomerat	2	2	1		4		9
Os	1	29	10	16	40	9	105
RMI	2	3	1		13	1	20
Sílex	1	4	5	5	7	2	24
Ind. òssia	3						3
Sorrenca	2	9	8		9	2	30
Altres		1 Indet			Esquist 7 Indet	1 Indet	9
Quars		1	2	1	3		7
Tovot		1	2				3
Calcària			1		2		3
Orgànic				1 Molusc	2 Molusc		3
Calaita					1		1
<b>Total</b>	<b>29</b>	<b>163</b>	<b>119</b>	<b>41</b>	<b>227</b>	<b>47</b>	<b>626</b>

Fig. 24.- Planta, seccions i repartició per talles i materies del registre arqueològic de l'estructura 7.3



## ESTRUCTURA 7.4

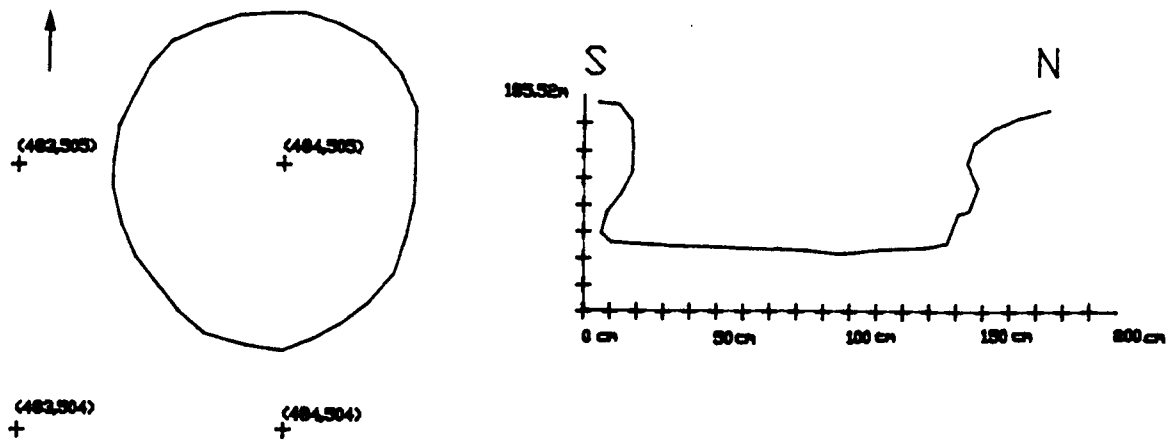

### ESTRUCTURA 7.4

Punt Zero = 185.21 m.  
Nivell a 1.80 m.

Talles	0	8	9	10	11	12	13	14	TOTAL
Os	8	8	3	8	43	34	29	1	134
Ceràmica		3	5	5	16	17	12		58
Conglomerat		1							1
Quars		1	1						2
RMI		1	4			4	2		11
Silex		2		2	3	1			8
Sorrenca		3	3	2		3	1		12
Calcària			1	1					2
Altres				Esquist 3 Quarsita		Quarsita 4 Cristall Roca Esquist			7
Orgànic					1 Molusc	1 Molusc			2
Ind. òssia						1			1
Tovot							1		1
<b>Total</b>	<b>8</b>	<b>19</b>	<b>17</b>	<b>21</b>	<b>63</b>	<b>65</b>	<b>45</b>	<b>1</b>	<b>239</b>

Fig. 25.- Planta, seccions i repartició per talles i materies del registre arqueològic de l'estructura 7.4

# ESTRUCTURA 7.5

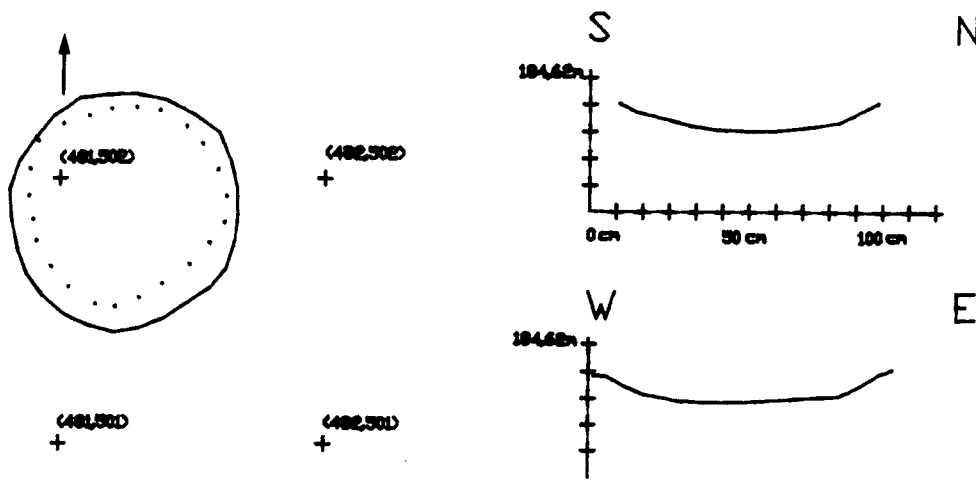

## ESTRUCTURA 7.5

Punt Zero = 185.21 m.  
Nivell a 1.80 m.

Talles	8	TOTAL
Ceràmica	1	1
Esquist	1	1
Quars	2	2
<b>Total</b>	<b>4</b>	<b>4</b>

Fig. 26.- Planta, seccions i repartició per talles i materies del registre arqueològic de l'estructura 7.5

# ESTRUCTURA 7.6

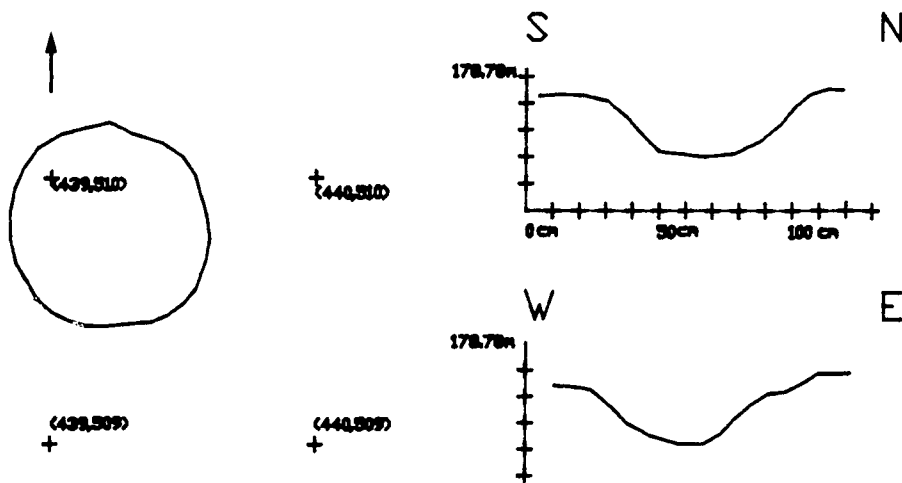

## ESTRUCTURA 7.6

Punt Zero = 185.21 m.  
Nivells a 1.80 m.

Talles	4	5	6	7	8	TOTAL
Calcària	1					1
Ceràmica	15	8	1			24
Os	1	1	2			4
Quars	3	1		4	1	9
RMI	4	1				5
Sílex	3					3
Sorrencia	1					1
Altres		1 Granit	1 Granit			2
<b>Total</b>	<b>28</b>	<b>12</b>	<b>4</b>	<b>4</b>	<b>1</b>	<b>49</b>

Fig. 27.- Planta, seccions i repartició per talles i materies del registre arqueològic de l'estructura 7.6

## V.2.- CARRER 10

En aquest carrer s'han trobat cinc estructures d'emmagatzematge (Fig. 28) excavades en el subsòl d'argiles grogues amb nòduls de carbonat i reblertes d'argiles taronges i material arqueològic. La similitud del sediment intern i extern de les fosses en aquesta zona del jaciment i el fet de trobar una petita dispersió de material al seu voltant va dificultar la identificació i delimitació de les estructures existents.

Un estudi preliminar del material ens permet atribuir-les cronològicament al període Neolític Final-Bronze, per l'absència de ceràmiques decorades i la presència d'aplicacions (llengüetes i mamelons) i nanses de cinta, encara que la falta de material amb trets molt característics no permet de moment fer una atribució més concreta de cada una de les estructures. La indústria lítica, sobre diferents tipus de sílex, presenta molt poca talla laminar.

Tipològicament presenten totes una secció semblant amb el fons en forma de cubeta i planta circular. Varien considerablement en les seves dimensions, essent les de major tamany les 10.2 i 10.4 ( amb un diàmetre màxim a la seva obertura de 173 i 216 cms respectivament). Aquesta última es troba reomplerta de pedres d'un tamany aproximat entre 10 i 20 cms. La 10.1 10.3 són més petites ( 136 i 109 cms. de diàmetre màxim a la seva obertura).

D'aquest grup cal diferenciar la 10.5 que sembla correspondre a dues fosses que es tallen, una d'elles amb el fons pla i l'altre amb el fons en cubeta, essent aquesta la que tallaria a la primera.

La fondària d'aquestes estructures no passa de 20 cms (excepte la 10.5 que arriba als 30 cms) el que ens mostra clarament l'avançat grau d'arrasament en que es troben. (Figura 29,30,31,32 i 33).

Fig. 28. - Localització de les estructures d'emmagatzematge al carrer 10

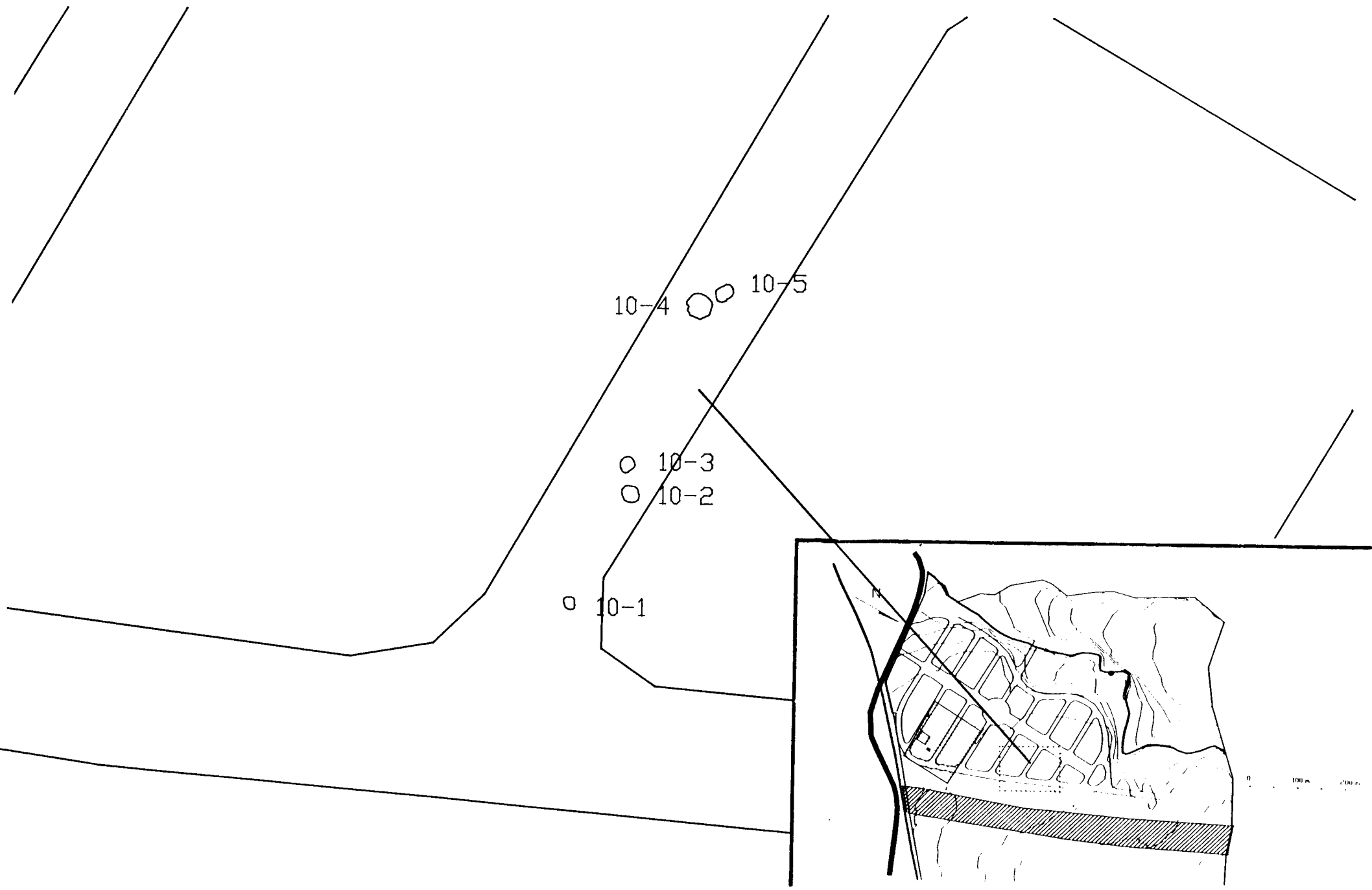

## ESTRUCTURA 10.1

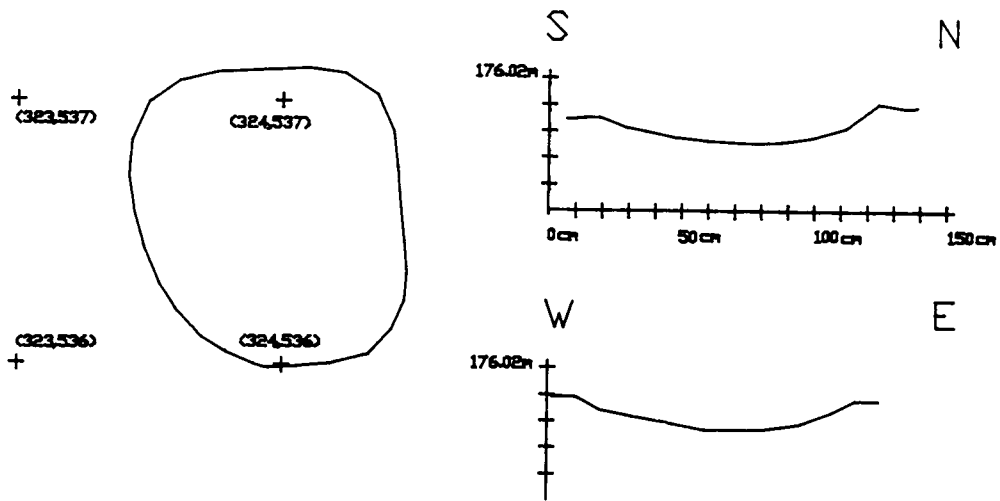

## ESTRUCTURA 10.1

Punt Zero = 177.32 m.  
Nivell a 0.50 m.

Talles	19	20	21	TOTAL
Calcària	1	2		3
Ceràmica	20	19		39
Conglomerat	2	1		3
Os	2	2		4
Quars	3	1	3	7
RMI	11	8	7	26
Sorrenca	3	2	2	7
Altres		Granit 2 Esquist	2 Granit	4
Orgànic		1		1
Silex		2		2
<b>Total</b>	<b>42</b>	<b>40</b>	<b>14</b>	<b>96</b>

Fig. 29.- Planta, seccions i repartició per talles i materies del registre arqueològic de l'estructura 10.1

## ESTRUCTURA 10.2

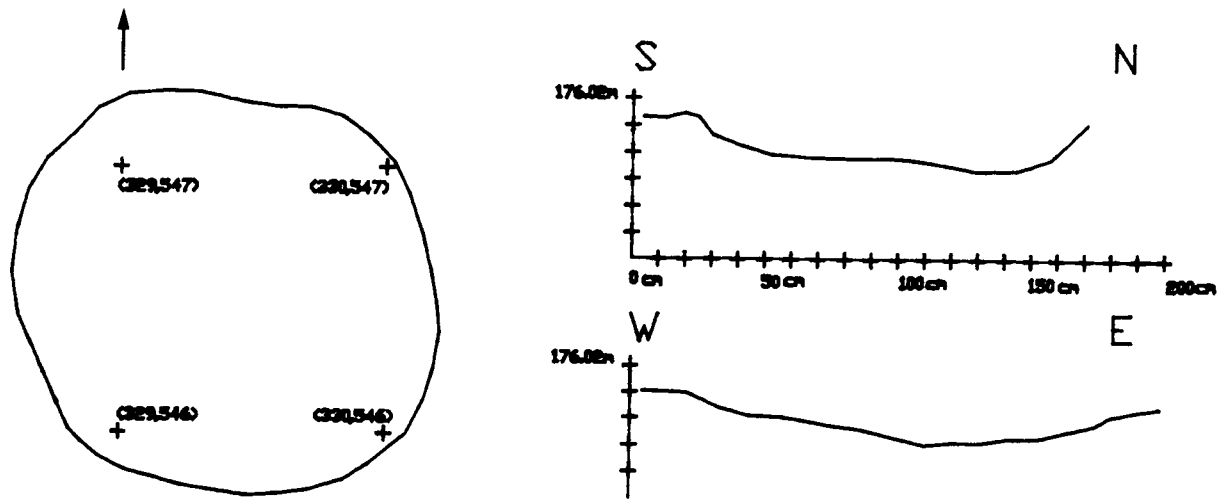

### ESTRUCTURA 10.2

Punt Zero = 177.32 m.  
Nivell a 0.50 cm.

Talles	0	18	19	20	21	TOTAL
Altres	2			2		4
Sorrencia	1	2				3
Calcària		2	4	1	1	8
Ceràmica		5	20	25	7	57
Conglomerat		1	2			3
Os		3	6	2	2	13
Quars		1	6	6	2	15
RMI		4	8	12	2	26
Sílex			1	1		2
Sorrencia			2	2	1	5
Orgànic				1		1
<b>Total</b>	<b>3</b>	<b>18</b>	<b>49</b>	<b>52</b>	<b>15</b>	<b>137</b>

Fig. 30.- Planta, seccions i repartició per talles i materies del registre arqueològic de l'estructura 10.2

# ESTRUCTURA 10.3

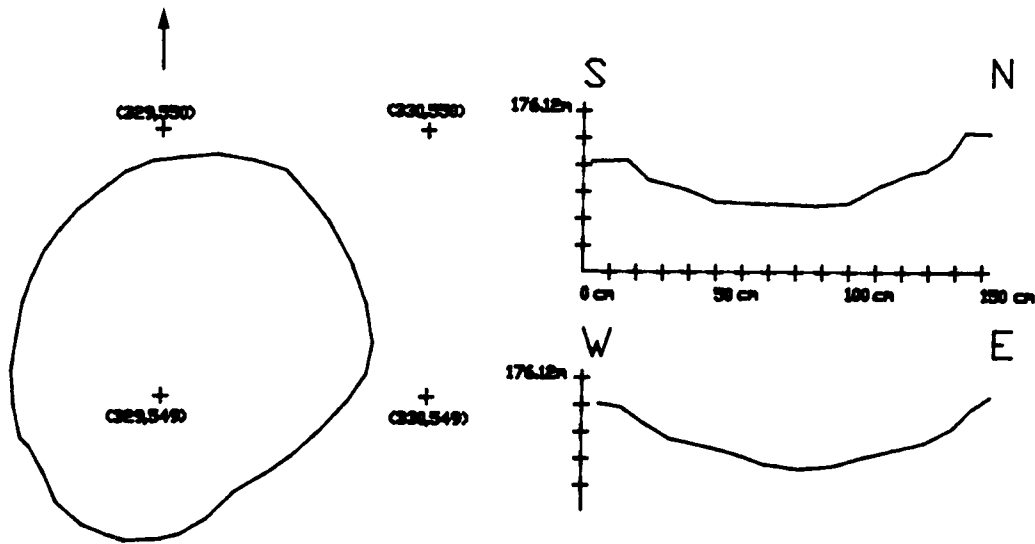

## ESTRUCTURA 10.3

Punt Zero = 177.32 m.  
Nivell a 0.50 m.

Talles	18	19	20	TOTAL
Ceràmica	12	16	21	49
Altres	1 Indet			1
Silex	1			1
Calçària			1	1
Os			1	1
RMI			3	3
<b>Total</b>	<b>14</b>	<b>16</b>	<b>26</b>	<b>56</b>

Fig. 31.- Planta, seccions i repartició per talles i materies del registre arqueològic de l'estructura 10.3.



ESTRUCTURA 10.4

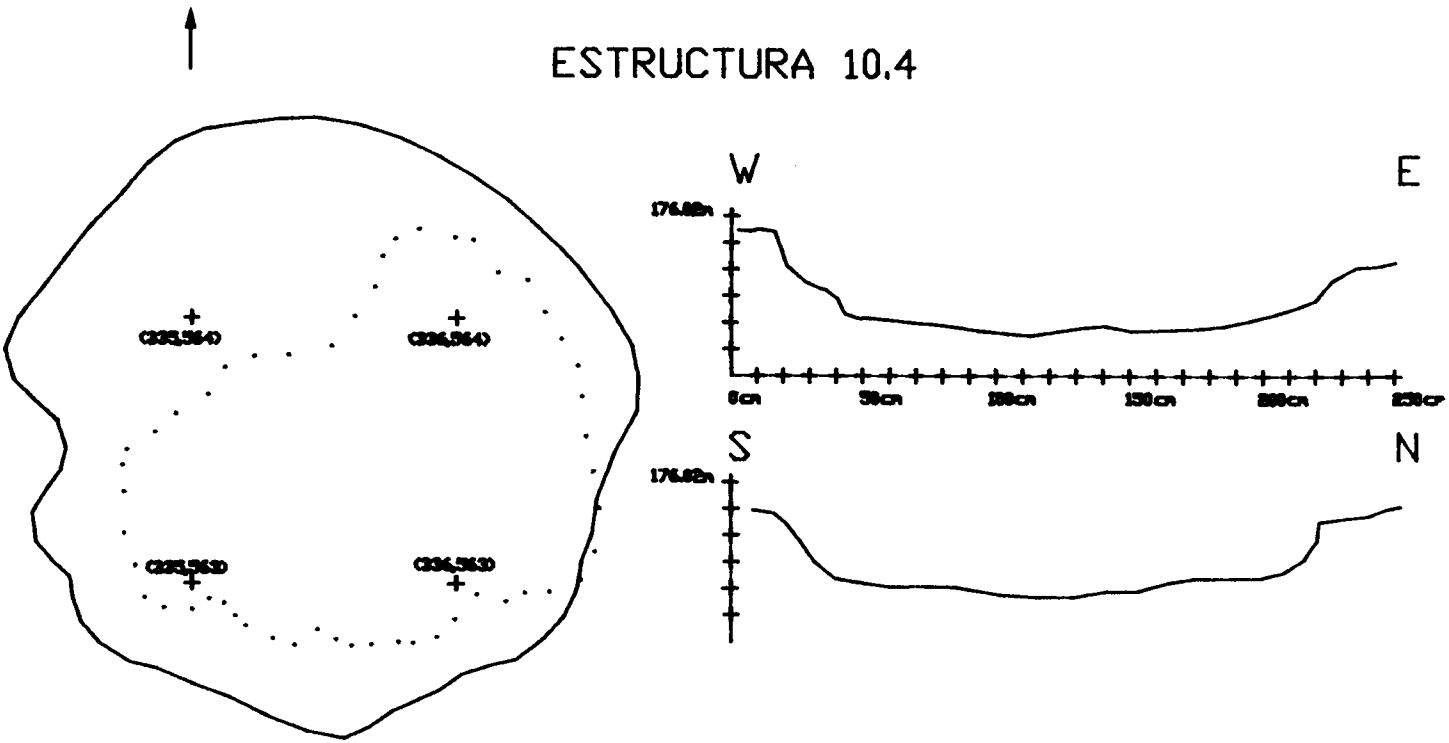

Fig. 32a. - Planta, seccions de l'estructura 10.4

## ESTRUCTURA 10.4

Punt Zero = 177.32 m.  
Nivell a 0.50 m.

Talles	14	15	16	17	18	TOTAL
Calcària	5	6	9	9	7	36
Ceràmica	40	33	54	40	12	179
Conglomerat	1	6	4	4	2	17
Altres	Esquist 3 Granit	Indet 4 Esquist Granit	1 Granit	Quarsita Indet 8 Esquist Granit	2 Granit	18
Oss	5	5	20	8	2	40
Quars	9	12	10	20	5	56
RMI	15	20	38	67	26	166
Síllex	3	6	2	1		12
Sorrencia	6	11	8	35	11	71
Tovot	8	7	6	2		23
Orgànic		1 Molusc	1 Molusc	1 Molusc		3
<b>Total</b>	<b>95</b>	<b>111</b>	<b>153</b>	<b>195</b>	<b>67</b>	<b>621</b>

Fig. 32b.- Repartició per talles i materies del registre arqueològic de l'estructura 10.4.

## ESTRUCTURA 10.5

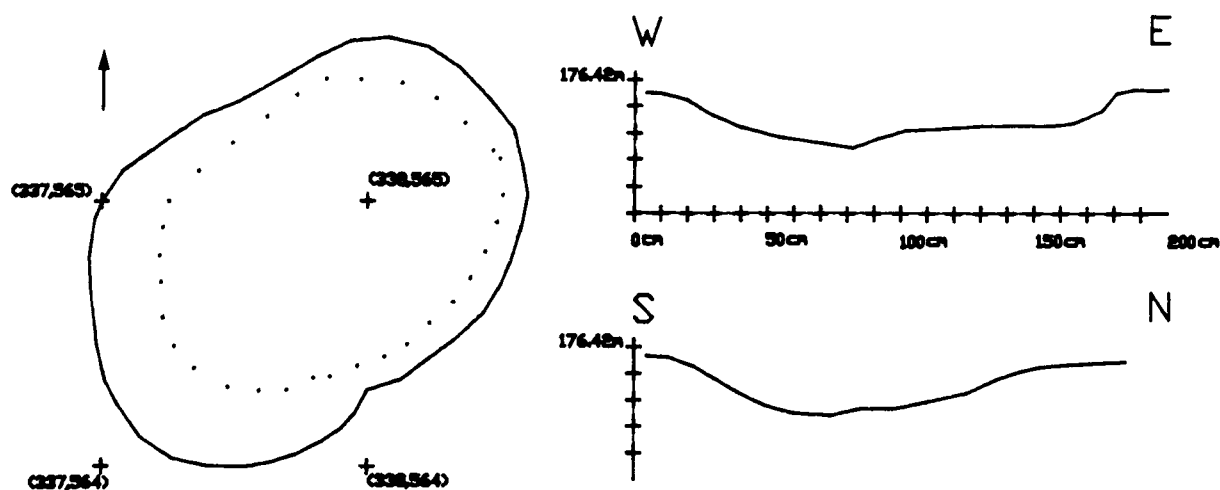

### ESTRUCTURA 10.5

Punt Zero = 177.32 m.  
Nivell a 0.50 m.

Talles	0	14	15	16	17	TOTAL
Orgànic	3		1			4
RMI	1	12	17			30
Calcària		4	2			6
Ceràmica		11	15	2		28
Conglomerat		1	5			6
Os		3	7			10
Quars		4	13			17
Sílex		4	4			8
Sorrenca			9		1	10
<b>Total</b>	<b>4</b>	<b>39</b>	<b>73</b>	<b>2</b>	<b>1</b>	<b>120</b>

Fig. 33.- Planta, seccions i repartició per talles i materies del registre arqueològic de l'estructura 10.5.

### V.3.- CARRER 11

S'han identificat dues estructures d'emmagatzematge (Fig.34):

- La 11.1 excavada a les argiles grogues amb nòduls de carbonats i la 11.5 excavada a les argiles vermelles també amb carbonats. El reompliment d'ambdúes és d'argiles fosques i material arqueològic. Totes dues es troben força arrasades, sobretot la 11.1 que només té uns 15 cms. de fondària. A part d'aquestes dues estructures hi han evidències de l'existència d'una tercera que va ser totalment destruïda per la màquina excavadora, restant en secció només algun fragment de ceràmica, fauna i pedres.

Després d'una primera revisió del material aparegut es poden situar cronològicament en el període Neolític Mig Recent (Sepulcres de Fossa). Destaca l'estructura 11.1 que presenta gran quantitat d'indústria lítica (làmines sobre sílex melat i una destal polida) i òssia (punxons, espàtules i una plaqueta perforada). La ceràmica presenta fragments amb decoració probablement Chassey.

Tipològicament es diferencien perquè la 11.1 té el fons pla, trobant-se a més molt arrasades i tallada per una rasa de conreu, mentre que la 11.5 es més profunda i té el fons en cubeta (Figs. 35 i 36).

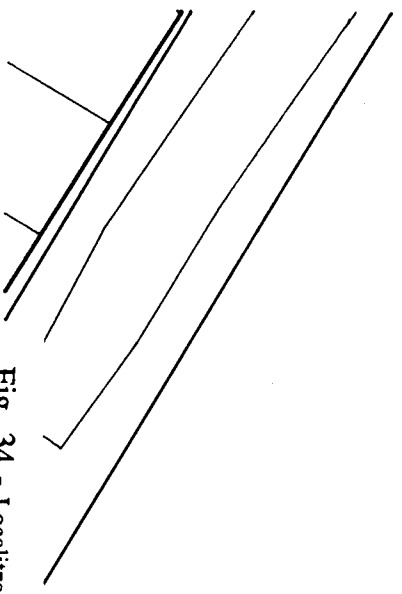
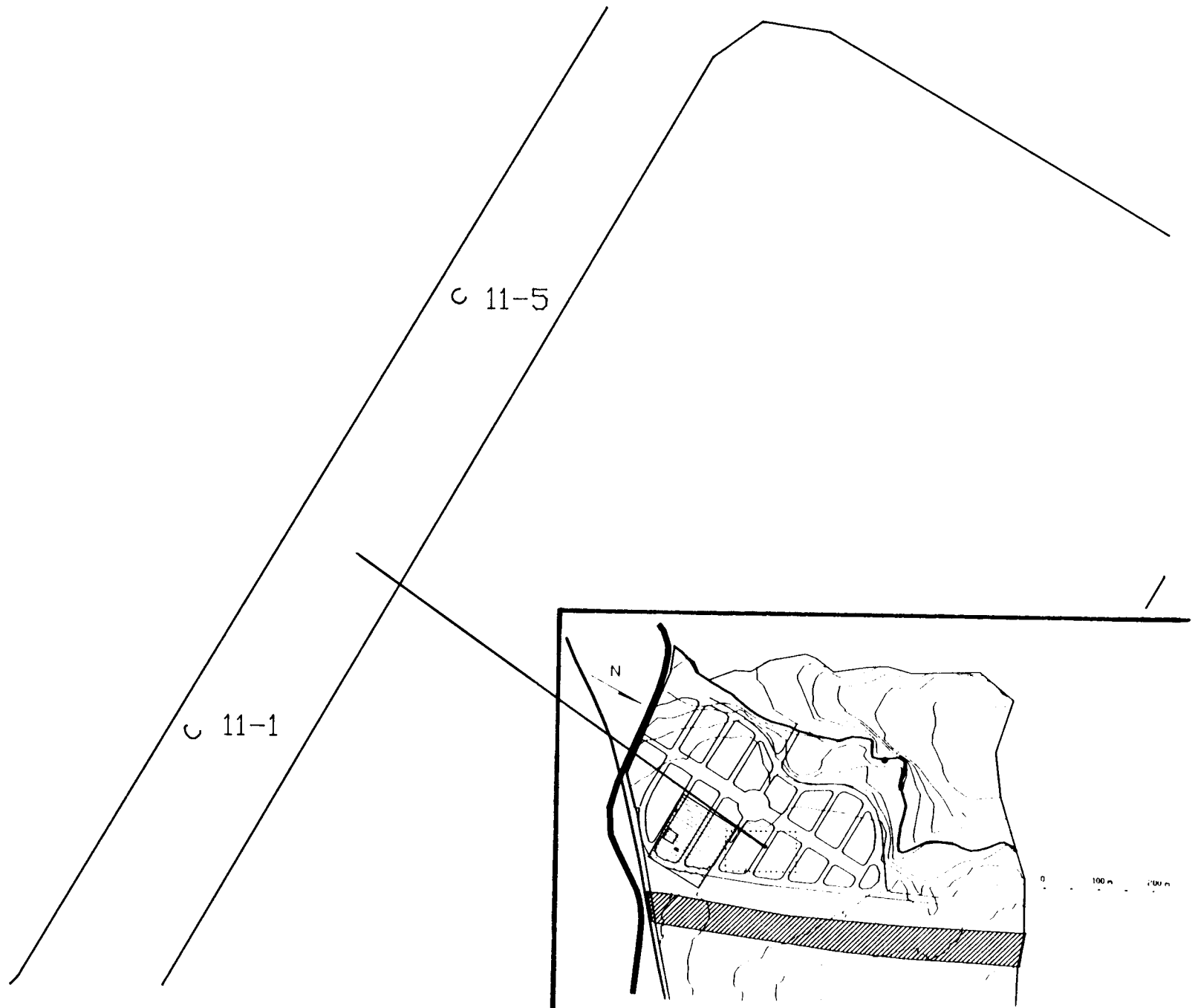
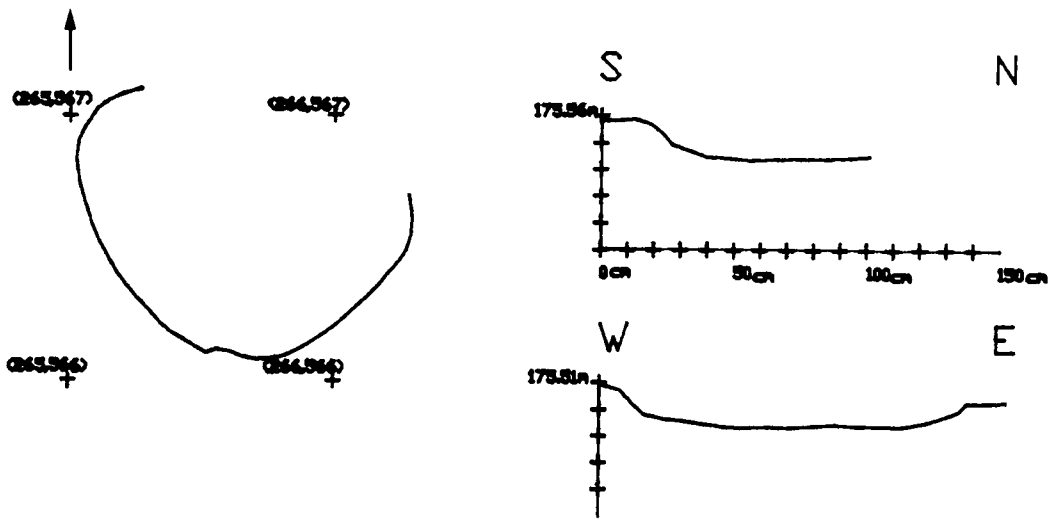

Fig. 34 - Location of the area shown in Fig. 33



# ESTRUCTURA 11-1



## ESTRUCTURA 11.1

Punt Zero = 176.31 m.  
Nivell a 0.50 m.

Talles	11	12	13	TOTAL
Calcària	1	4		5
Ceràmica	27	23	11	61
Conglomerat	3	1		4
Os	14	10	7	31
Quars	1			1
Ind. òssia	2	8	3	13
RMI	13	4	1	18
Sílex	10	3	2	15
Sorrenca	3	1		4
Altres		1		1
<b>Total</b>	<b>74</b>	<b>55</b>	<b>24</b>	<b>153</b>

Fig. 35.- Planta, seccions i repartició per talles i materies del registre arqueològic de l'estructura 11.1.

# ESTRUCTURA 11-5

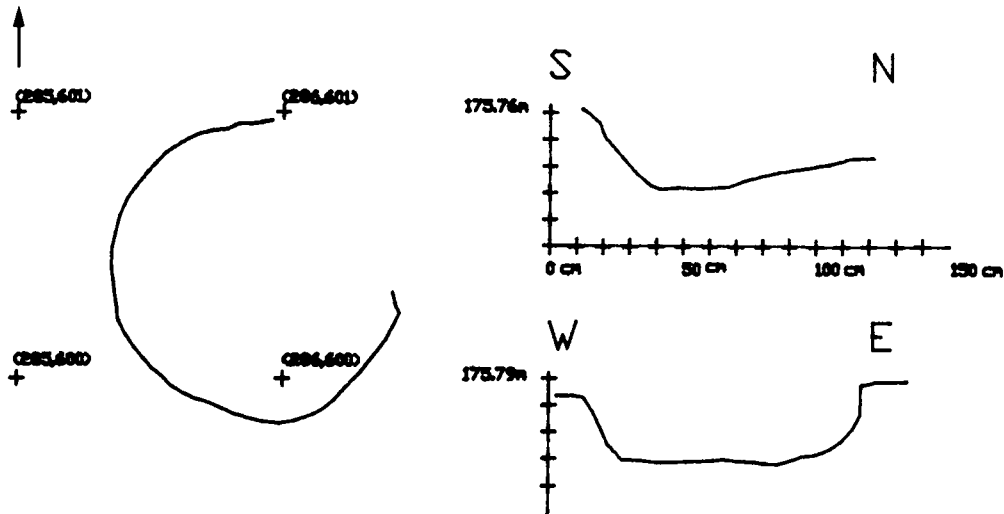

## ESTRUCTURA 11.5

Punt Zero = 176.31 m.  
Nivell a 0.50 m.

Talles	11	12	13	TOTAL
Ceràmica	12	28	2	42
Altres	6	5	4	15
Os	1	7	2	10
Quars	3	4	3	10
RMI	5	37	16	58
Calcària		1	2	3
Conglome		1	1	2
Sorrenca		3	5	8
Tovot		1		1
<b>Total</b>	<b>27</b>	<b>87</b>	<b>35</b>	<b>149</b>

Fig. 36.- Planta, seccions i repartició per talles i materies del registre arqueològic de l'estructura 11.5

#### V.4.- ILLA I

En aquesta s'han excavat set estructures de les que en només cinc casos podem parlar de fosses, (Fig. 37) és a dir d'estructures excavades en el subsòl, les altres dues són només petites concentracions de material en superfície. Les cinc fosses d'emmagatzematge es troben excavades al subsòl d'argiles grogues amb nòduls de carbonat i reomplertes d'argiles fosques i material arqueològic.

Després d'un primer repàs del material no es pot donar una atribució cronològica precisa, encara que es pot apuntar que es tracta d'estructures corresponents a Neolític Mig o Final.

Algunes de les fosses aporten material més significatiu com la I-11 amb ceràmiques amb decoracions Chassey o la I-9 amb ceràmiques amb llengüetes (Veraza). La resta d'estructures presenta diferents quantitats de ceràmiques no determinables, contenint la I-7 i la I-8 un gran nombre de pedres en el seu interior.

Pel que fa a la indústria lítica cal destacar la presència de sílex en varies estructures i de laminetes i una destrat polida a la I.6. La tipologia de les fosses presenta variacions sobretot en la seva fondària. Totes presenten planta circular i fons més o menys pla amb fondàries que oscil·len entre els 40 i 120 cms., a excepció de la I.6 que només té uns 15 cms. de potència (Figs. 38,39,40,41 i 42).



Fig. 37.- Localització de les estructures d'emmagatzematge a l'Illa I.

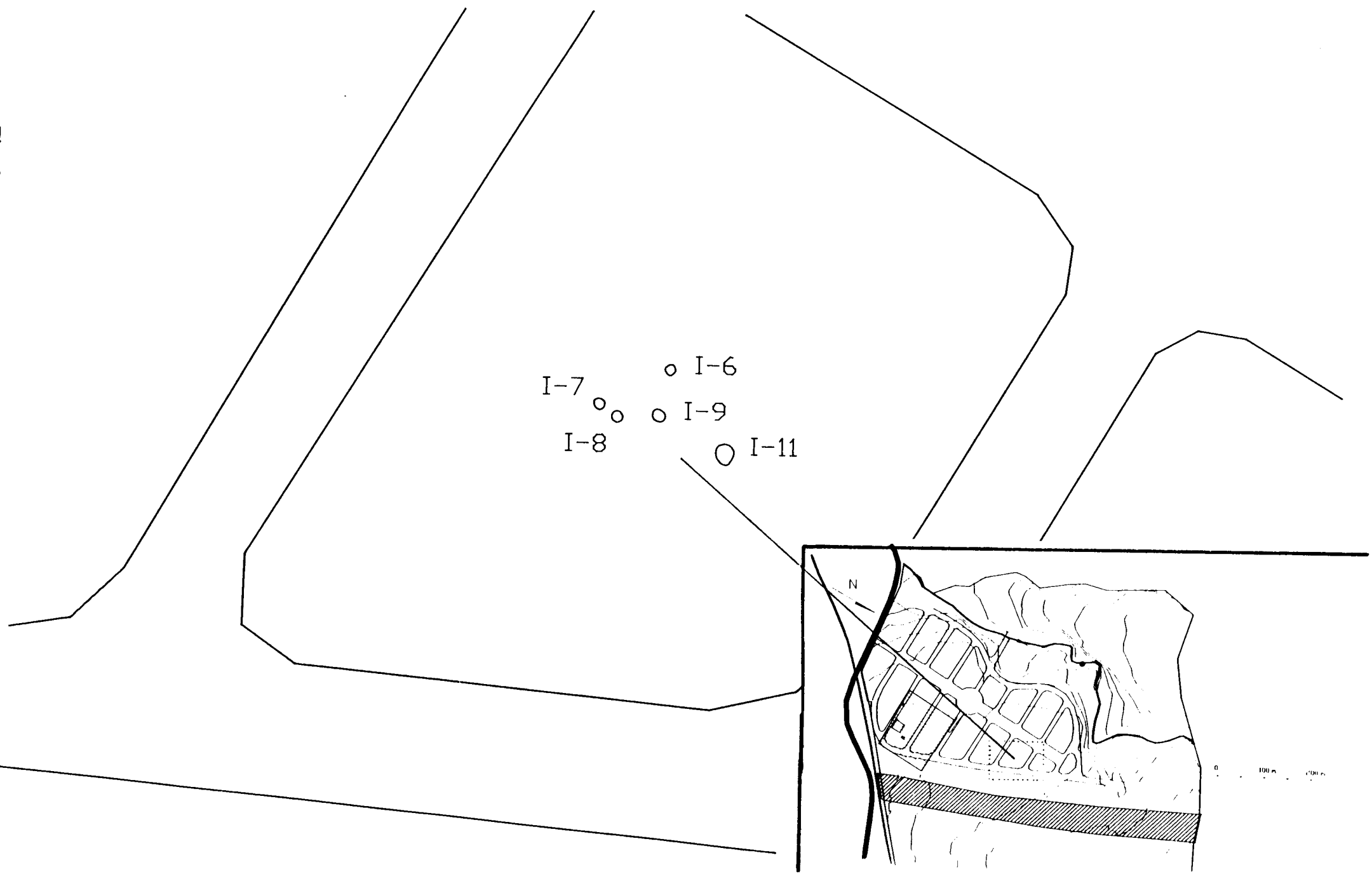

# ESTRUCTURA I-6

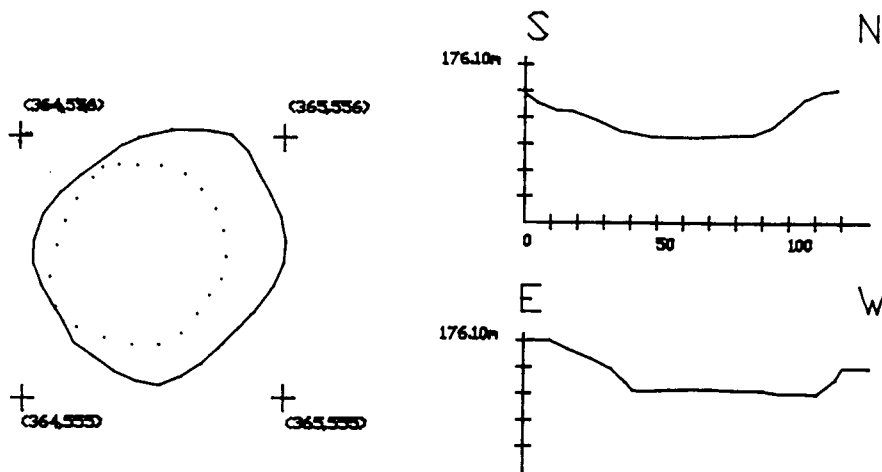

## ESTRUCTURA I.6

Punt Zero = 176,95 m.  
Nivell a 0.80 m.

Talles	9	10	11	TOTAL
Ceràmica	2	9		11
Os	2	4		6
Ind. ossia	1			1
Sílex	2	9	1	12
Calcària		1		1
Altres		1 Esquist 1 Quarsita		2
Orgànic		1 Molusc		1
RMI		1		1
<b>TOTAL</b>	<b>7</b>	<b>27</b>	<b>1</b>	<b>35</b>

Fig. 38.- Planta, seccions i repartició per talles i materies del registre arqueològic de l'estructura I.6

## ESTRUCTURA I-7

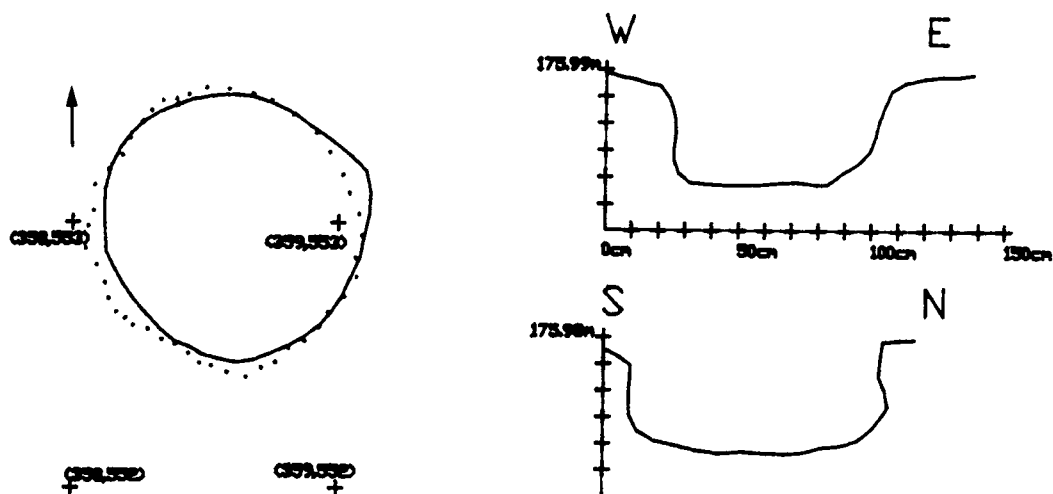

### ESTRUCTURA I.7

Punt Zero = 176.95 m.  
Nivell a 0.80 m.

Talles	6	7	8	9	10	11	12	13	TOTAL
Tovot					2	8			10
Altres	1 Granit			1 Esquist 1 Granit		1 Esquist 2 Quarsita 2 Granit	2 Esquist	1 Esquist	11
Quars		1		2	2	5		1	11
Calcària				1	4	2	11	4	22
Ind. òssia						1	1		2
Ceràmica				6	12	8	2	1	29
Conglomerat				1	3	11	8	5	28
Sílex					2		5	4	11
Os				8	13	10	3	4	38
RMI				2	8	19	20	28	77
Sorrenca				1	3	5	8	8	25
<b>Total</b>	<b>1</b>	<b>1</b>		<b>23</b>	<b>49</b>	<b>74</b>	<b>60</b>	<b>56</b>	<b>264</b>

Fig. 39.- Planta, seccions i repartició per talles i materies del registre arqueològic de l'estructura I.7

# ESTRUCTURA I-8

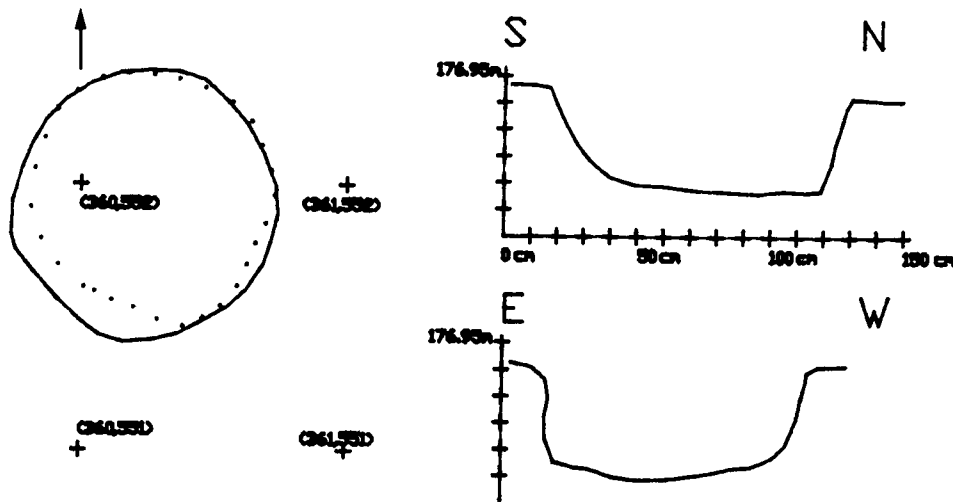

## ESTRUCTURA I.8

Punt Zero = 176.95 m.  
Nivell a 0.80 m.

Talles	10	11	12	13	TOTAL
Calcària	1	1	1		3
Ceràmica	13	12	19	19	63
Conglomerat	2	1	3	2	8
Altres	1 Granit 2 Quarsita	3 Granit 1 Quarsita	2 Granit		9
Os	3	3	3	4	13
RMI	4	14	9	2	29
Síllex	1	2	1		4
Sorrenca	3	1	1		5
Quars		1	1	1	3
Total	30	39	40	28	137

Fig. 40.- Planta, seccions i repartició per talles i materies del registre arqueològic de l'estructura I.8

# ESTRUCTURA I-9

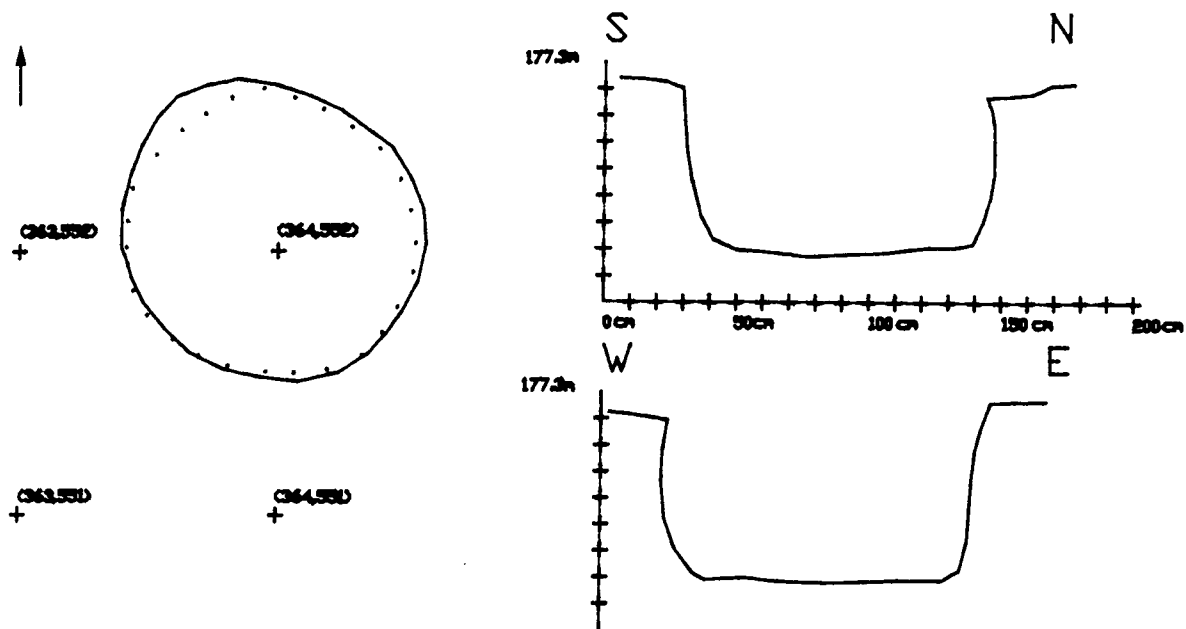

## ESTRUCTURA I.9

Punt Zero = 176.95 m.  
Nivell a 0.80 m.

Talles	9	10	11	12	13	14	15	TOTAL
Ceràmica	12	15	13	10	5	44	94	193
Conglomerat	1		1			1	3	6
Os	2	5	5	7	3	14	20	56
Síllex	1		5	1		7	8	22
Sorrencia	1						4	5
Altres		1 Esquist	2 Esquist 2 Quarsita			2 Quarsita	1 Granit 1 Quarsita	9
Orgànic							1 Molusc	1
Quars		2		2		3	1	8
RMI		4	2	4	1	6	6	23
Sorrencia		4	1			1		6
Calcària				1	1		2	4
Total	17	31	31	25	10	78	141	333

Fig. 41.- Planta, seccions i repartició per talles i materies del registre arqueològic de l'estructura I.9

# ESTRUCTURA I-11

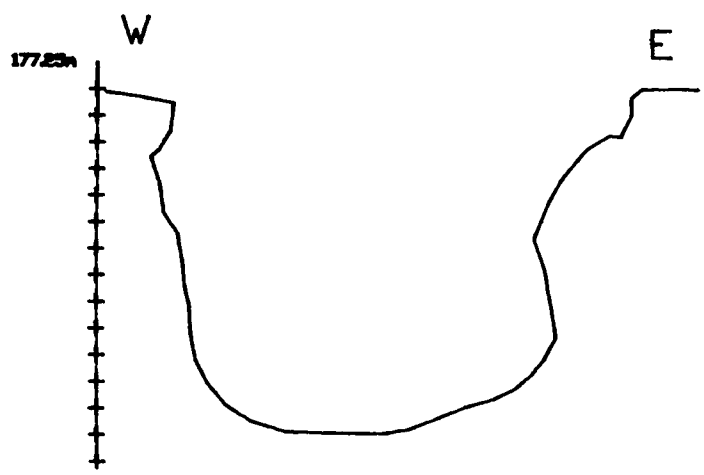
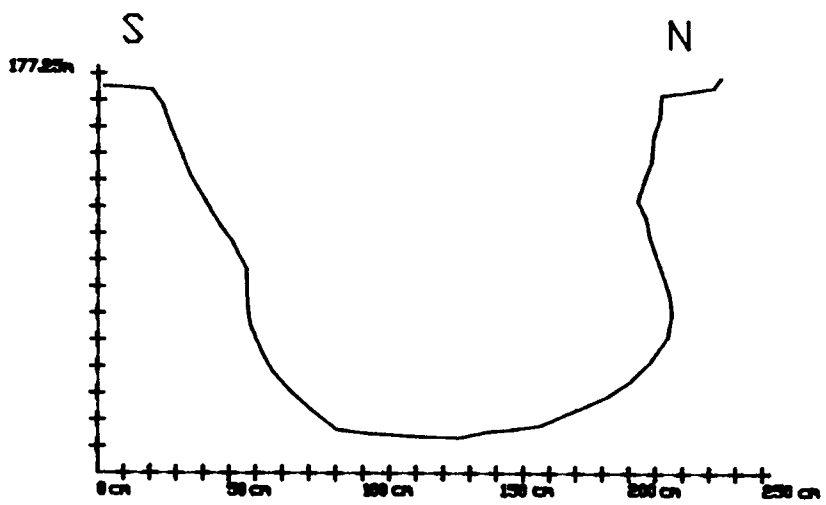
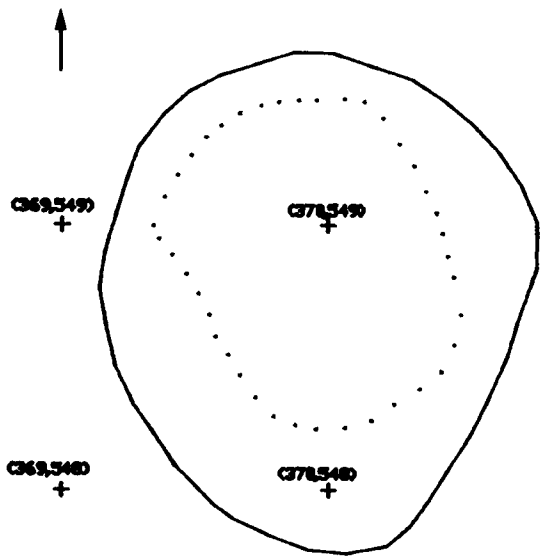

Fig. 42a. - Planta i seccions de l'estructura I.11

ESTRUCTURA I.11

Punt Zero = 176.95 m.  
Nivell a 0.80 m.

Talles	6	7	8	9	10	11	12	13	14	15	16	17	18	TOTAL
Calcària	5	5	1		3	1						1		16
Ceràmica	26	52	24	10	11	12	1	5	5	5	2	5		158
Conglomerat	10	6	4										1	21
Altres	1 Esquist 9 Indet 1 Quarsita	1 Esquist 2 Granit 4 Indet 1 Quarsita	2 Esquist	1 Indet	1 Granit 1 Indet	1 Quarsita						1 Indet		26
Quars	18	13	2	5	5	3				2				48
RMI	39	34	7	7	3	2	1			3	1	1		98
Sílex	4	1	2	1		1								9
Sorrenca	13	17	6	3		2				1	1			43
Tovot	1	5	2											8
Os		3	1		10	1	1	3	1	6		3	2	31
Ocre				1										1
Orgànic					1 Molusc									1
<b>Total</b>	<b>127</b>	<b>144</b>	<b>51</b>	<b>28</b>	<b>35</b>	<b>23</b>	<b>3</b>	<b>8</b>	<b>6</b>	<b>17</b>	<b>4</b>	<b>11</b>	<b>3</b>	<b>460</b>

Fig. 42b.- Repartició per talles i materies del registre arqueològic de l'estructura I.11

## V.5.- ILLA M

Aquesta zona del jaciment -caracteritzada per ésser la que presenta una major concentració de sepultures de les zones excavades fins ara- s'han trobat sis estructures d'emmagatzematge excavades (Fig. 43), en el subsòl d'argiles vermelles amb nòduls de carbonats i reomplertes d'argiles fosques amb material arqueològic o de terra més negra i textura més granulosa sense material arqueològic.

Després d'una revisió del material es fa difícil donar una atribució cronològica precisa en tots els casos per falta de material determinable en algunes estructures o per la falta total de material arqueològic en d'altres. Només les estructures M.3 i M.4 presenten material determinable. La primera aporta ceràmica corresponent a grans vasos de superfícies exteriors pentinades que podria correspondre al període Neolític Mig Recent (Sepulcres de Fossa), mentre que la M.4 conté ceràmica amb decoració d'arcs verticals en disposició horitzontal que podrien correspondre a l'Edat del Bronze Antic. A la M.17 ha aparegut algun fragment d'època moderna. La M.18, fossa de dimensions petites (72 cms. de diàmetre màxim) presentava les restes d'un crani d'ovicàprid que conservava encara part de les banyes, algunes làmines de sílex i fragments de ceràmica.

Tipològicament trobem força variacions. Les plantes inicials són circulars o ovalades, a excepció de la M.13 que era quadrada. Pel que fa a les bases, són planes menys la M.18 que té forma cònica. En general les trobem força arrasades conservant una potència aproximada de 20 cms., exceptuant la M.13 i M.17 que tenen entre 60 i 70 cms. de fondària (Figs. 44,45,46,47,48 i 49).



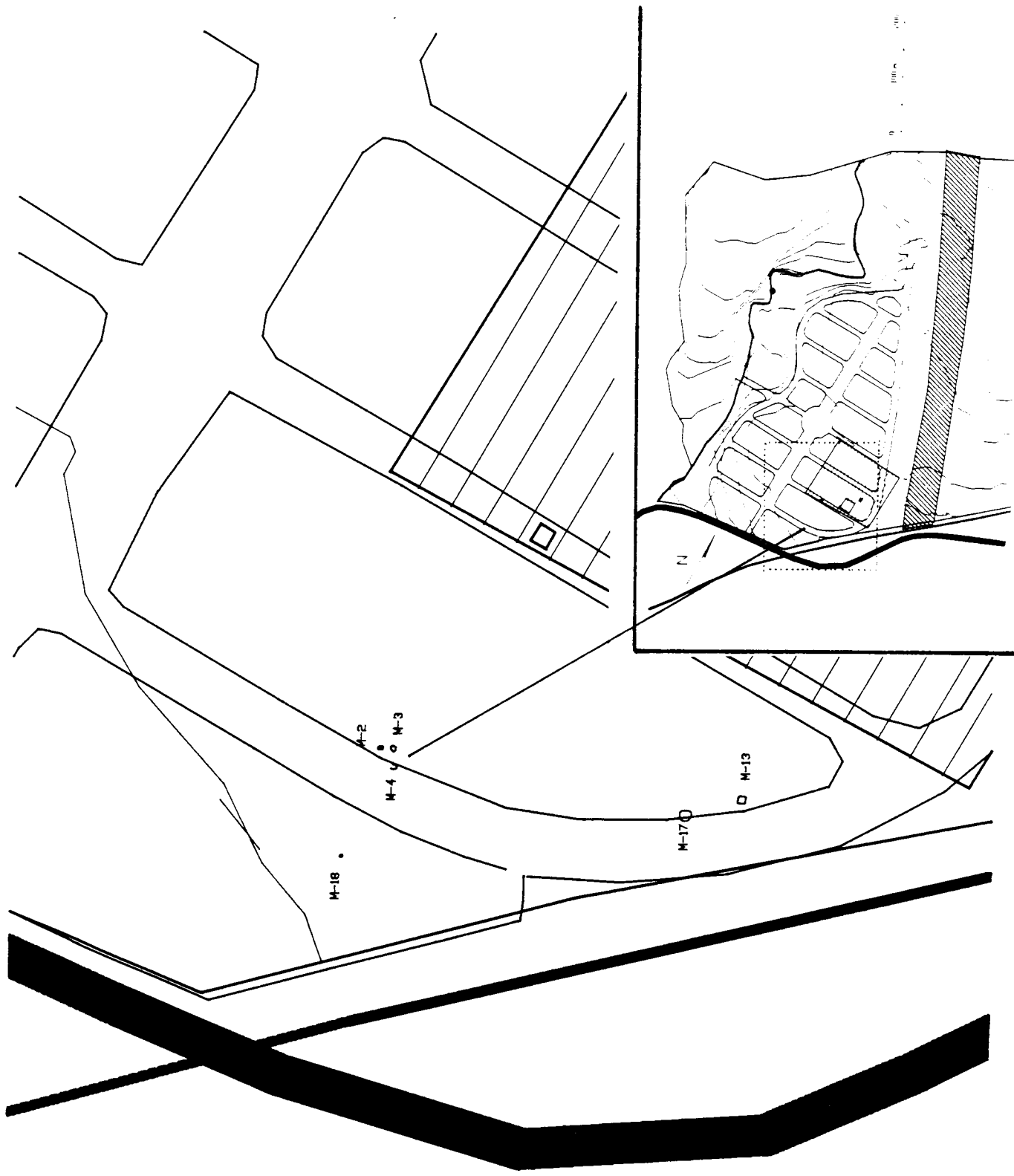
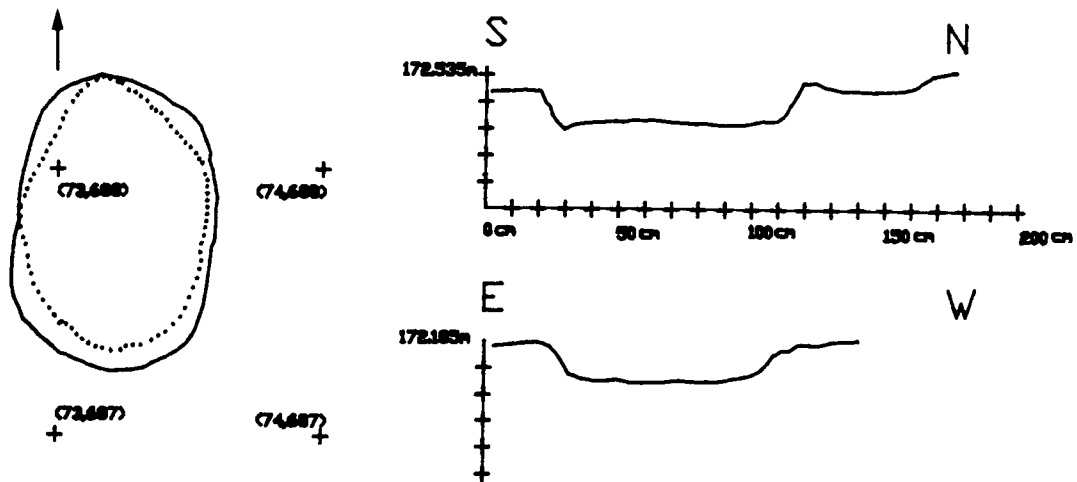

Fig. 43.- Localització de les estructures d'emmagatzematge a l'illa M.

# ESTRUCTURA M-2



## ESTRUCTURA M.2

Punt Zero = 173.27 m.  
Nivell a 1 m.

Talles	19	TOTAL
Conglomerat	1	1
Quars	1	1
RMI	1	1
Sorrenca	3	3
<b>Total</b>	<b>6</b>	<b>6</b>

Fig. 44.- Planta, seccions i repartició per talles i materies del registre arqueològic de l'estructura M.2

# ESTRUCTURA M-3

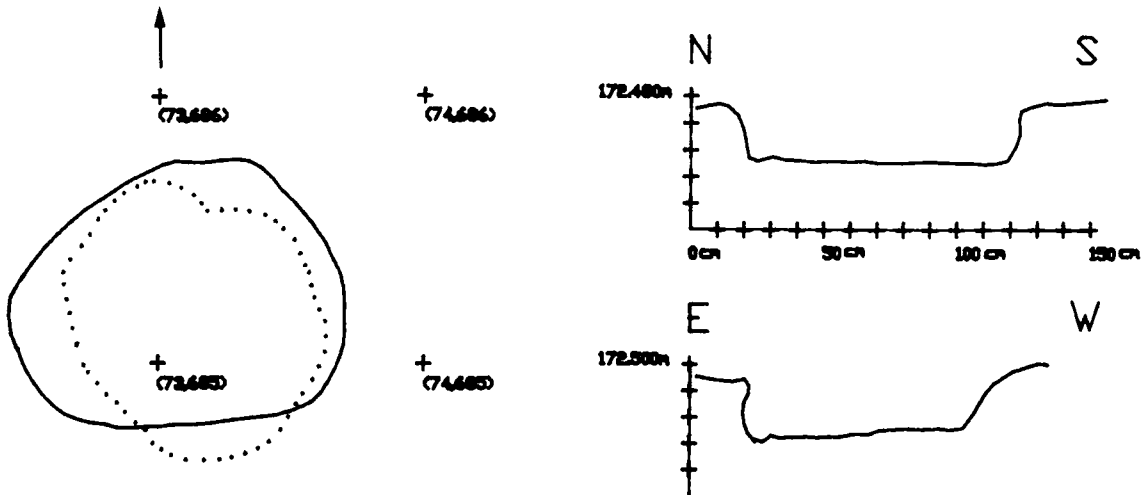

## ESTRUCTURA M.3

Punt Zero = 173.27 m.  
Nivell a 1 m.

Talles	18	19	20	TOTAL
Ceràmica	4	2	1	7
Altres	1	1		2
RMI	8	4		12
Sorrenca		2		3
<b>Total</b>	<b>13</b>	<b>9</b>	<b>1</b>	<b>23</b>

Fig. 45.- Planta, seccions i repartició per talles i materies del registre arqueològic de l'estructura M.3

# ESTRUCTURA M-4

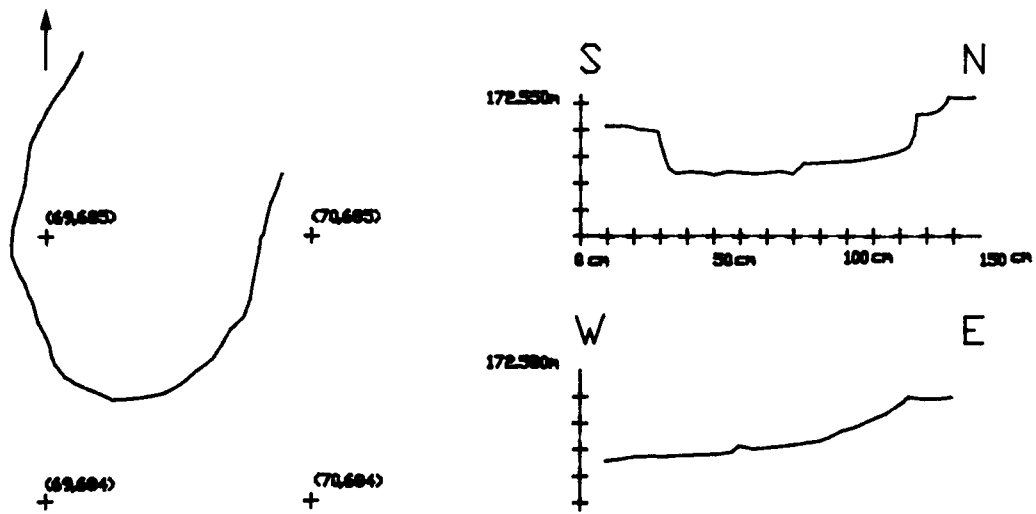

## ESTRUCTURA M.4

Punt Zero = 173.27 m.  
Nivell a 1 m.

Talles	19	20	TOTAL
Ceràmica	2	3	5
Conglomerat	2		2
Altres	2		2
Os	6	1	7
Quars	1	1	2
RMI	3	2	5
Sorrenca	2	1	3
Total	18	8	26

Fig. 46.- Planta, seccions i repartició per talles i materies del registre arqueològic de l'estructura M.4.

# ESTRUCTURA M-13

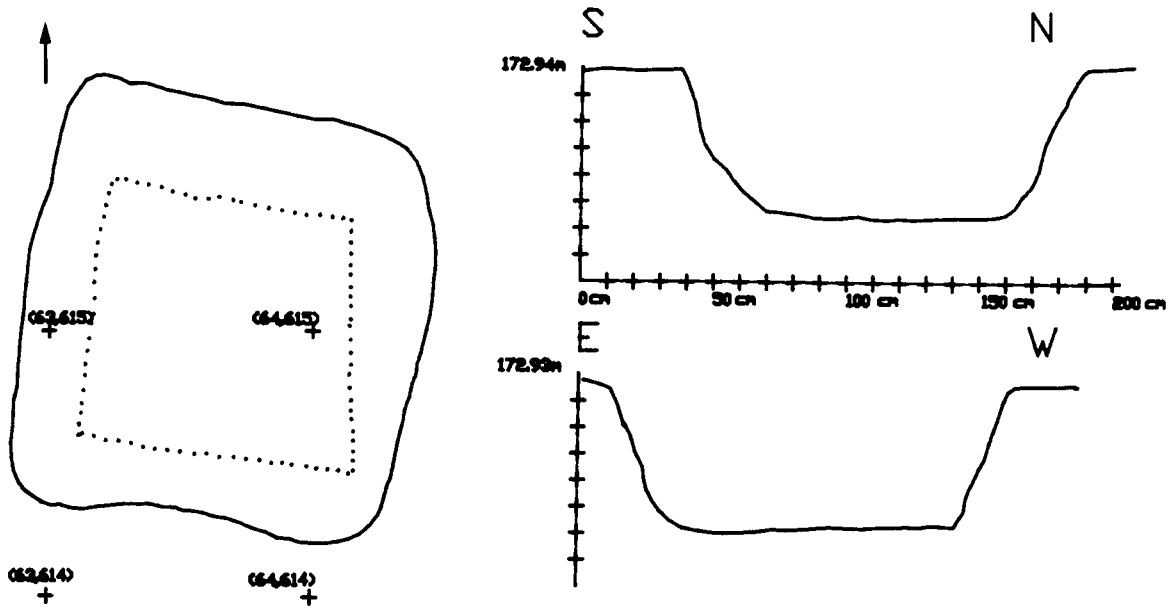

## ESTRUCTURA M.13

Punt Zero = 173.27 m.  
Nivell a 1 m.

Talles	14	15	TOTAL
Ceràmica	2	2	4
Os		1	1
Total	2	3	5

Fig. 47.- Planta, seccions i repartició per talles i materies del registre arqueològic de l'estructura M.13

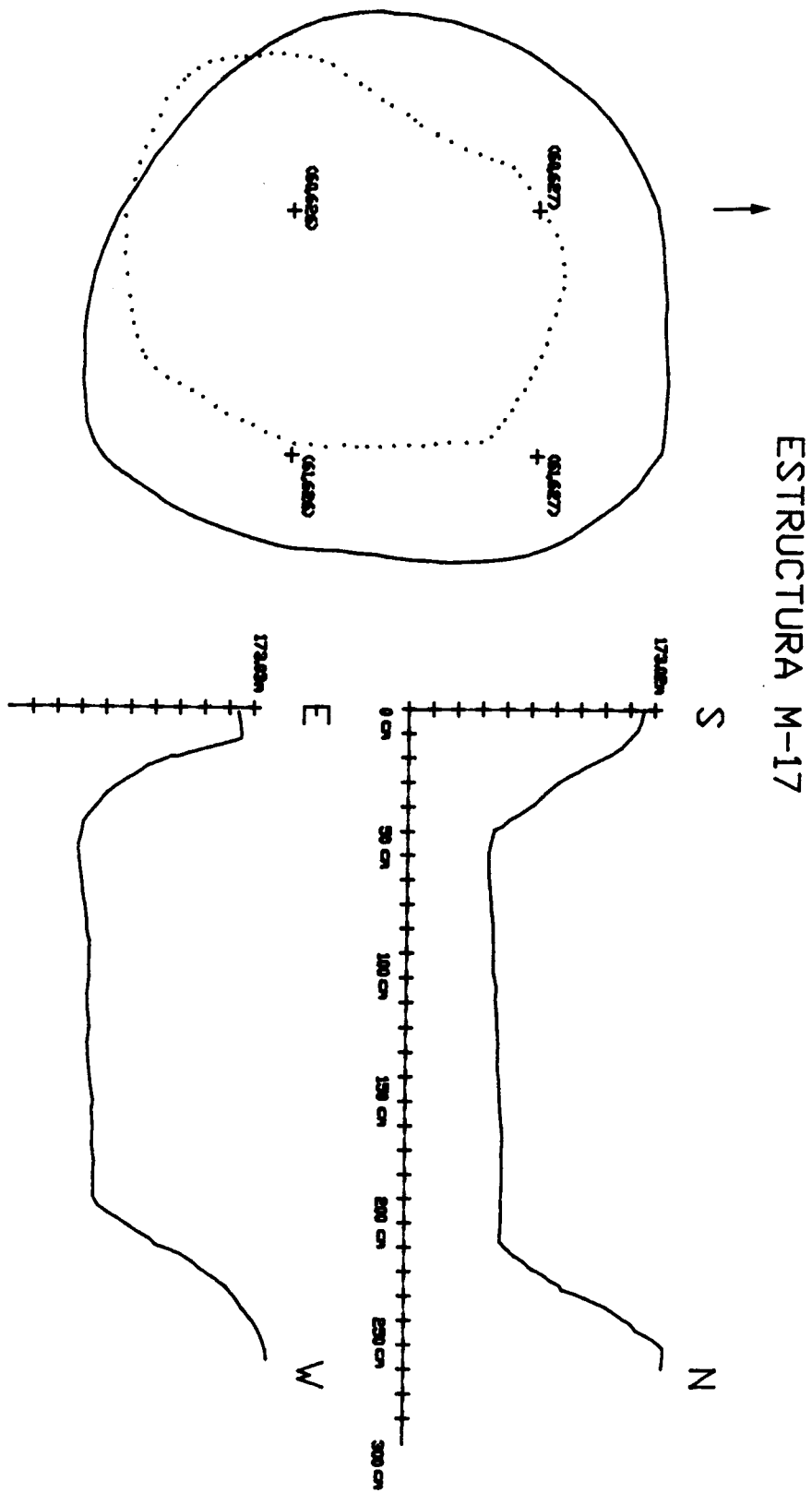
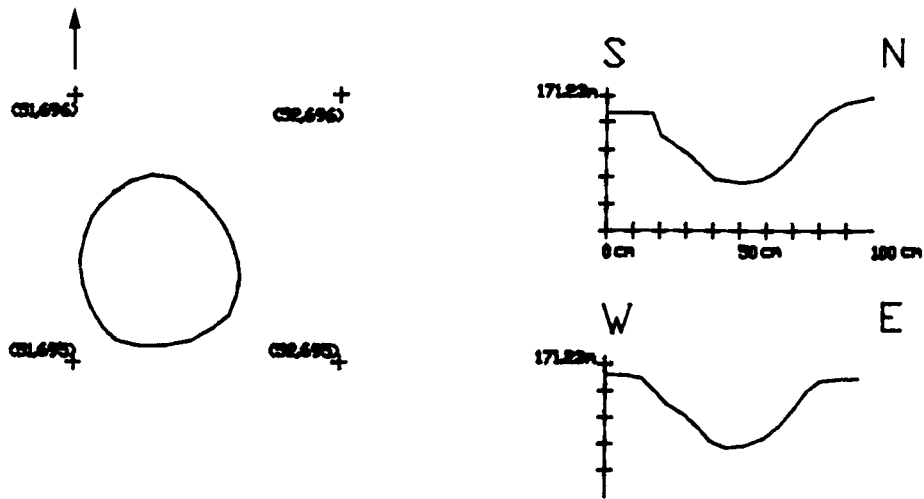

Fig. 48.- Planta, seccions de l'estructura M.17

# ESTRUCTURA M-18



## ESTRUCTURA M.18

Punt Zero = 173.27 m.  
Nivell a 1 m.

Talles	32	33	TOTAL
Os	1		1
Silix	2		2
Sorrenca		1	1
Total	3	1	4

Fig. 49.- Planta, seccions i repartició per talles i materies del registre arqueològic de l'estructura M.18

## **VI.- ENTERRAMENTS**

En aquest apartat descriurem les fosses sepulcral i els individus que s'han trobat seguint el mateix esquema que el de les estructures d'emmagatzematge, és a dir, separant-les per les zones on s'han localitzat, carrers i illes.

En relació a la seva cronologia tots els enterraments documentats s'enquadren en el Neolític Mig Recent ( Grup de Sepulcres de Fosses)

### **VI.1.- CARRER 7**

En aquest carrer només es va trobar una sepultura, la 7.7 (Fig. 50).

#### **VI.1.1.- 7-7**

Té forma circular i està excavada en el paquet d'argiles vermelles amb carbonats, les parets baixaven verticalment arribant a la base plana. La tipologia de la tomba és de cambra i pou amb una llosa vertical barrant l'accés. La llosa, de conglomerat, es trobava falcada per pedres més petites.



Fig. 50 - Iocalización de Pantanillo de agua.

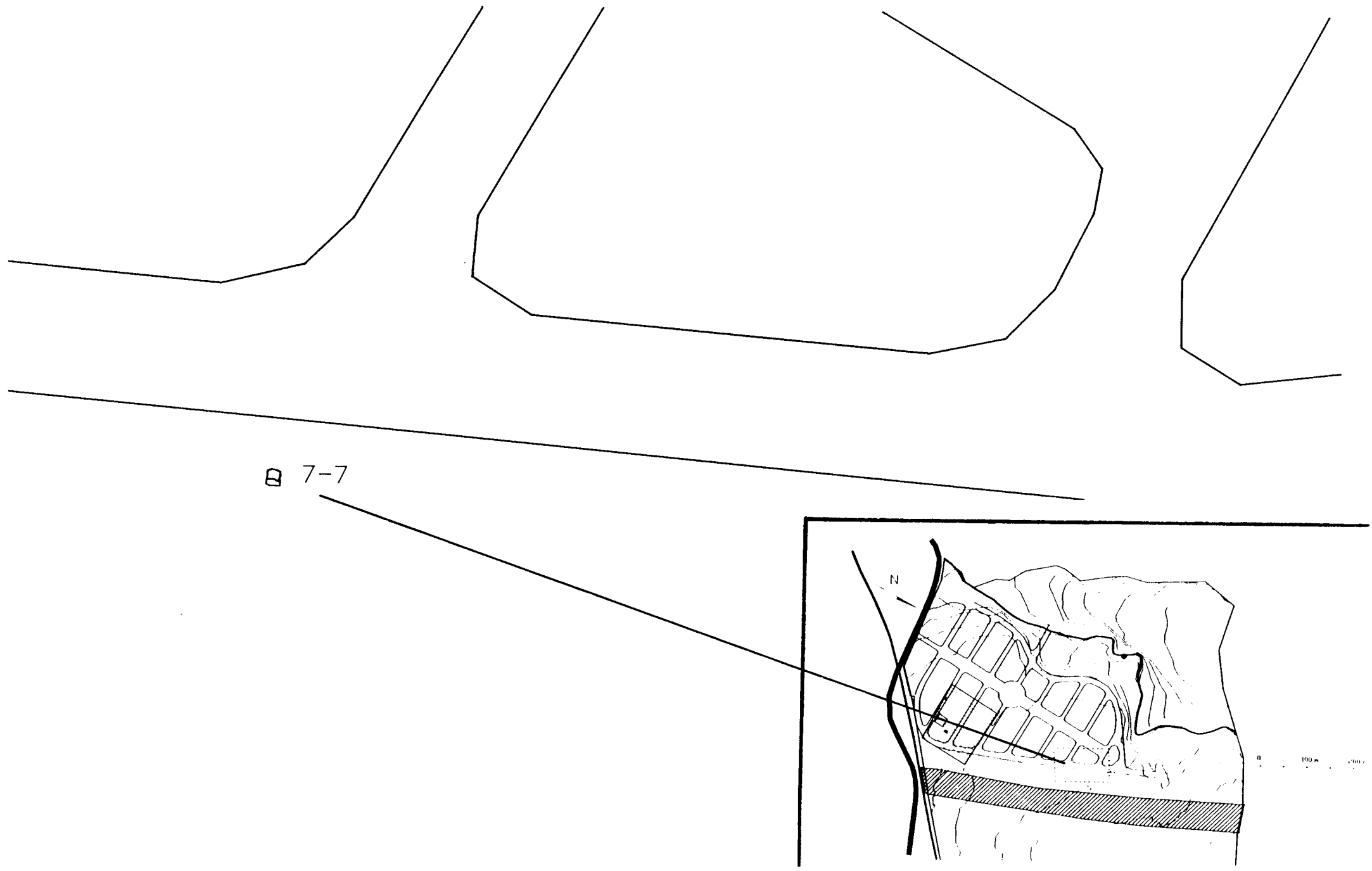

El mort estava orientat N-S i l'accés a la sepultura era per l'E i el pendent cap a l'W. L'individu reposava directament contra el tortorà i només hi havia una petita pedra, sense cap funció evident, col·locada a l'esquerra de l'inhumat. L'esquelet havia estat dipositat sobre l'esquena amb el cap basculat o recolzat expressament contra o sobre l'espatlla dreta, quedant el maxilar i la mandíbula contra l'escàpula i totalment inclinat. Les vertebres cervicals estaven lateralitzades cap a la dreta (cap a l'Est), seguint el basculament del cap.

Les extremitats anteriors havien esta col·locades en angle quasi recte amb els braços (cúbit i radi) sobre l'abdòmen. No es conservaven pràcticament els ossos de les mans. La pelvis es presentava oberta i les extremitats inferiors havien basculat cap a l'Est, recolzades contra la paret de la cambra. Les extremitats inferiors estaven totalment plegades i amb els peus en posició funcional, és a dir, amb la planta cap el terra. La cama esquerra s'havia introduït un xic dintre de la dreta, en el moment de bascular contra la paret.

Pel que fa a l'aixovar que l'acompanyava hi havia: dues làmines i una punta de fletxa sobre sílex i dos punxons sobre os (Figs. 51 i 52).

ESTRUCTURA 7.7

Punt Zero = 185.21 m.  
Nivell a 1.80 m.

	BP	BN2G	BNA	TOTAL
Sílex	2	1		3
Quars			1	1
Os		2		2
<b>Total</b>	<b>2</b>	<b>3</b>	<b>1</b>	<b>6</b>

Fig. 51.- Planta de l'enterrament 7.7

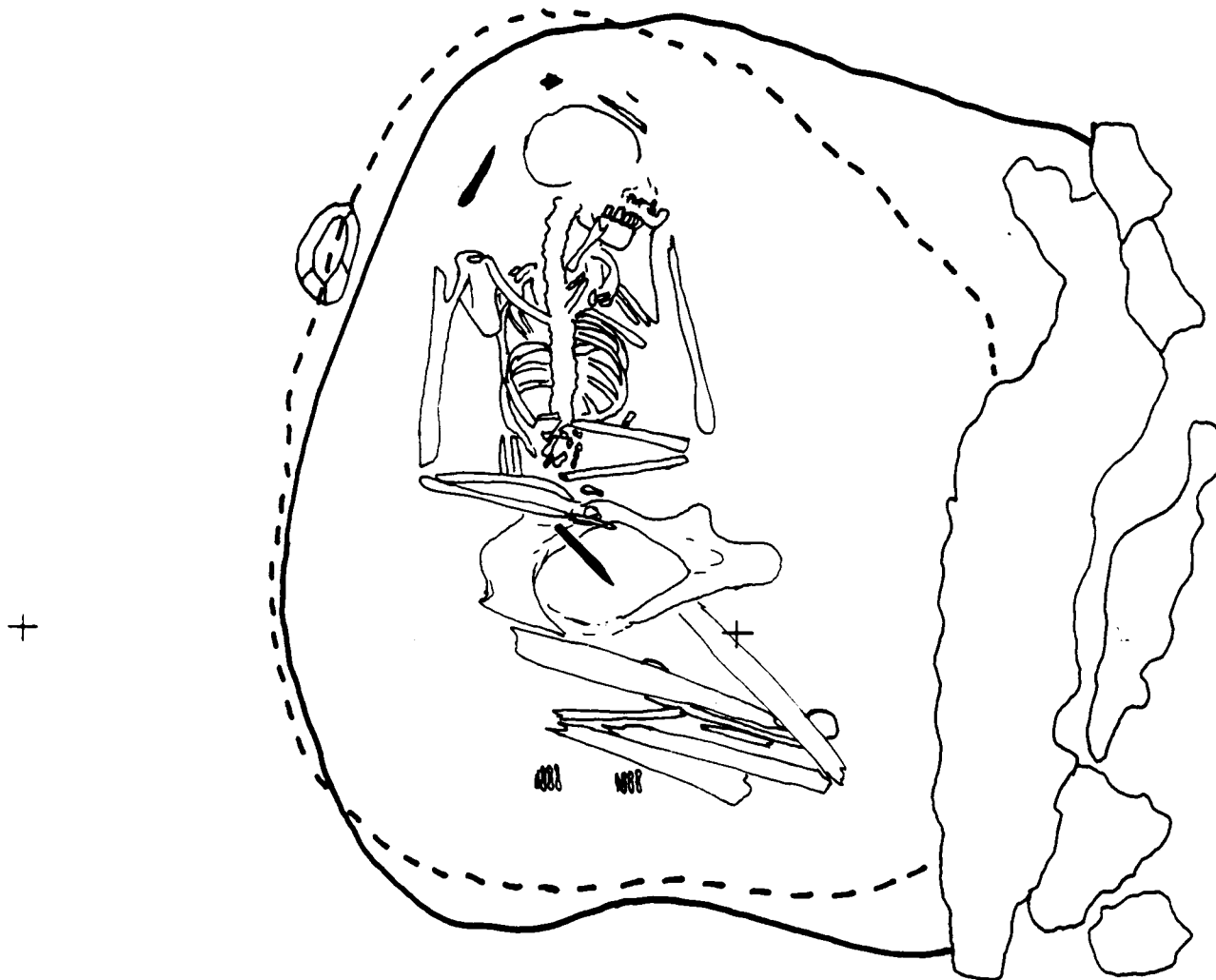

Planta inicial ———

Planta final - - - - -

■ Indústria lítica

■ Ceràmica

■ Indústria òssia

■ Objectes d'ornament

N  
↑

0  
—————

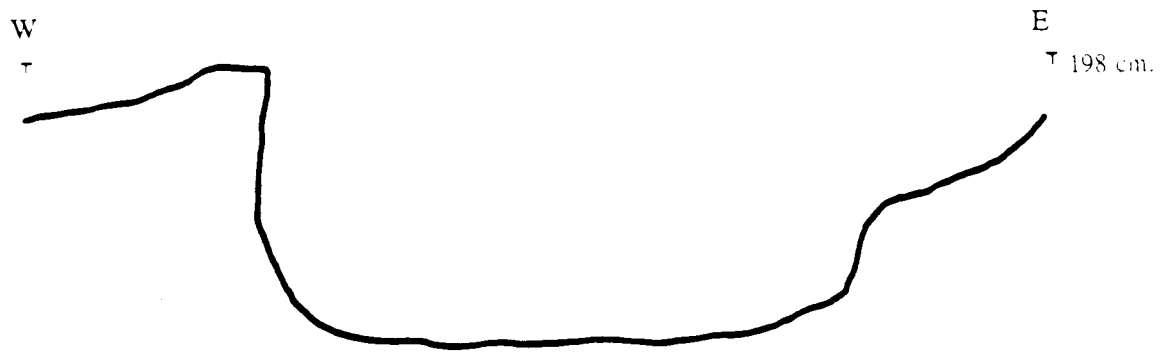

0 50 cm.

A horizontal scale bar with alternating black and white segments, representing a length of 50 centimeters.

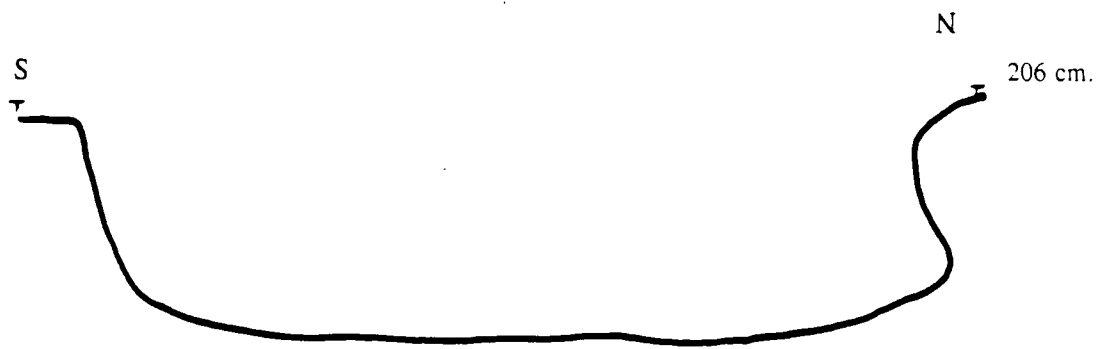

0 50 cm.

A horizontal scale bar with alternating black and white segments, representing a length of 50 centimeters.

Fig. 52.- Seccions N/S i E/W de l'enterrament 7.7

## VI.2.- CARRER 11

En aquest carrer s'hi van excavar tres sepultures (Fig. 53)

### VI.2.1.- 11-2

Fossa tallada per la màquina, quedant escapçada parcialment pel sud. Tindria una forma circular, no gaire profunda (aprox. 30 cms.). A l'interior es localitzen les restes òssies d'un individu jove recolzat sobre el costat dret que només presentava el tronc i els braços. Al voltant del mort hi trobem tot un seguit de pedres disposades acuradament formant quasi un enllosat.

La falta d'espai que ens fa intuir l'existència de la pelvis i extremitats inferior així com l'absència de fragments ossis ens porta a creure que aquest fet fos intencionat.

Pel que fa al crani estava també de costa i ben col·locat però no estava en connexió amb les vèrtebres. Les costelles totes en connexió i ben conservades, excepte les del costat esquerre, possiblement malmeses al no trobar-se en contacte amb el terra. El braç dret estava flexionat i en connexió conservant algunes falanges de la mà i en posició anatòmica primària. En canvi, del braç esquerre, només quedava l'húmer.

L'orientació del mort és NE/SW.

D'aixovar s'hi van trobar ceràmiques pràcticament senceres i una petita destrat (Figs. 54 i 55).

Fig. 53. - Localització dels enterraments al carrer 11.

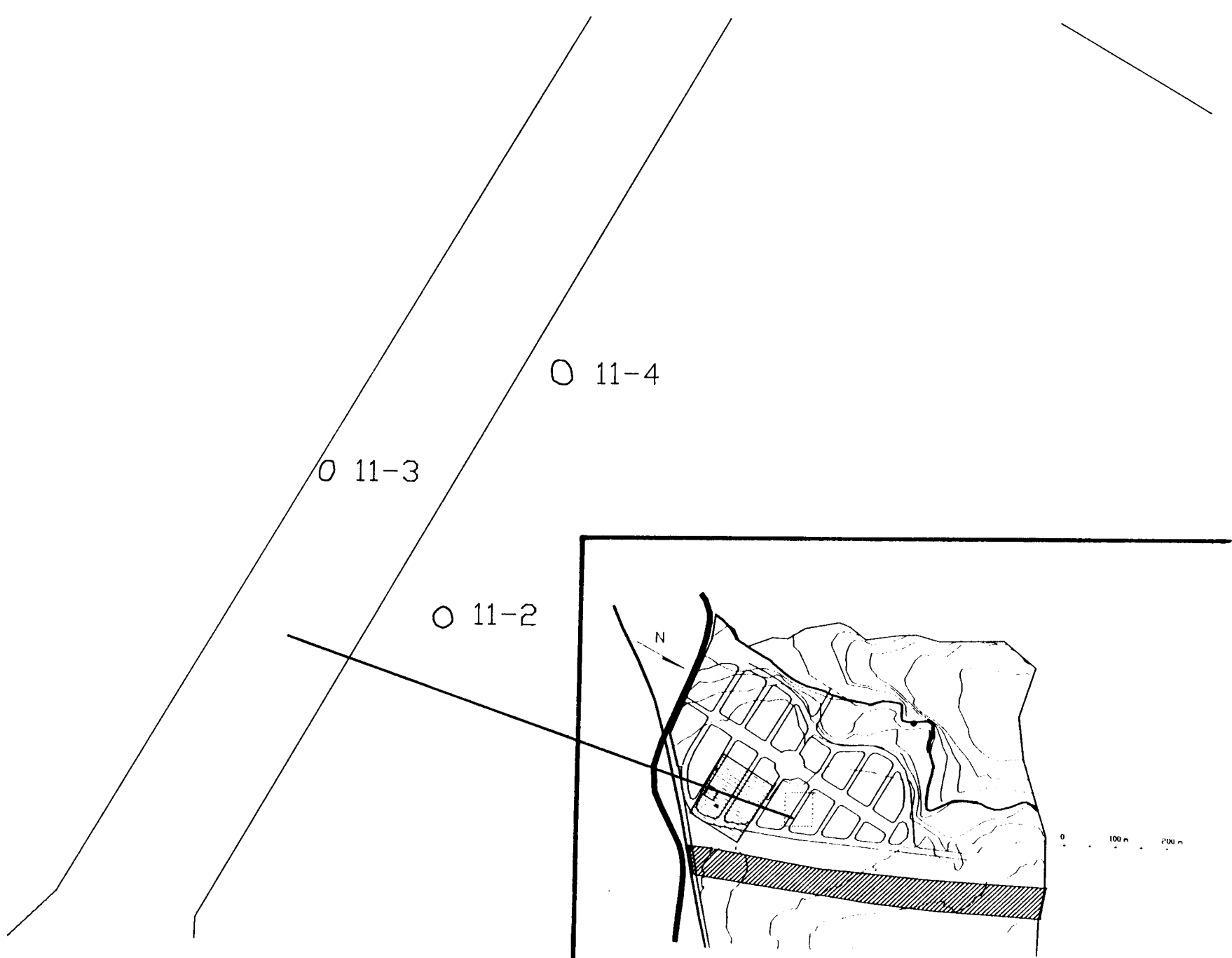
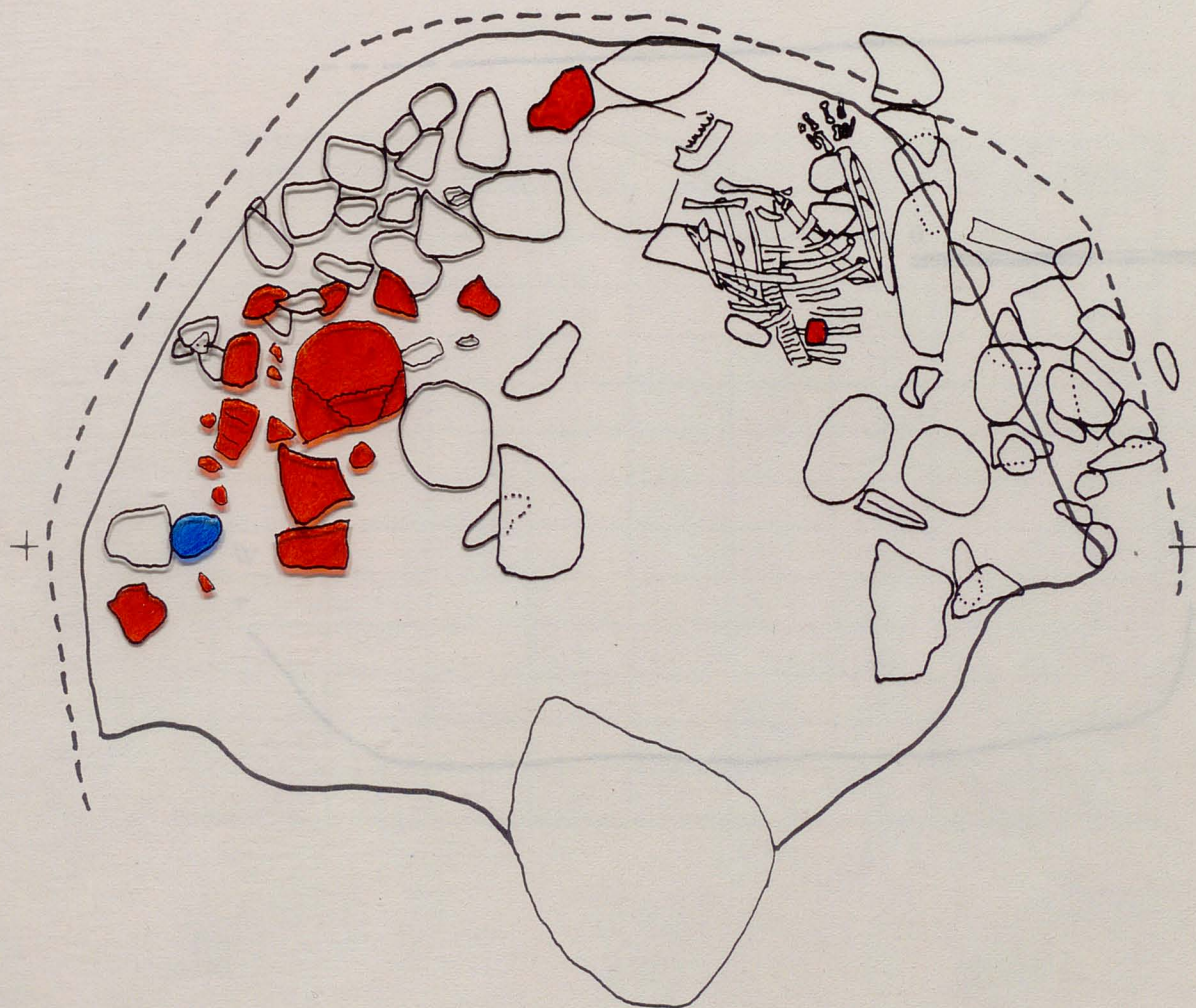



Fig. 54.- Planta de l'enterrament 11.2



Planta inicial ———

Planta final - - - - -

 Indústria lítica

 Indústria òssia

 Ceràmica

 Objectes d'ornament

N  
↑

0 50





Fig. 55.- Seccions N/S i E/W de l'enterrament 11.2



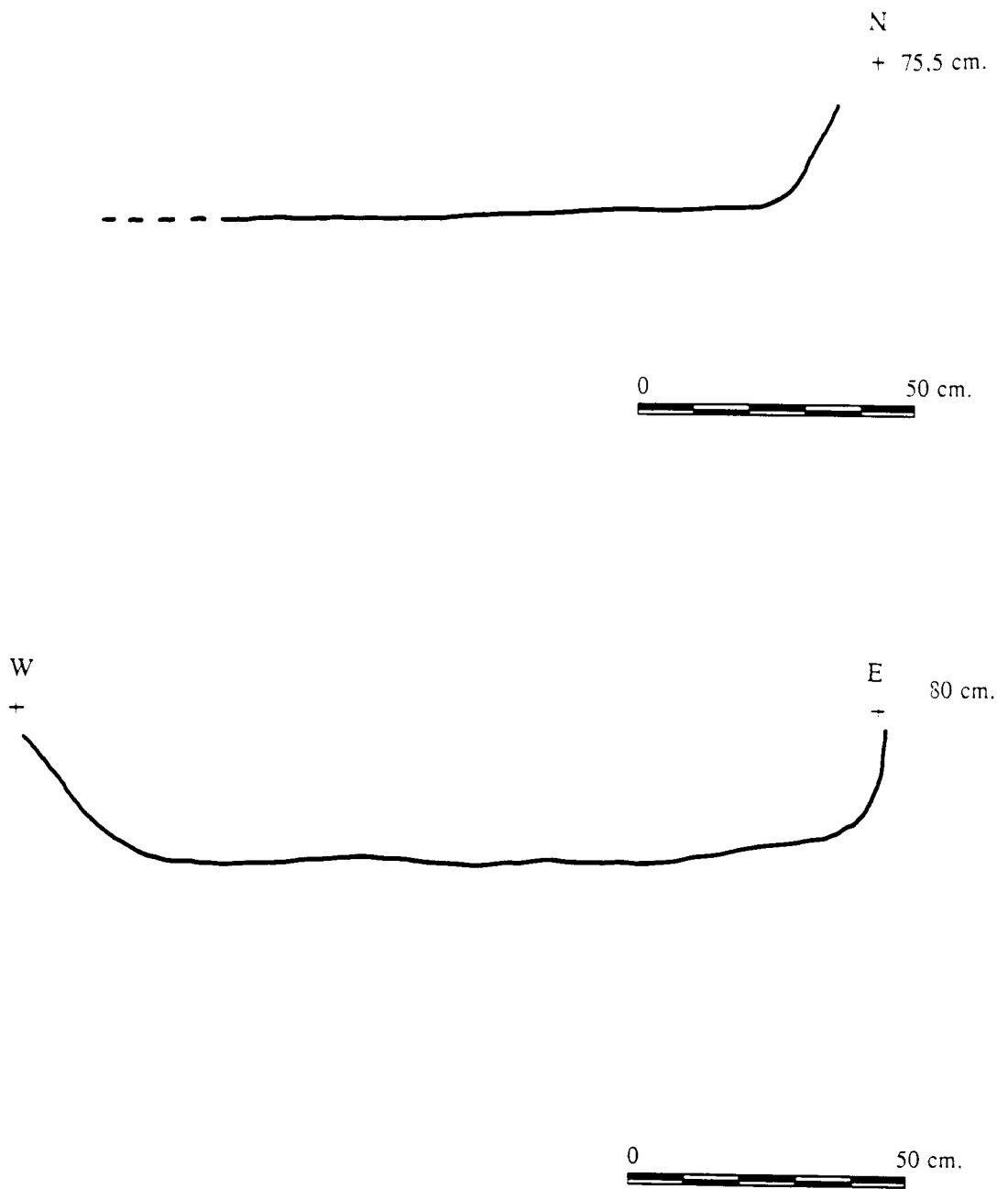

Fig. 55.- Seccions N/S i E/W de l'enterrament 11.2

ESTRUCTURA 11.2

Punt Zero = 176.31 m.  
Nivell a 0.50 m.

	Informe	Vas	Nansa	BNE	BPI	BPF	BNA	Molusc	TOTAL
Ceràmica	11	1	2						14
Silex				1	1	1			3
Conglomerat				3			7		10
Sorrenca							4		4
Calcària							4		4
Quars							5		5
RMI							38		38
Esquist							1		1
Granit							2		2
Indet				3			10		13
Orgànic								1	1
Os									
<b>Total</b>	<b>11</b>	<b>1</b>	<b>2</b>	<b>7</b>	<b>1</b>	<b>1</b>	<b>71</b>	<b>1</b>	<b>95</b>

### VI.2.2.- 11-3

La fossa presenta una forma ovalada. Quedava mig coberta per fragments de lloses de tortorà, i algun fragment de quars, que no acabaven de tancar l'espai excavat i reomplert. Algun d'aquests fragments sobrepassava la fossa indicant que havíem localitzat la boca original de la sepultura. La fossa estava excavada en el paquet d'argiles grogues amb carbonats.

Les restes d'aquest individu inhumat estaven molt deteriorades, fet que ha causat la desaparició de part dels ossos, però gràcies als conservats i a la seva posició s'ha pogut interpretar l'orientació ( Est/Oest) i posició del mort.

Es tractava d'un infant en el que la mandíbula es trobava en fase superior, lleugerament inclinada cap al sud i els molars restaven en posició, però sense el suport maxilar, ja desaparegut. Res més quedava del crani. La seva absència pot ser deguda a la pròpia fragilitat dels ossos, molt primers d'acord amb la curta edat de l'infant inhumat. Igualment podríem atribuir aquesta causa a la manca o extrema fragmentació d'altres ossos. El cos havia estat dipositat sobre l'esquena amb les cames plegades. El braç dret s'havia col·locat sobre l'espatlla esquerra i el braç esquerre, al llarg del cos, obrint-se una mica cap a l'exterior. En relació a les extremitats inferiors, mostren com la voluntat original era simplement plegar les cames mantenint els peus en posició funcional. El pes de les extremitats feia bascular les cames, que quedaven cap a un costat, si bé en aquest cas les reduïdes dimensions de la fossa permetien fixar el genoll, que restà en posició.

L'orientació del mort és NE/SW.

Pel que fa a l'aixovar que l'acompanyava, hi havia fragments de ceràmica, sis denes de calaita, una làmina i un trapezi sobre sílex, un possible punxó i la presència d'una falange de fauna (probablement oviceprín) (Figs. 56 i 57).

Fig. 56.- Planta de l'enterrament 11.3

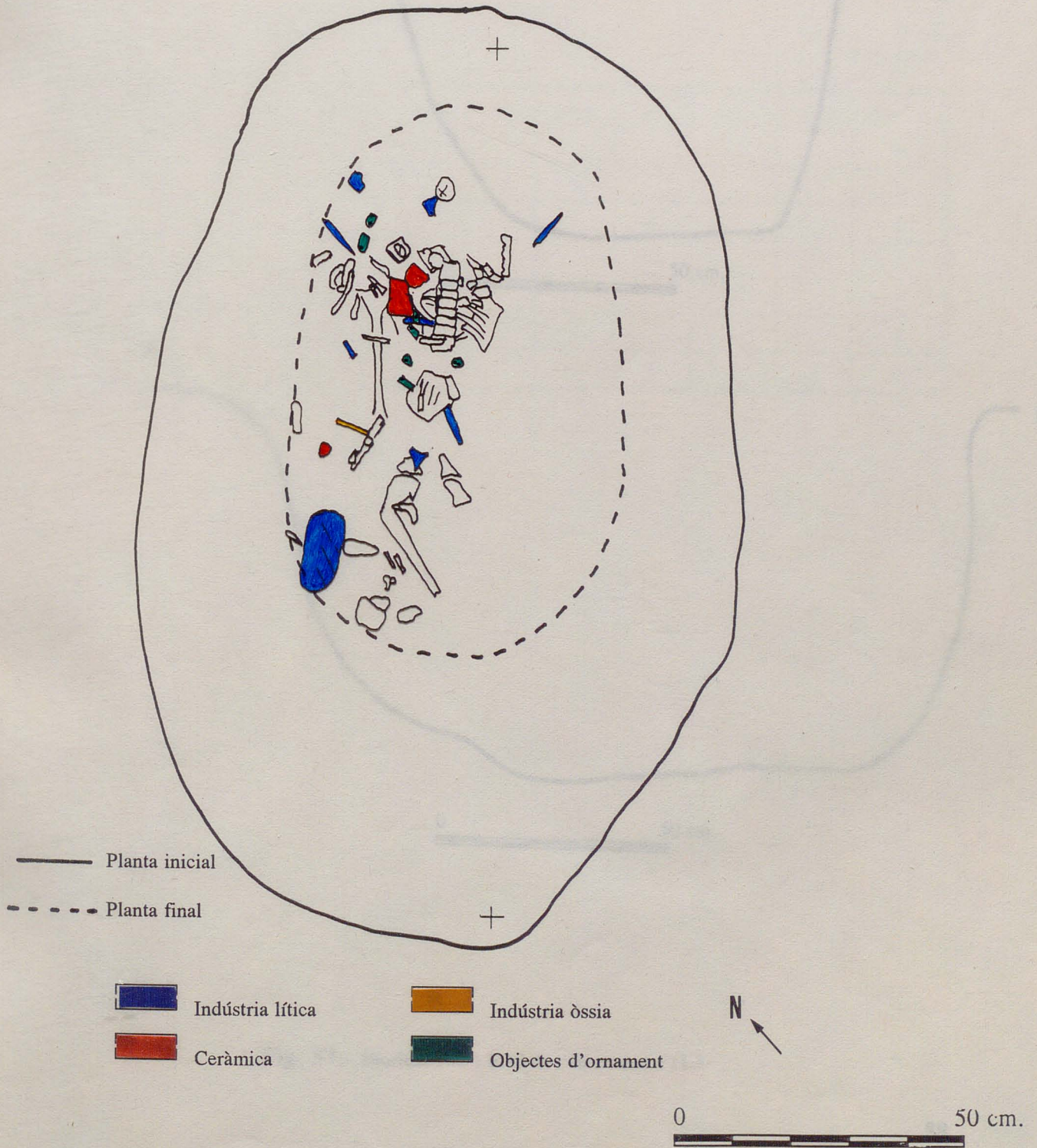

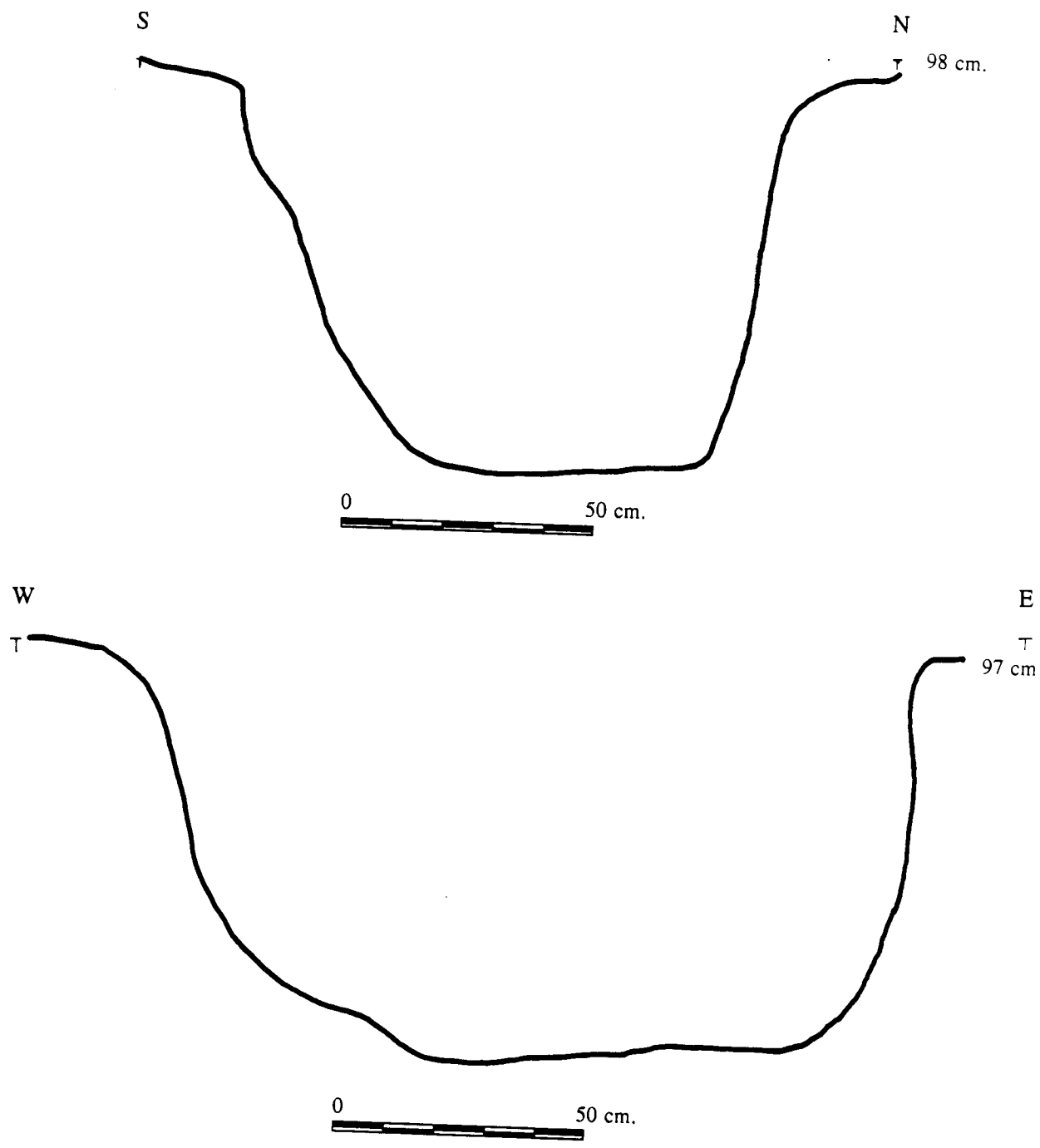

Fig. 57.- Seccions N/S i E/W de l'enterrament 11.3

ESTRUCTURA 11.3

Punt Zero = 176.31 m.  
Nivells a 0.50 m.

	Informe	Vora	Nansa	BPF	BP	BN2G	BNE	Molusc	Dena	TOTAL
Ceràmica	18	3	1							22
Sílex				2	5	3				10
RMI							2			2
Orgànic								2		2
Calaita									6	6
Os						3				3
<b>Total</b>	<b>18</b>	<b>3</b>	<b>1</b>	<b>2</b>	<b>5</b>	<b>6</b>	<b>2</b>	<b>2</b>	<b>6</b>	<b>45</b>

### VI.2.3.- 11.4

Fossa de forma ovalada amb la boca pràcticament tapada per grans blocs de conglomerat. Les parets baixaven verticalment arribant a una profunditat d'un metre. Estava excavada en el paquet d'argiles vermelles amb nòduls de carbonats.

Es tracta d'una sepultura d'individu adult. Estava col·locat amb l'esquena plana a la base de la fossa. El crani, força ben conservat, havia basculat sobre l'espatlla dreta i en el costat esquerre tenia dues pedres que sembla que el falcaven. No es trobava en connexió amb el crani. Les escàpules, molt deteriorades, semblaven estar encara en connexió amb els húmer. Pel que fa a l'avantbraç dret estava flexionat i reposava per sobre el tòrax, en canvi el braç esquerre estava semiflexionat al costat del cos i l'avantbraç per sobre la pelvis. Les mans no s'han conservat, excepte algunes falanges que no s'han trobat en posició anatòmica primària. Pel que fa a les costelles no s'han conservat, només algunes però sense estar en connexió i molt fracturades.

Les cames estarien flexionades, l'esquerre en posició vertical i recolzada contra la paret de la fossa. En canvi la cama dreta estaria flexionada i caiguda cap a l'esquerre. Només s'han conservat alguns ossos del peu dret.

L'orientació de l'individu era NE/SW.

Pel que fa a l'aixovar, hi havia una ceràmica de boca quadrada sencera, a més gran quantitat de sílex (trapezis, làmines, un nucli) (Figs. 58 i 59).



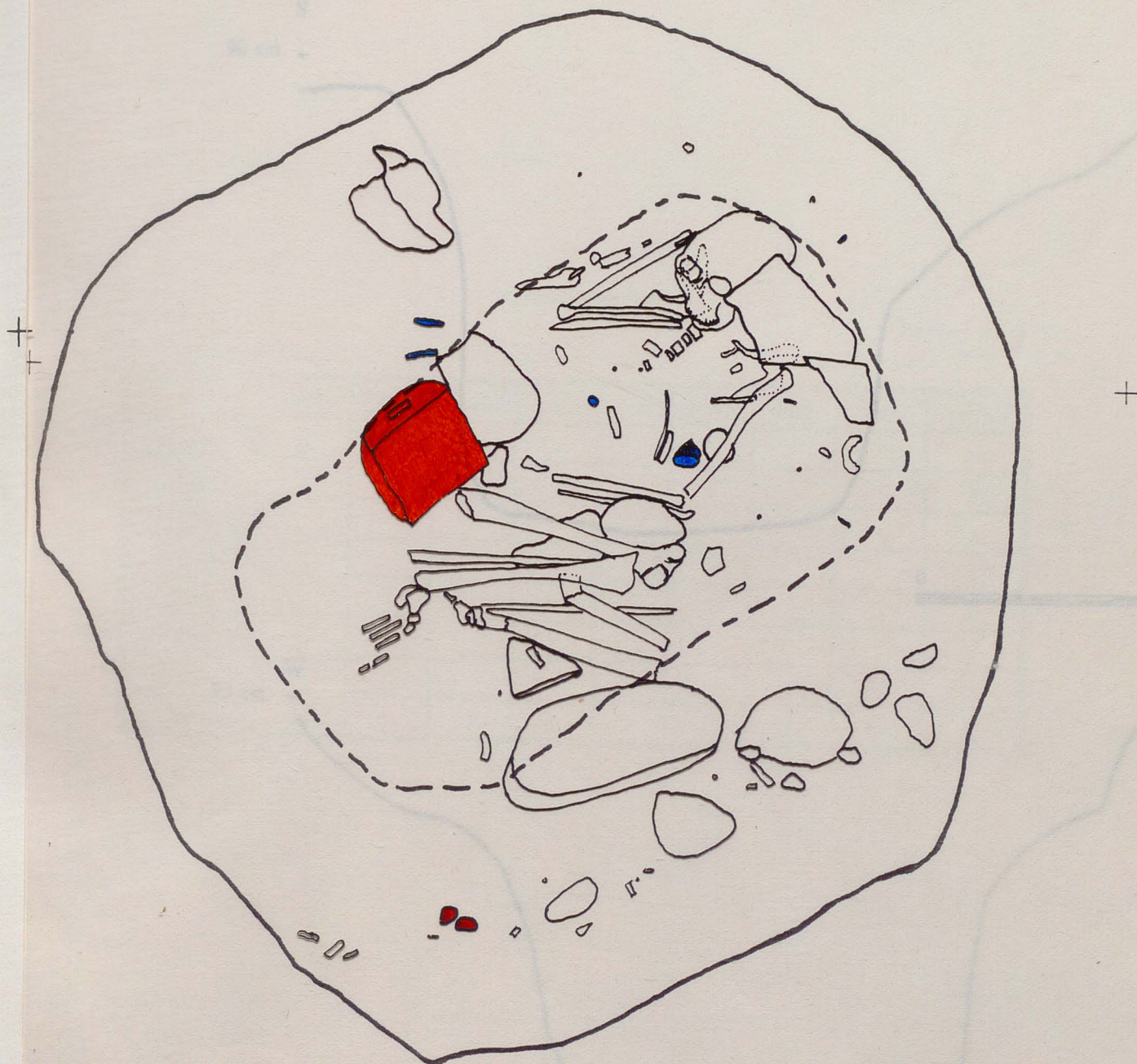

Fig. 58.- Planta de l'enterrament 11.4



Planta inicial ———

Planta final - - - - -

 Indústria lítica

 Indústria òssia

 Ceràmica

 Objectes d'ornament

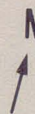

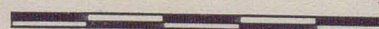
0  50 cm.



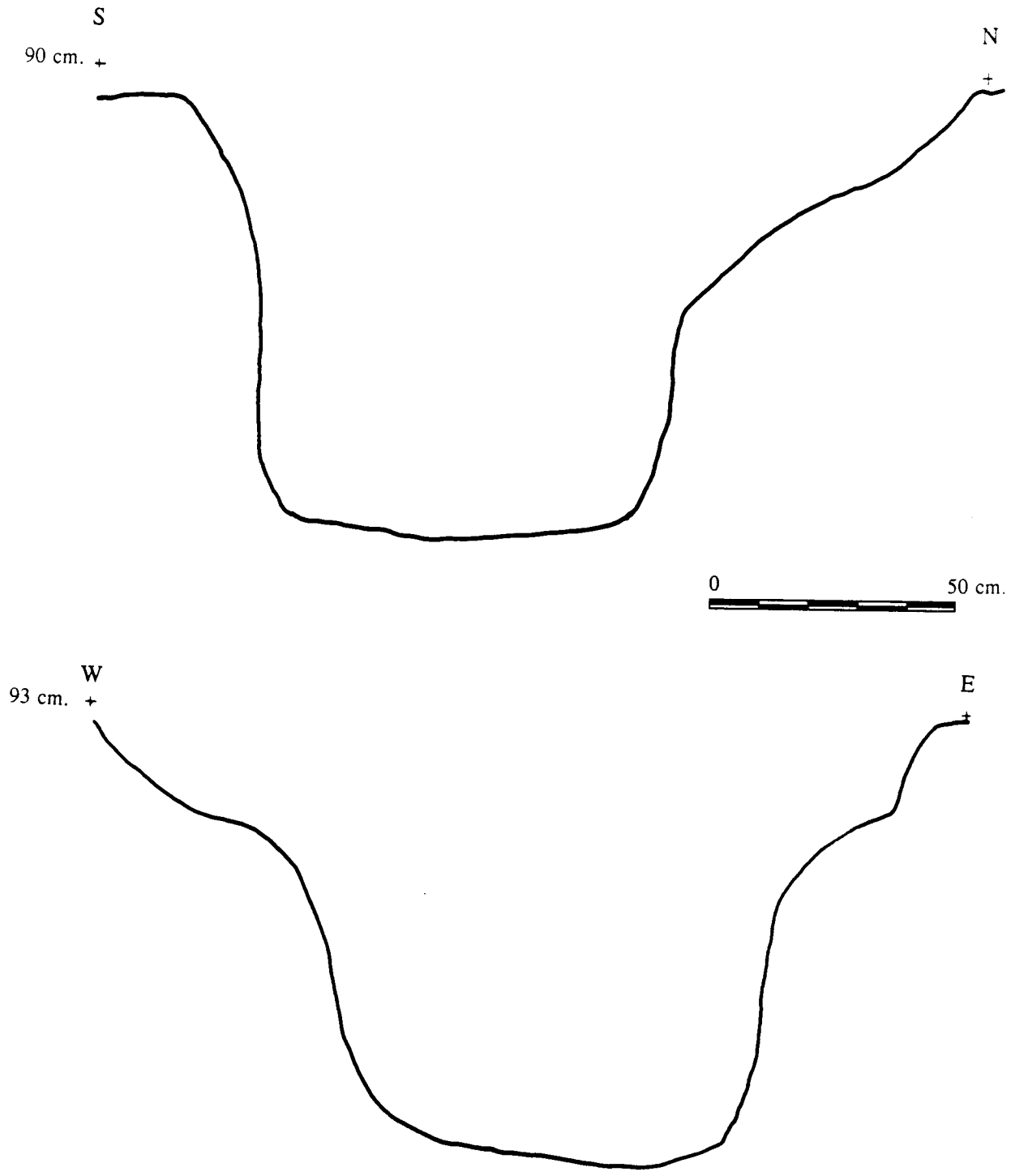

Fig. 59.- Seccions N/S i E/W de l'enterrament 11.4

ESTRUCTURA 11.4

Punt Zero = 176.31 m.  
Nivell a 0.50 m.

	Informe	Vas	Vora	BN2G	BP	BN1G	BNE	BNA	TOTAL
Ceràmica	24	1	3						28
Sílex				3	3	1			7
Conglomerat								4	4
Sorrenca								5	5
Calcària								7	7
Quars								1	1
RMI							1	11	12
<b>Total</b>	<b>24</b>	<b>1</b>	<b>3</b>	<b>3</b>	<b>3</b>	<b>1</b>	<b>1</b>	<b>28</b>	<b>64</b>

### VI.3.- ILLA I

En aquesta illa només s'hi va excavar una sepultura (Fig. 60).

#### VI.3.1.- I-5

En aquesta estructura no va ser possible aconseguir determinar els seus límits, ja que aquests no van ser detectables en cap moment de la seva excavació . L'únic que s'hi va trobar van ser un nombre reduït de restes humanes, probablement d'un individu jove ateses les dimensions de la mandíbula. Ha estat impossible de determinar la major part dels ossos, donada la seva mala conservació i alt grau de fracturació. Tampoc ha estat possible interpretar la seva posició. Conjuntament a tot això hi havia també una placa de tortorà inclinada cap al nord que cobria part d'aquests ossos (Fig. 61).

ESTRUCTURA I.5

Punt Zero = 176.95 m.  
Nivell a 0.80 m.

	Informe	TOTAL
Ceràmica	1	1
<b>Total</b>	<b>1</b>	<b>1</b>

Fig. 60.- Localització de l'enterrament a l'illa I

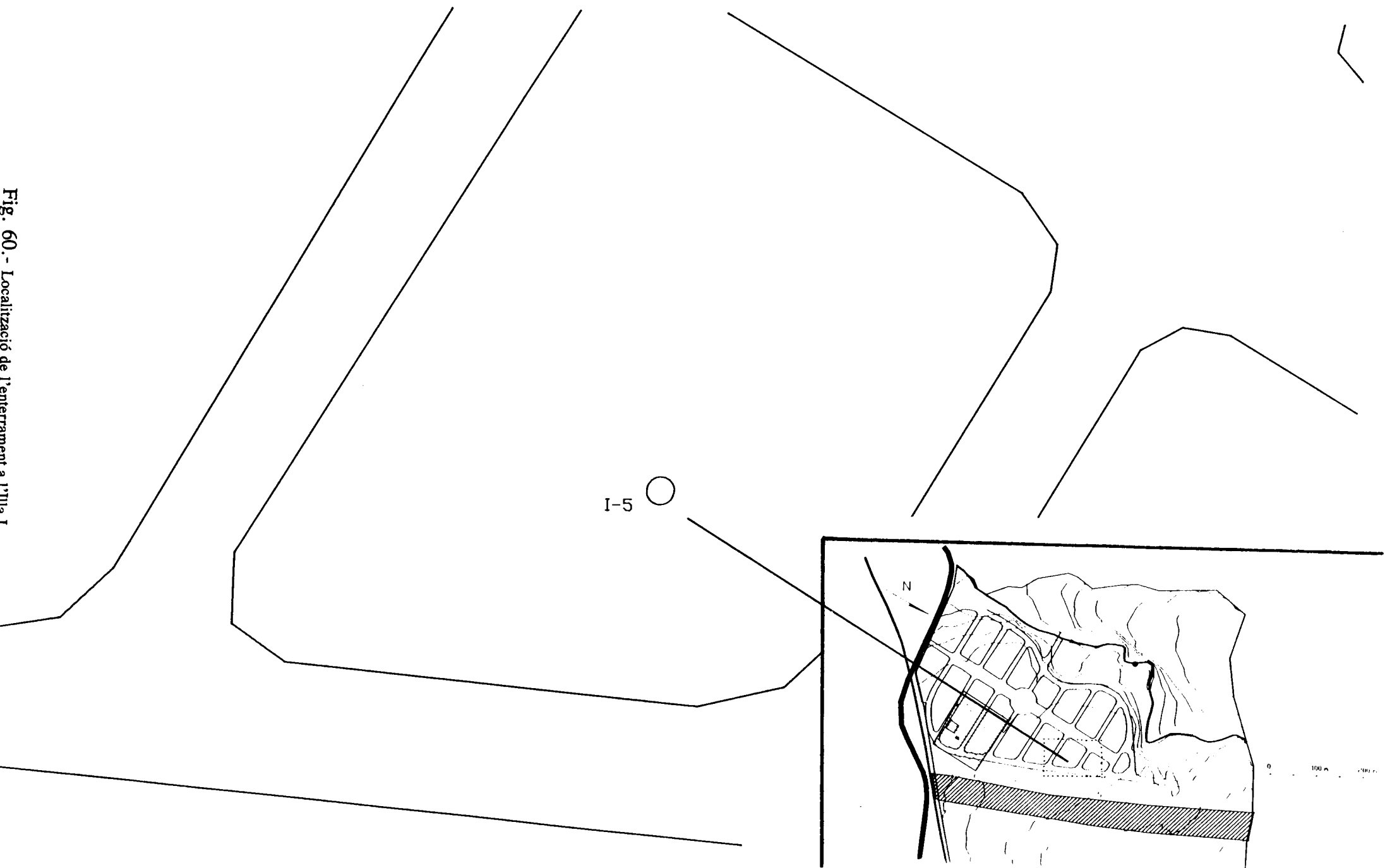

Fig. 61.- Planta de l'enterrament I.5

VI.4.- ILLA M

En aquesta illa van ser 11 les sepultures excavades (Fig. 62).

VI.4.1.- M-5

+

+

Estructura de grans dimensions, en un principi feia uns 280 cms. de diàmetre màxim però aquesta línia es reduïa a uns 140 cms. Excavada a les argiles vermelles amb alçada de carbonís. En el moment es van trobar tres destals i alguns ossos probablement humans. Un cop acabada la fossa aquesta feia uns 90 cms d'alçada i uns 140 cms de diàmetre. A més, també s'aportà una dona de calça i una destal polida (Fig. 61, 64 i 65).

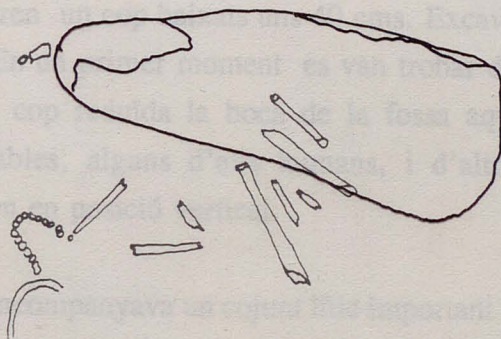

Planta inicial ———

Planta final - - - - -



Indústria lítica



Indústria òssia



Ceràmica



Objectes d'ornament



0



50 cm

## VI.4.- ILLA M

En aquesta illa van ser 11 les sepultures excavades (Fig. 62).

### VI.4.1.- M-5

Estructura de grans dimensions, en un principi feia uns 280 cms. de diàmetre màxim però aquests límits es reduïren un cop baixats uns 40 cms. Excavada a les argiles vermelles amb nòduls de carbonats. En un primer moment es van trobar dues destrals i alguns ossos probablement humans. Un cop reduïda la boca de la fossa aquesta baixava uns 90 cm. apareixent ossos determinables, alguns d'ells humans, i d'altres dubtosos però mai en connexió, sovint es trobaven en posició vertical.

A tots aquests ossos acompanyava un cojunt lític important sobre sílex compost de dos nuclis amb talla laminar, trapezis, làmines. A més, també aparegué una dena de calaïta i una destral polida (Figs. 63,64 i 65).

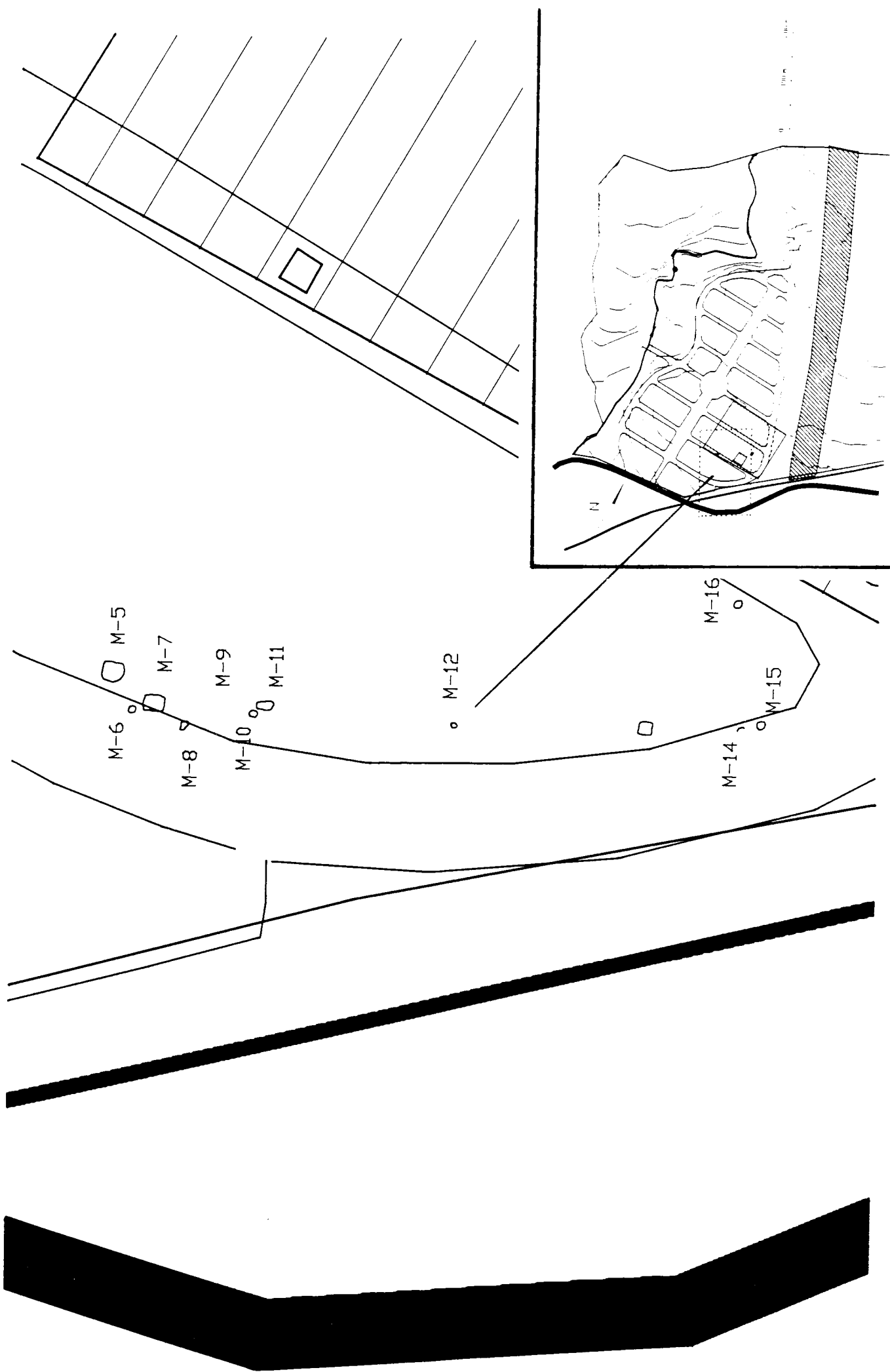
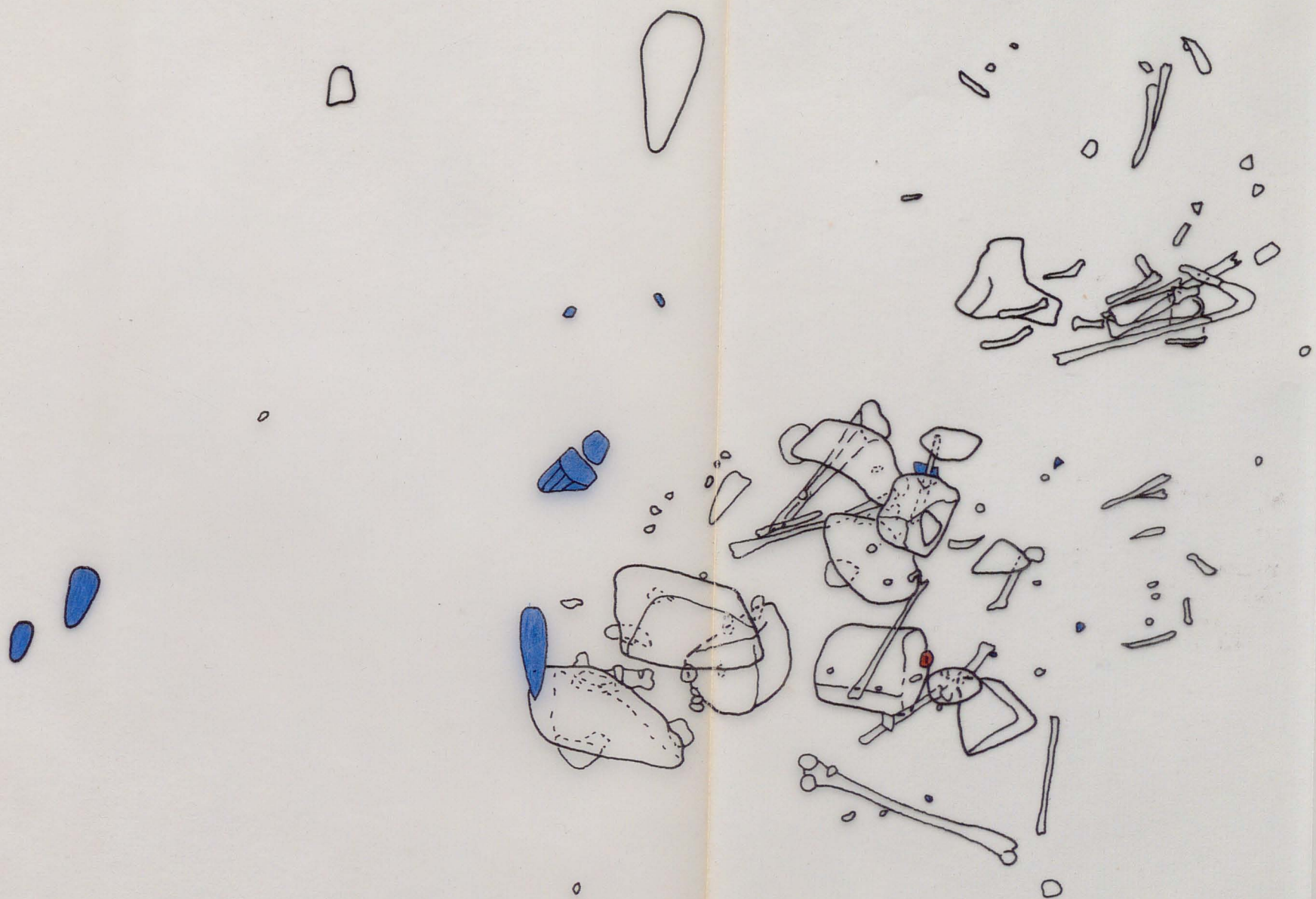

Fig. 62.- Localització dels enterraments a l'Illa M.







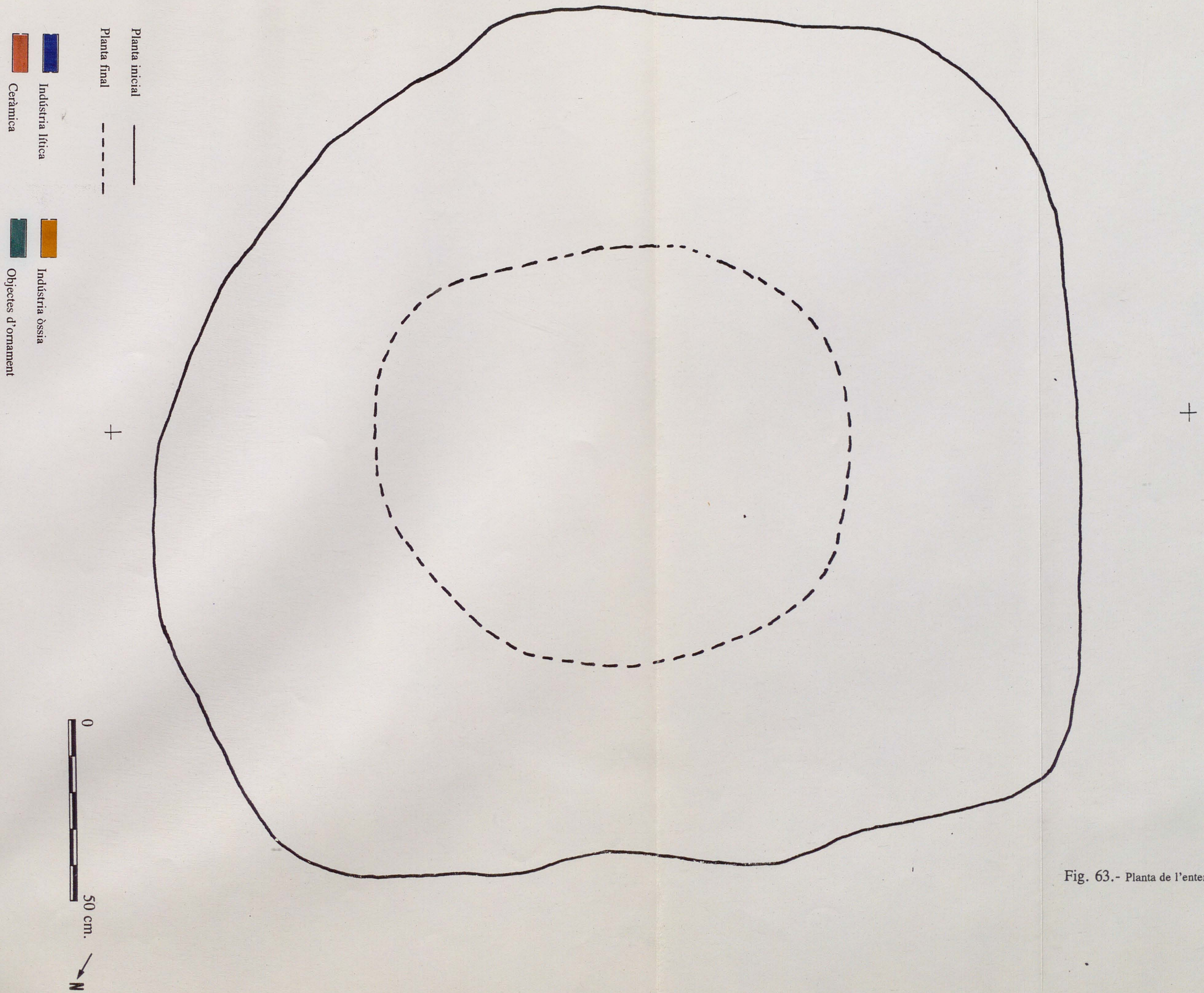

Fig. 63.- Planta de l'enterrament M.5



S  
+ 170 cm.

N  
+ 170 cm.

Fig. 64.- Secció N/S de l'enterrament M.5

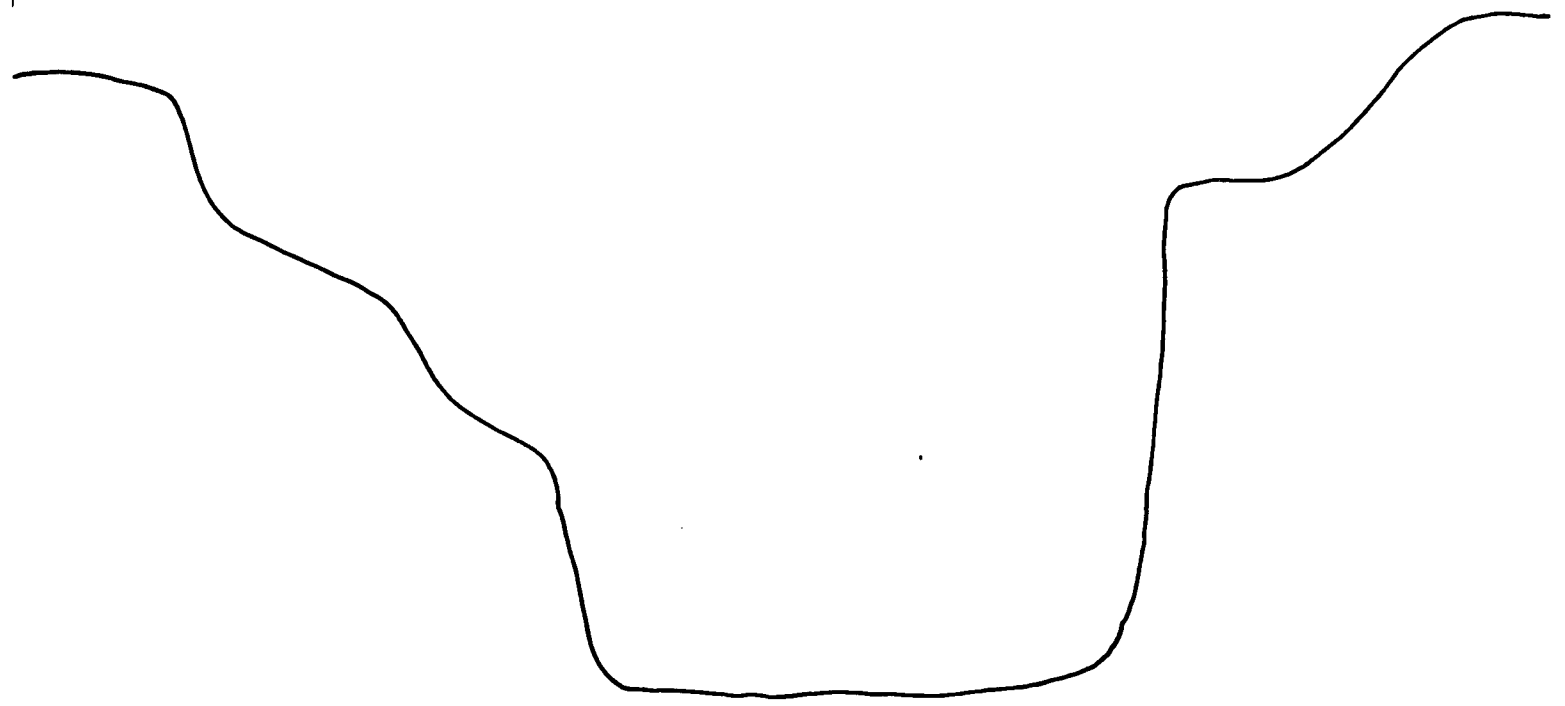

0 50 cm.

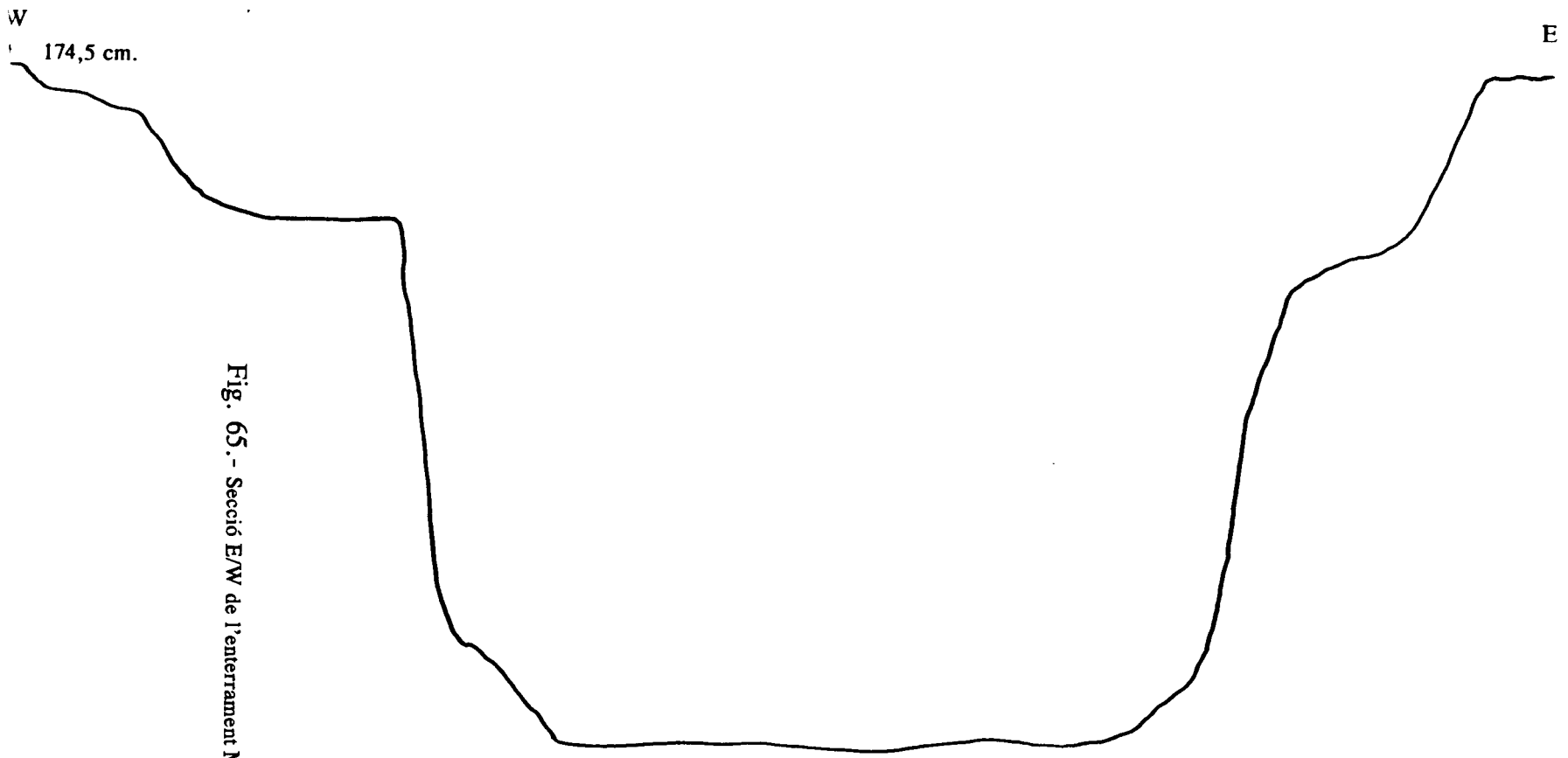

Fig. 65.- Secció E/W de l'enterrament M.5



ESTRUCTURA M.5

Punt Zero = 173.27 m.  
Nivell a 1 m.

	Informe	Vora	Aplica	BN2G	BP	BPF	BPI	BP2G	BNIG	BNA	BNE	Dena	Molusc	TOTAL
Ceràmica	41	3	1											45
Sílex				8	1	7		1	2					19
Calcària						1				1				2
Quars						7	4	2		6				19
RMI										8	1			9
Granit										1				1
Conglomerat										2				2
Sorrencia										1				1
Calaiña												1		1
Orgànic													4	4
Indet										1	4			5
<b>Total</b>	<b>41</b>	<b>3</b>	<b>1</b>	<b>8</b>	<b>1</b>	<b>15</b>	<b>4</b>	<b>3</b>	<b>2</b>	<b>20</b>	<b>5</b>	<b>1</b>	<b>4</b>	<b>108</b>

## VI.4.2.- M-6

Estructura rodona excavada en les argiles grogues amb carbonats. S'hi van trobar escasses restes òssies probablement humanes però degut al seu mal estat de conservació no ha estat possible determinar-les. Estava acompanyat d'un fragment quasi sencer de ceràmica de boca quadrada, (va ser robada) (Fig. 66 i 67).

## ESTRUCTURA M.6

Punt Zero = 173.27 m.  
Nivell a 1 m.

	Informe	BP	TOTAL
Ceràmica	5		5
Silex		1	1
<b>Total</b>	<b>5</b>	<b>1</b>	<b>6</b>

Fig. 66.- Planta de l'enterrament M.6

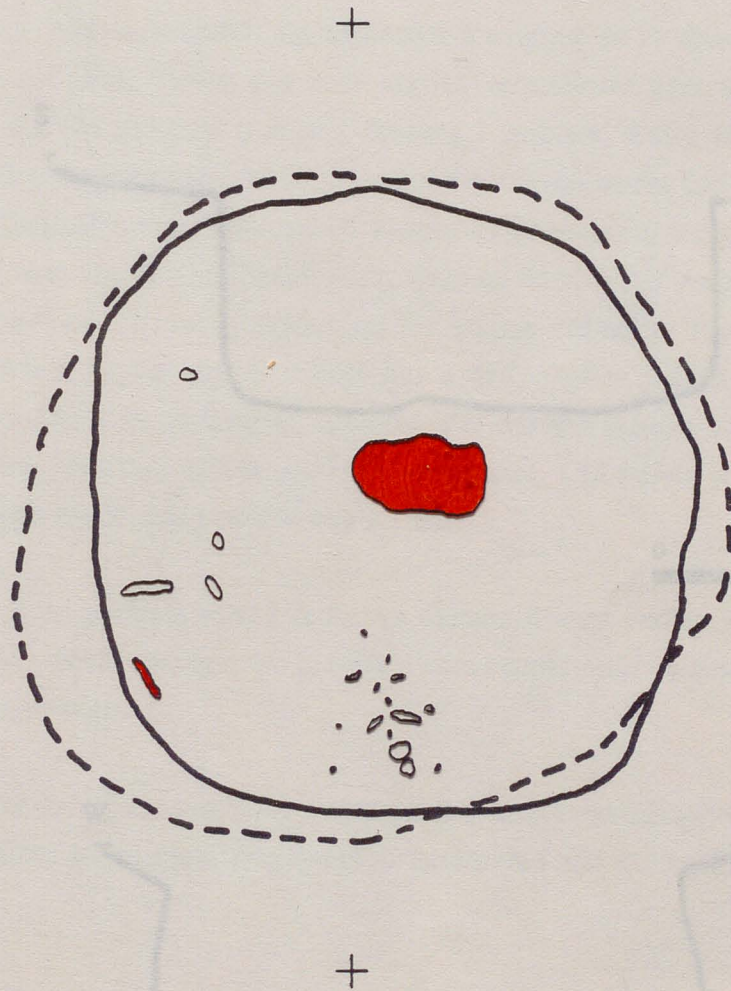



Planta inicial ———

Planta final - - - - -

 Indústria lítica

 Indústria òssia

 Ceràmica

 Objectes d'ornament

→ N

0 105 50 cm



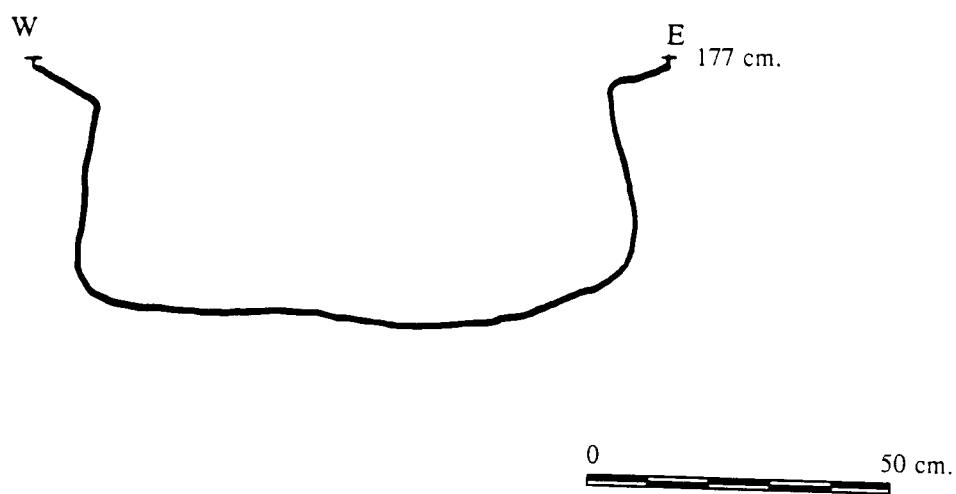

Fig. 67.- Seccions N/S i E/W de l'enterrament M.6

#### VI.4.3.- M-7

Enterrament en pou rectangular. En començar a excavar es va diferenciar dos tipus de reompliment, un a l'Oest, format per unes argiles vermelloses amb alguns nòduls de carbonats; un altre a l'Est compost d'argiles fosques i carbons. Entre els dos canvis es trobaven pedres de dimensions entre 10 i 30 cms. que semblaven tancar cap el Sud. A l'hora d'excavar es van individualitzar els dos canvis. Primer es va seguir el situat a l'Est, que en ser buidat anava formant una fossa circular però, quan es donava per acabada a la base es va determinar un canvi de sediment marcat per les argiles vermelles sense carbonats. A l'interior, el reompliment seguia sent el mateix que a dalt, argiles groguenques. Aquestes argiles van determinar una fossa rectangular i, a dins, s'hi trobava el mort. Aquest no restava en connexió anatòmica, sinó que estava totalment desmuntat. Les parets baixaven verticals i la base era plana amb un lleuger pendent cap a l'Est.

El crani estava en perfecte estat i reposava damunt d'unes pedres sota les quals va aparèixer la pelvis. Al voltant aparegueren la resta d'ossos sense estar en connexió i amb cap tipus de disposició anatòmica.

Pel que fa a l'aixovar, van aparèixer, superposats, varis punxons sobre os de diferents mides, trapezis i làmines sobre sílex, fragments de ceràmica i una dena (Figs. 68, 69 i 70).







Fig. 68.- Planta de l'enterrament M.7

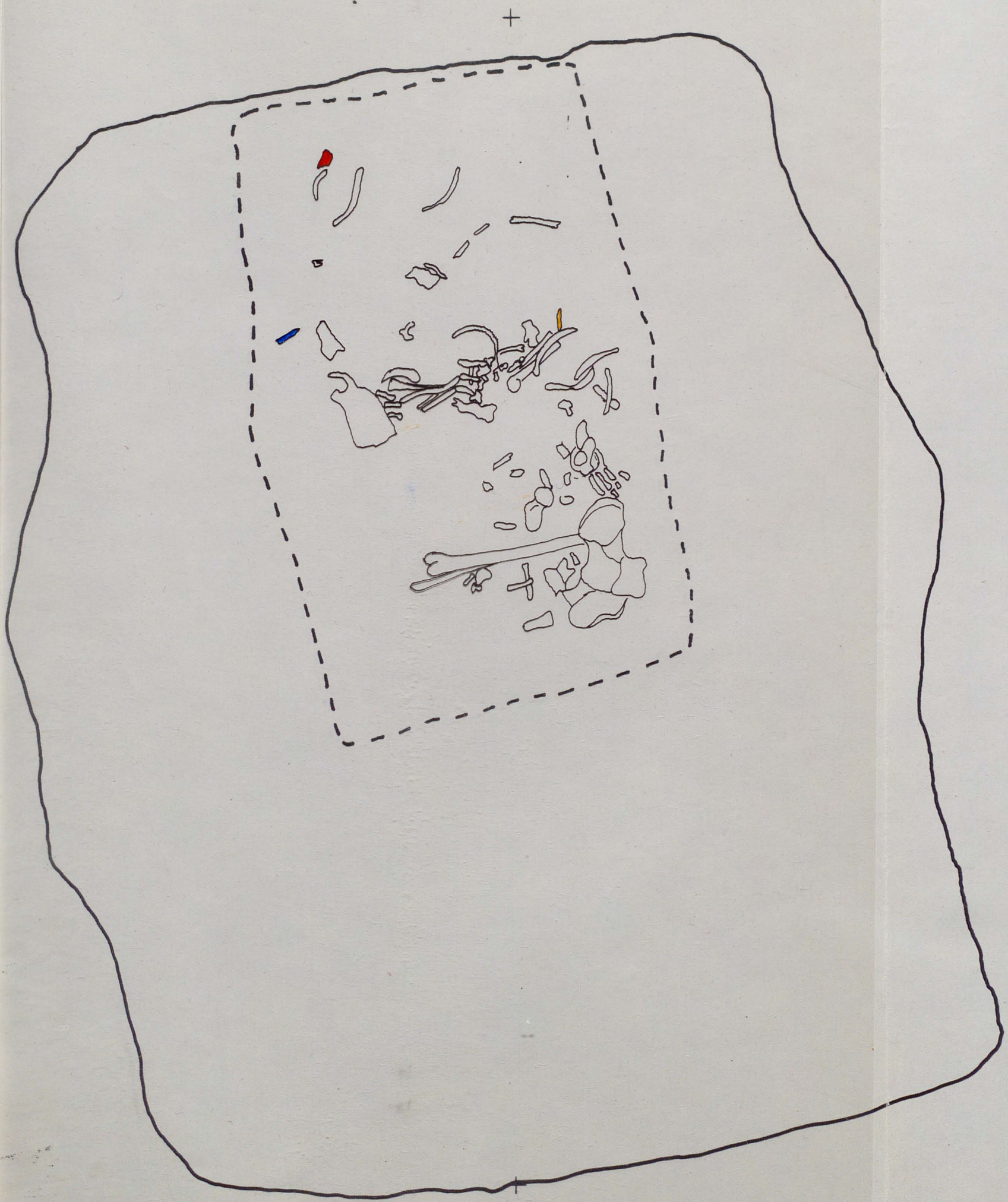

Planta inicial ———

Planta final - - - - -



Indústria lítica



Ceràmica



Indústria òssia



Objectes d'ornament

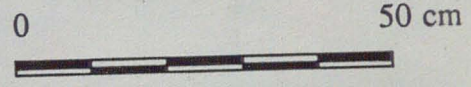



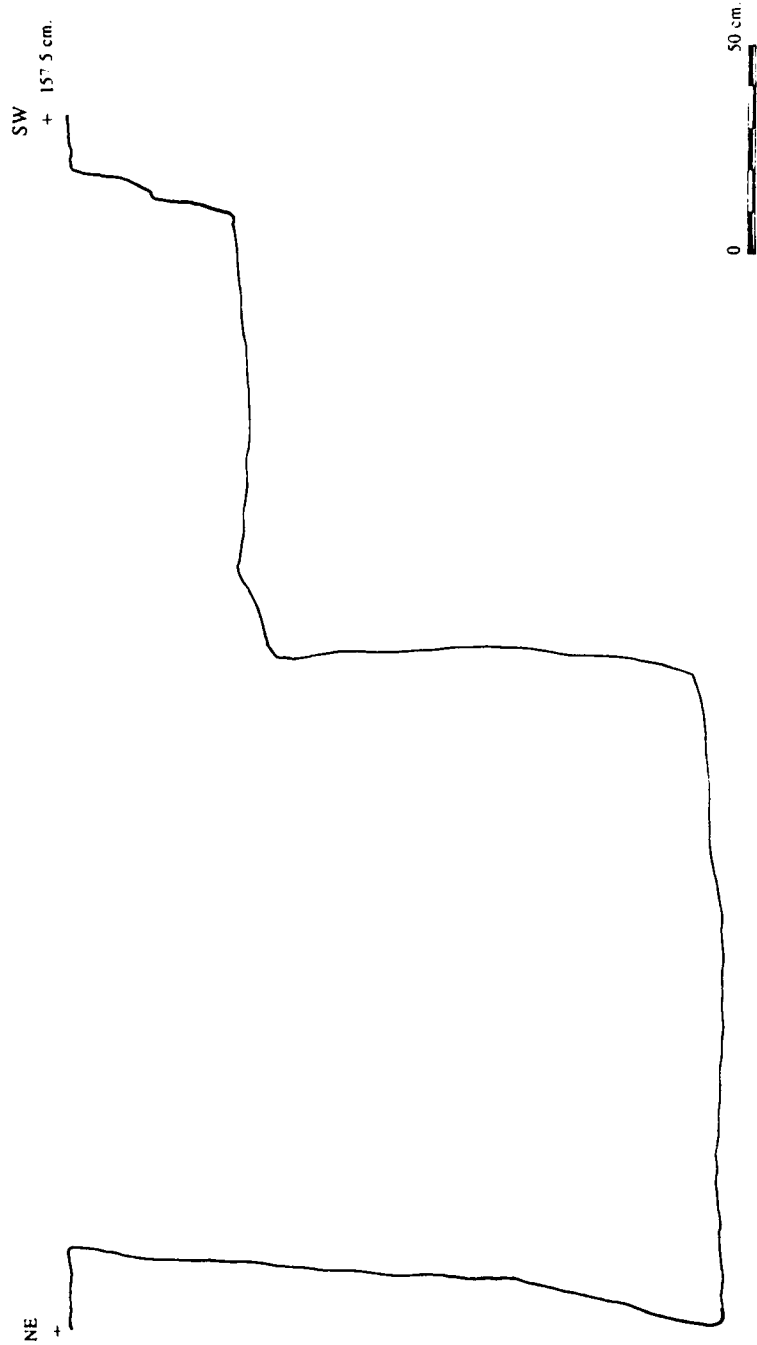

Fig. 69.- Secció NE/SW de l'enterrament M.7

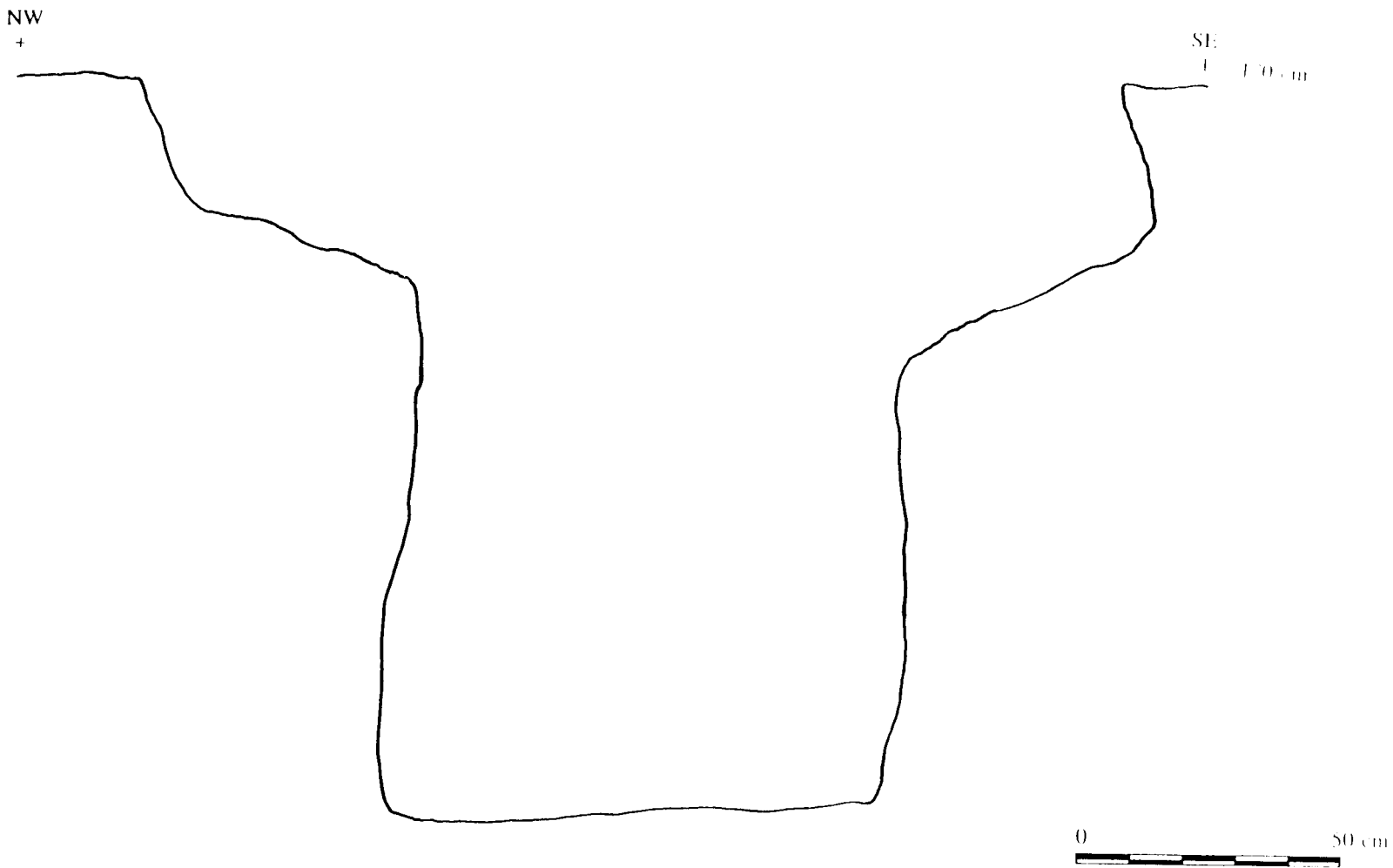

Fig. 70. - Secció NW/SE de l'enterrament M.7.

ESTRUCTURA M.7

Punt Zero = 173.27 m.  
Nivell a 1 m.

	Informe	Vora	Nansa	Panxa	Carena	Aplica	Frag	TOTAL
Ceràmica	111	6	1	1	1	1		121
Tovot							1	1
<b>Total</b>	<b>111</b>	<b>6</b>	<b>1</b>	<b>1</b>	<b>1</b>	<b>1</b>	<b>1</b>	<b>122</b>

	BP	BPF	BN2G	BP2G	BNA	BNE	Dena	TOTAL
Silex	1	3	5					9
Quars		2		3	10			15
RMI					35	2		37
Conglomerat					6	2		8
Sorrenca					14	3		17
Calcària					7			7
Esquist					2	1		3
Granit					2			2
Os			10					10
Calàita							1	1
<b>Total</b>	<b>1</b>	<b>5</b>	<b>15</b>	<b>3</b>	<b>76</b>	<b>8</b>	<b>1</b>	<b>109</b>

## VI.4.4.- M-8

Estructura excavada en part en les argiles grogues amb nòduls de carbonats, i en part a les argiles vermelles. De forma irregular, estant constituïda per un primer replà de base, i una segona base, que potser constituïria la sepultura pròpiament dita.

En el primer replà aparegué una sepultura molt mal conservada, amb restes de les extremitats inferiors, versemblantment *in situ* per la seva posició característica, un crani molt mal conservat, capgirat i trocejat, i un vas ceràmic sencer com a únic aixovar. En el segon nivell aparegueren restes òssies segurament humanes, també molt mal conservades, distingint-ne un fragment de crani, un coxal, una diàfisi d'os llarg i multitud d'estelles molt degradades.

Aquesta disposició de les restes planteja que ; o bé es tractaria d'una inhumació doble, molt mal conservada, o bé ens trobem davant les restes d'un mateix individu, que han estat remogudes *a posteriori* (Figs. 71,72 i 73).

## ESTRUCTURA M.8

Punt Zero = 173.27 m.  
Nivell a 1 m.

	Informe	Vas	Vora	BPF	BP	BN2G	BPI	BNA	Molusc	TOTAL
Ceràmica	117	1	13							131
Sílex				4		1	1			6
Quars				1	1		1			3
Calcària								6		6
RMI								10		10
Orgànic									1	1
<b>Total</b>	<b>117</b>	<b>1</b>	<b>13</b>	<b>5</b>	<b>1</b>	<b>1</b>	<b>2</b>	<b>16</b>	<b>1</b>	<b>157</b>

Fig. 71.- Planta de l'enterrament M.8

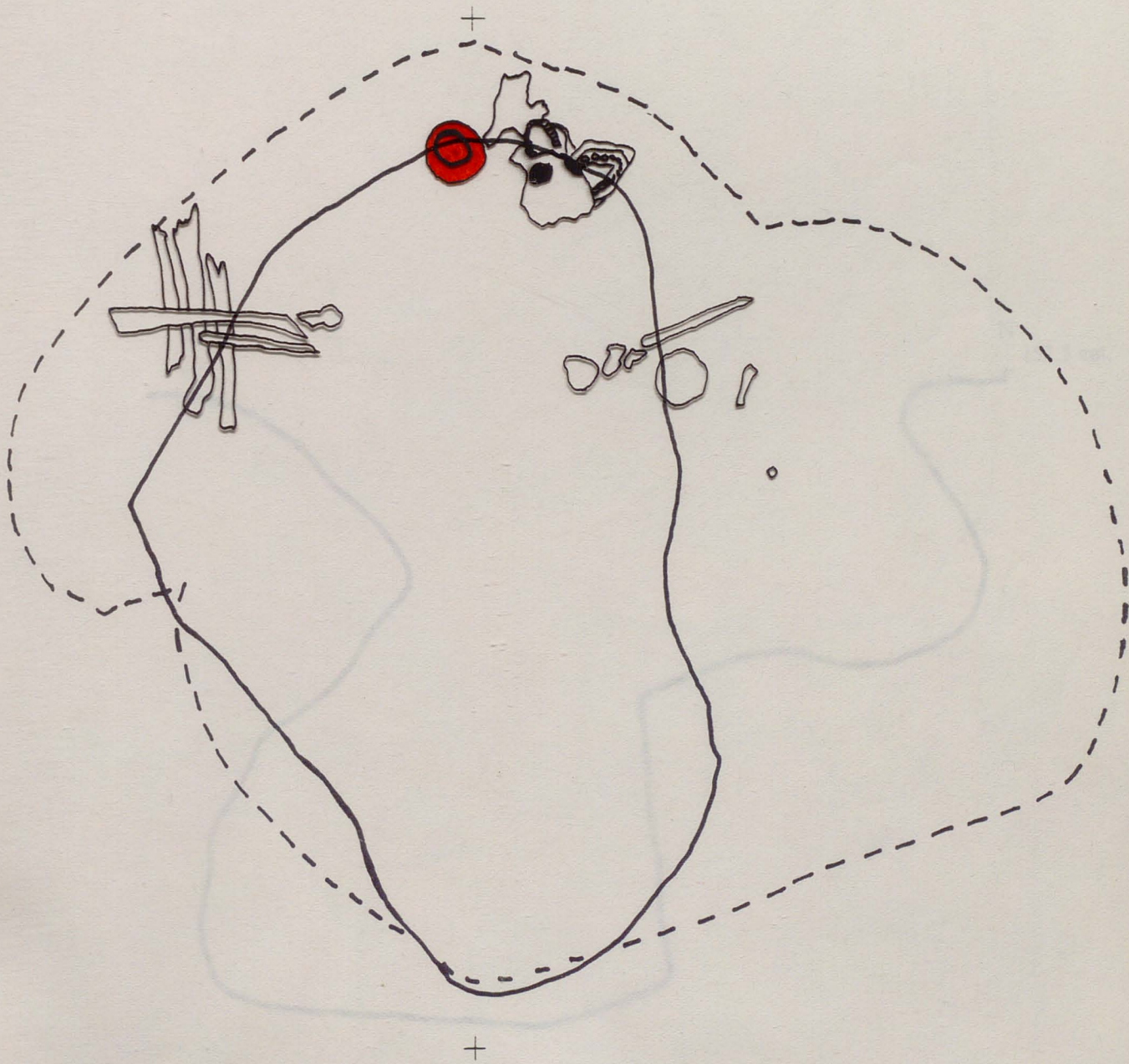

Planta inicial ———

Planta final - - - - -



Indústria lítica



Indústria òssia



Ceràmica



Objectes d'ornament



0

50 cm.



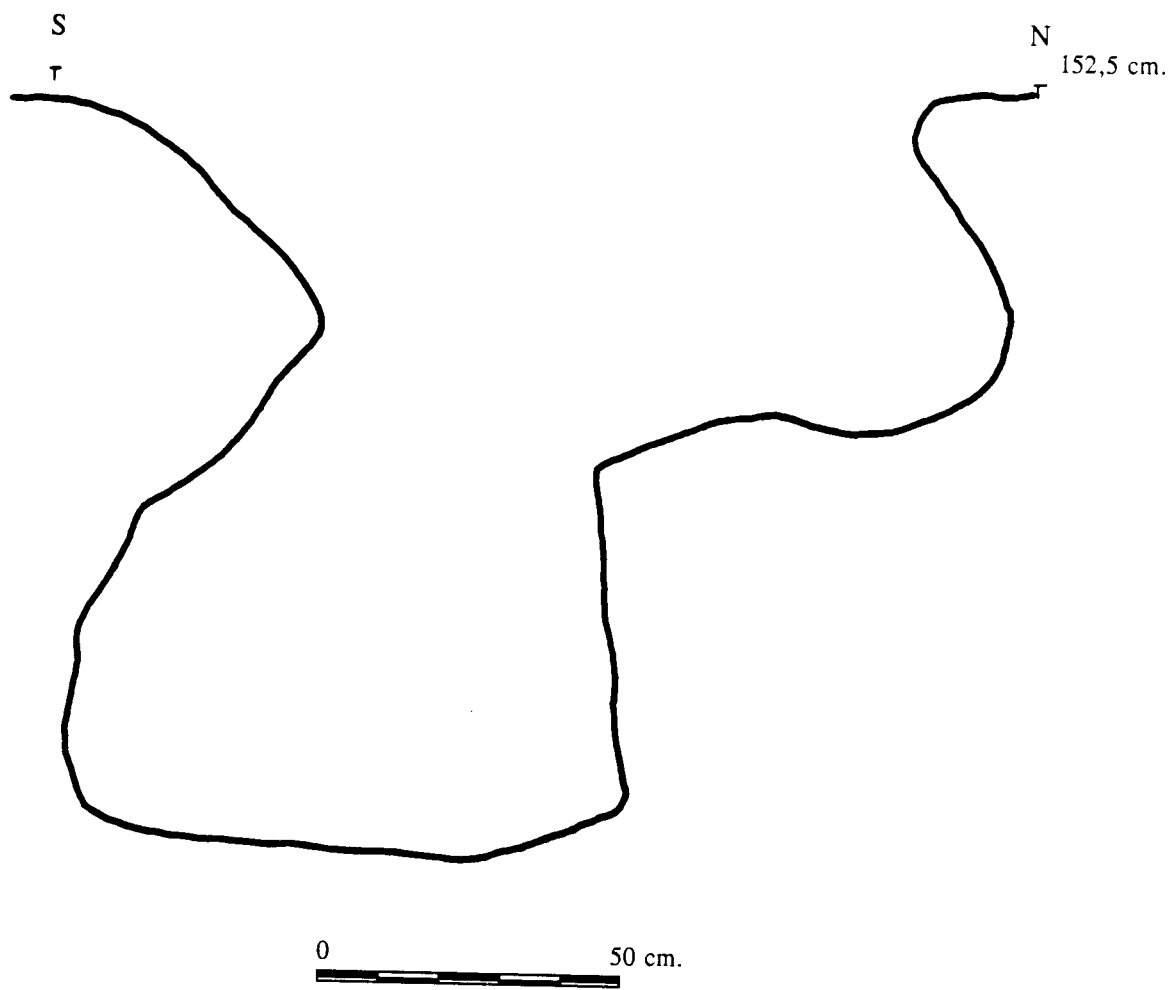

Fig. 72.- Secció N/S de l'enterrament M.8.



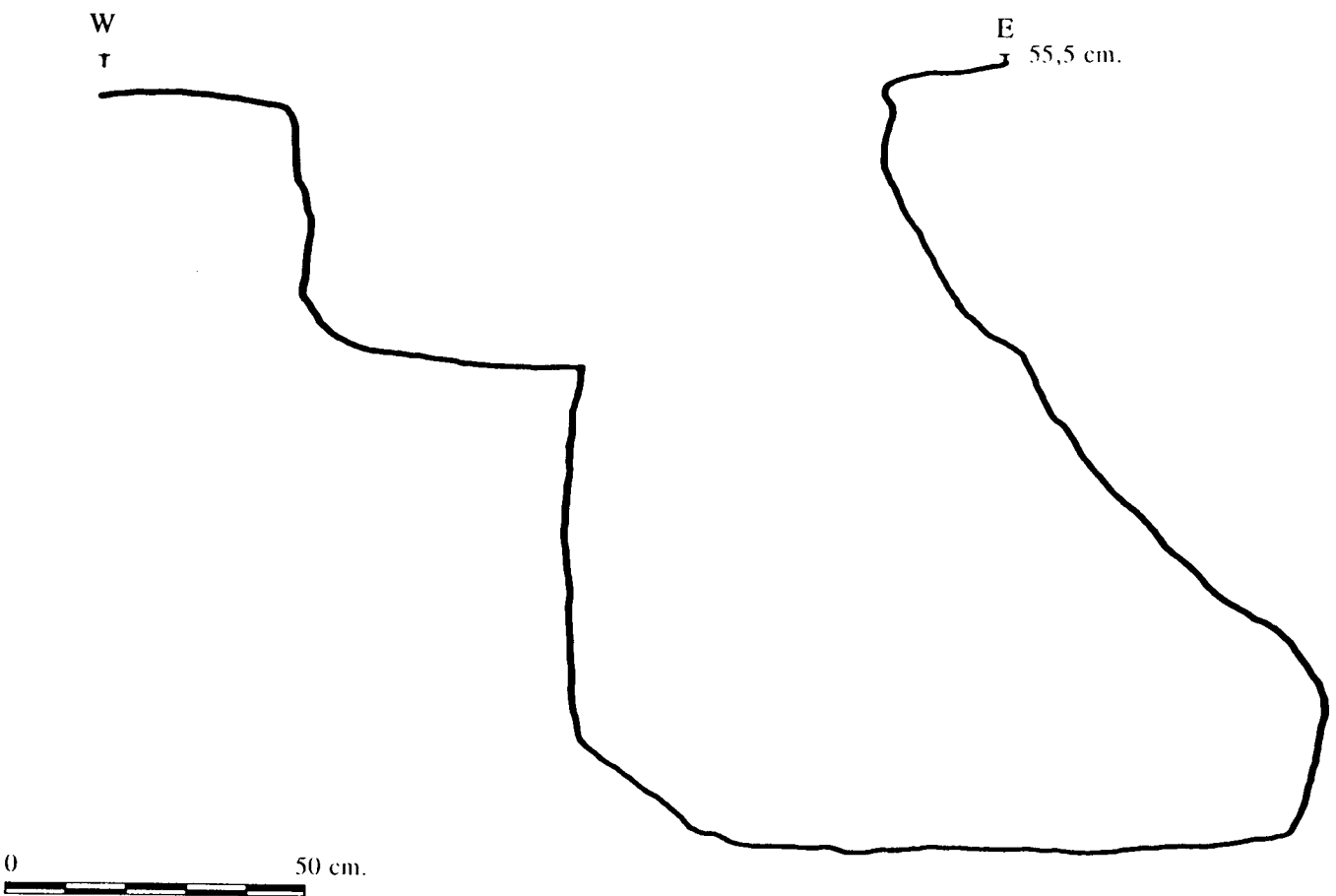

Fig. 73. - Secció E/W de l'enterrament M.8.

## VI.4.5.- M-9

Estructura ovalada, mig coberta per plaques de tortorà, alguns d'uns 20 cms. d'espessor. Les parets baixaven força verticals (aproximadament 80 cms. de profunditat). Es trobava excavada en el paquet d'argiles grogues amb nòdols de tortorà.

La boca de la fossa és més petita del que s'obre cap a l'interior ja que a l'est la fossa s'amplia uns 30 cms.

Ens trobem a l'interior amb el cos humà d'un adult. És a l'Est on hi haurà col·locat el cap, aquest es troba força fragmentat. En tota la part del tòrax els ossos estaven remoguts i molt fragmentats, fent impossible la seva localització original i la seva determinació.

La pelvis tampoc es conservava en la seva totalitat, només les cames eren les que semblaven estar *in situ*, aquestes estaven flexionades i tombades ambdues cap al costa dret. Els peus no es van conservar, només alguns ossos del peu dret.

El cos estava orientat d'est a oest.(Figs. 74,75 i 76).

Acompanyat al cos inhumat hi havia alguna làmina de sílex i denes de calaïta, al voltant del crani i entre els braços.

## ESTRUCTURA M.9

Punt Zero = 173.27 m.

Nivell a 1 m.



	Informe	Vas	BP	BPF	BN2G	BP2G	BN1G	BNA	Dena	TOTAL
Ceràmica	12	1								13
Sílex			2	2	1	1	1			7
Calcària								1		1
RMI								2		2
Quars				1						1
Calaïta									20	20
<b>Total</b>	<b>12</b>	<b>1</b>	<b>2</b>	<b>3</b>	<b>1</b>	<b>1</b>	<b>1</b>	<b>3</b>	<b>20</b>	<b>44</b>

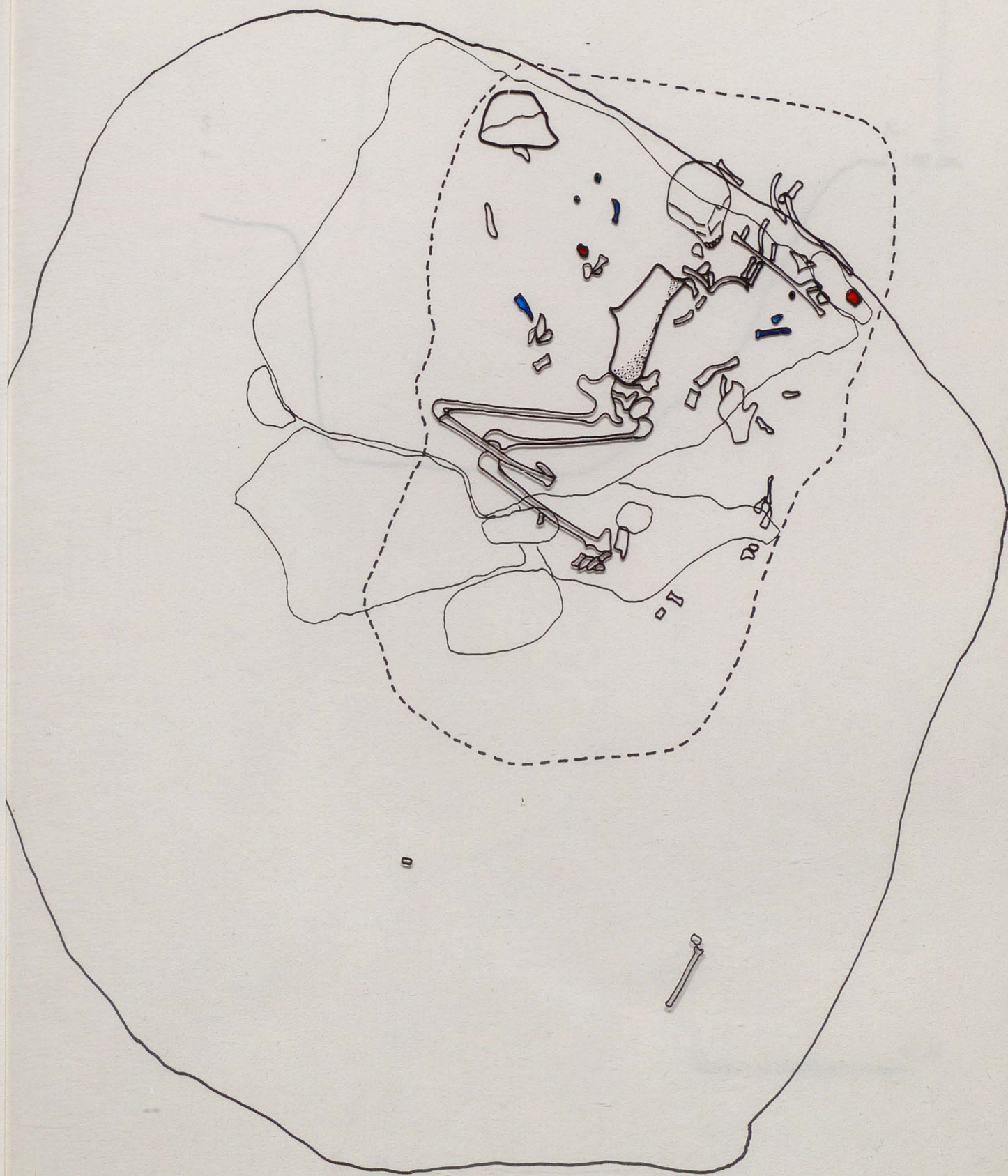

Fig. 74.- Planta de l'enterrament M.9.



Planta inicial ———

Planta final - - - - -

 Indústria lítica  
 Ceràmica

 Indústria òssia  
 Objectes d'ornament

0 50 cm.

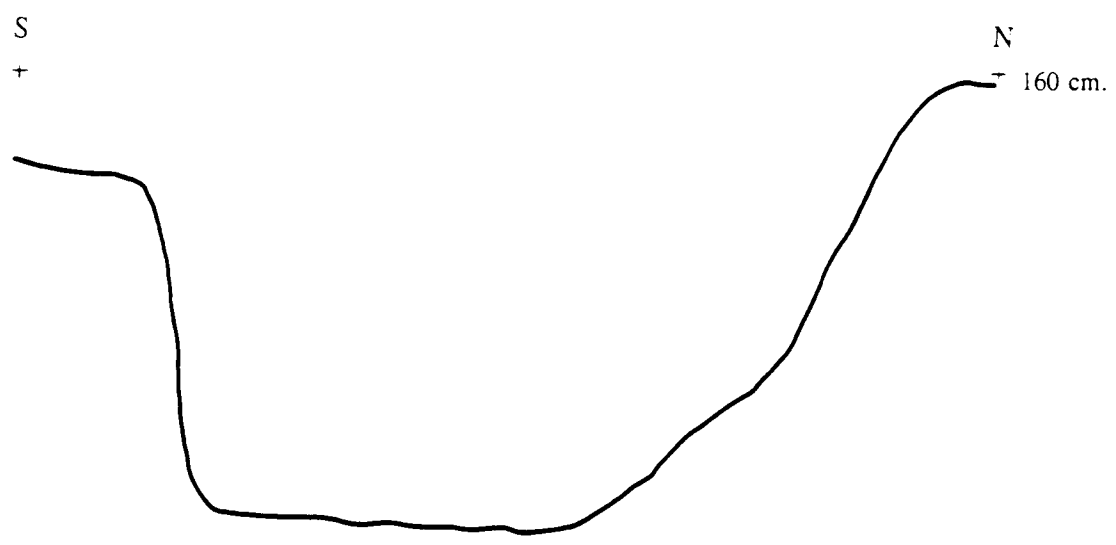

Fig. 75.- Secció N/S de l'enterrament M.9

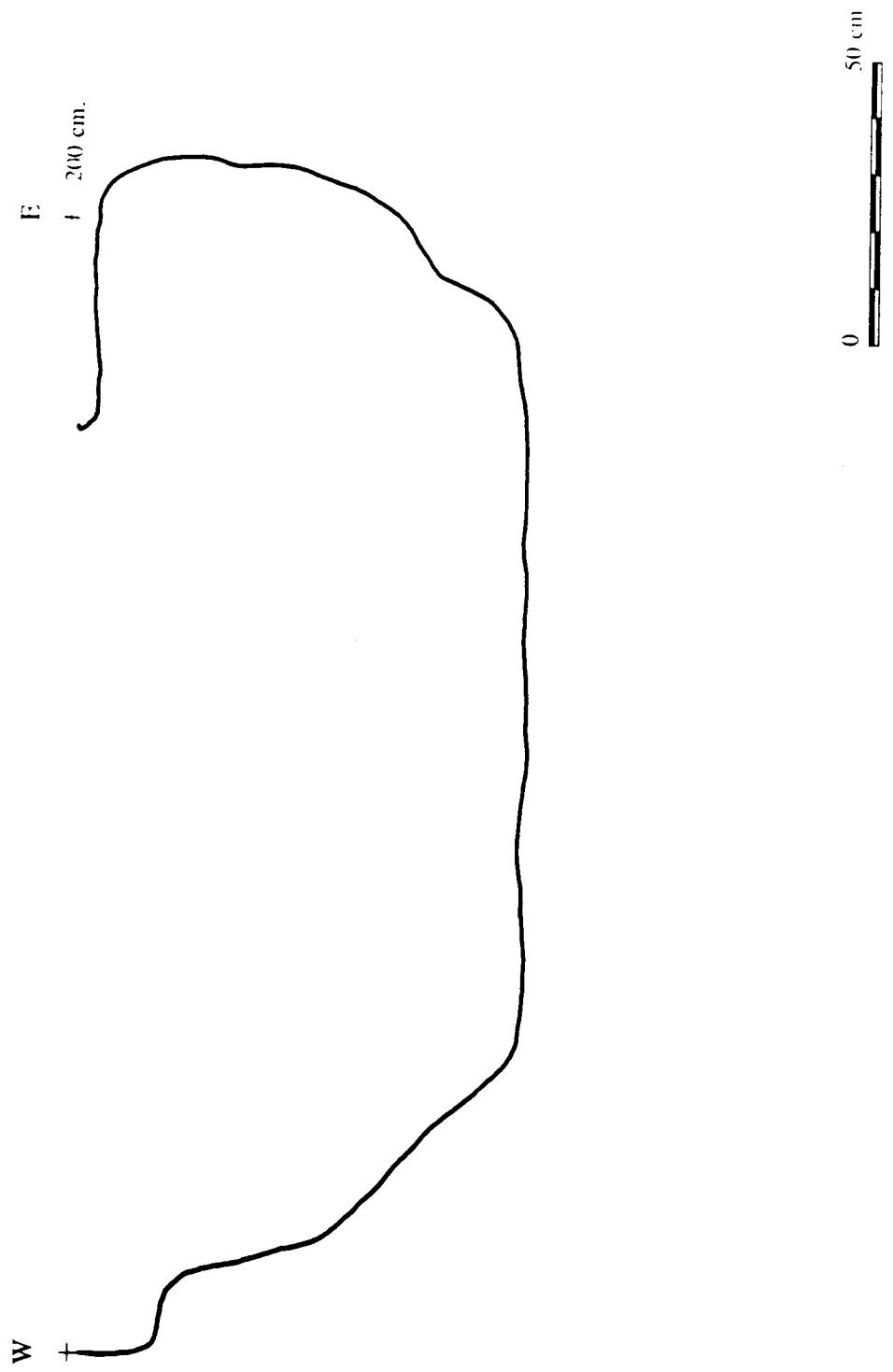

Fig. 76.- Secció E/W de l'enterrament M.9

## VI.4.6.- M-10

Sepultura de petites dimensions de forma ovalada. Les parets eran rectes i el fons pla. A l'interior un enterrament d'un individu jove (infant) en posició fetal, recolzat sobre el costat dret. El crani es trobava molt alterat i destruït. No ha estat possible recuperar la totalitat dels ossos degut al seu mal estat. Unicament els ossos trobats en connexió van ser els de les extremitats inferiors (sense peus).

La resta dels ossos estaven dispersos sense connexió anatòmica.

De l'aixovar que l'acompanyava cal destacar la presència d'unes 10 denes de calaïta, localitzades totes elles una al costat de l'altre, probablement formant un collaret (Figs. 77 i 78).

## ESTRUCTURA M.10

Punt Zero = 173.27 m.  
Nivell a 1 m.

	Informe	BPF	BNA	Dena	BN2G	TOTAL
Ceràmica	5					5
Quars		1				1
Conglomerat			1			1
Calaïta				10		10
Os					1	1
<b>Total</b>	<b>5</b>	<b>1</b>	<b>1</b>	<b>10</b>	<b>1</b>	<b>18</b>



Fig. 77.- Planta de l'enterrament M.10

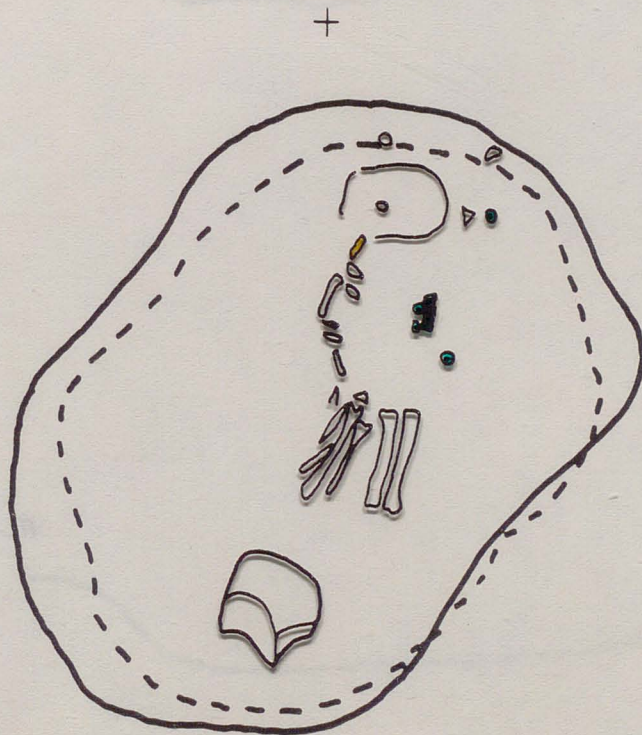

Planta inicial ———

Planta final - - - - -



Indústria lítica



Indústria òssia



Ceràmica



Objectes d'ornament



0 50 cm.

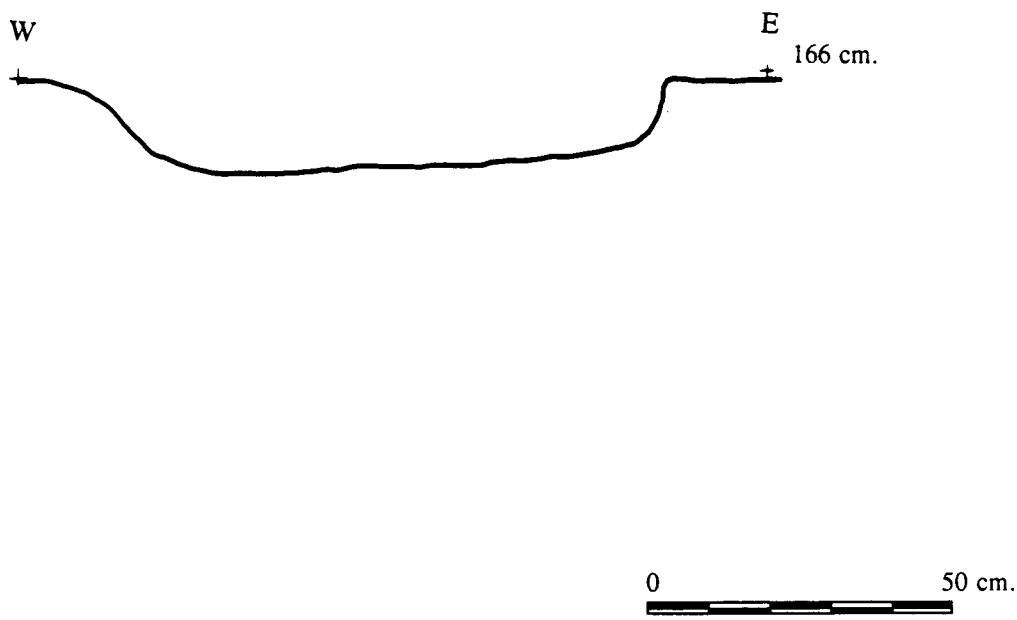
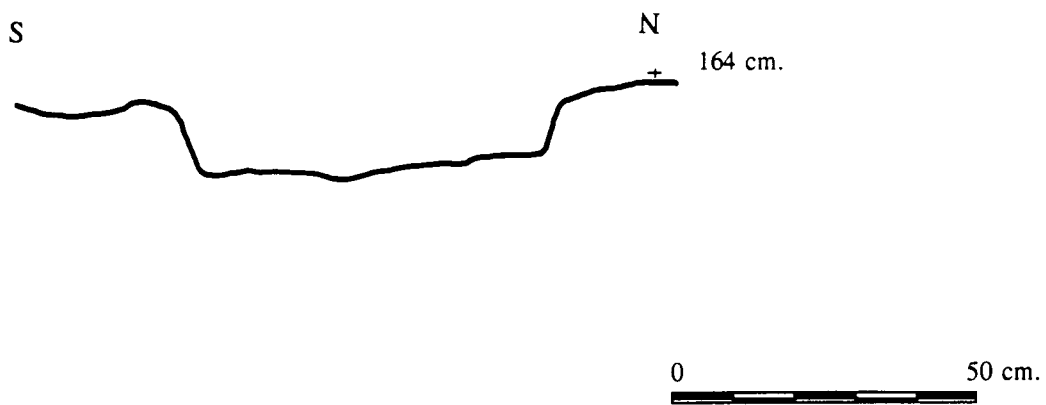

Fig. 78.- Seccions N/S i E/W de l'enterrament M.10



## VI.4.7.- M-11

Fossa ovalada que a mida que es baixava la fossa s'ampliava cap al NE. Al capdevall del cos hi havia unes pedres que anirien de costat a costat de la fossa com tancant al cos i a més seguint el pendent de la base de la sepultura, podent parlar potser d'una petita rampa cap el mort tancada per pedres. A l'interior hi trobem un cos humà adult. Aquest es trobava amb l'esquena plana a terra, el cap força ben conservat no semblava estar mogut.

El braç esquerre es trobava semiflexionat al costat del cos, en canvi l'avantbraç del dret estava flexionat sobre el tòrax, això ho trobem gràcies al cúbit i radi que estaven al costat de l'húmer en connexió i per les falanges, que encara no essent-hi totes, es trobaven per sobre de les costelles.

Les cames estaven flexionades i tombades cap al costat esquerre, els peus no s'han conservat.

Acompanyant al cos hi havia, sota l'humer dret, un vaset ceràmic sencer, al costat una làmina de sílex i també a l'altre costat una destrat polida.

El cos estava orientat de NE-SW (Figs. 79,80 i 81).

## ESTRUCTURA M.11



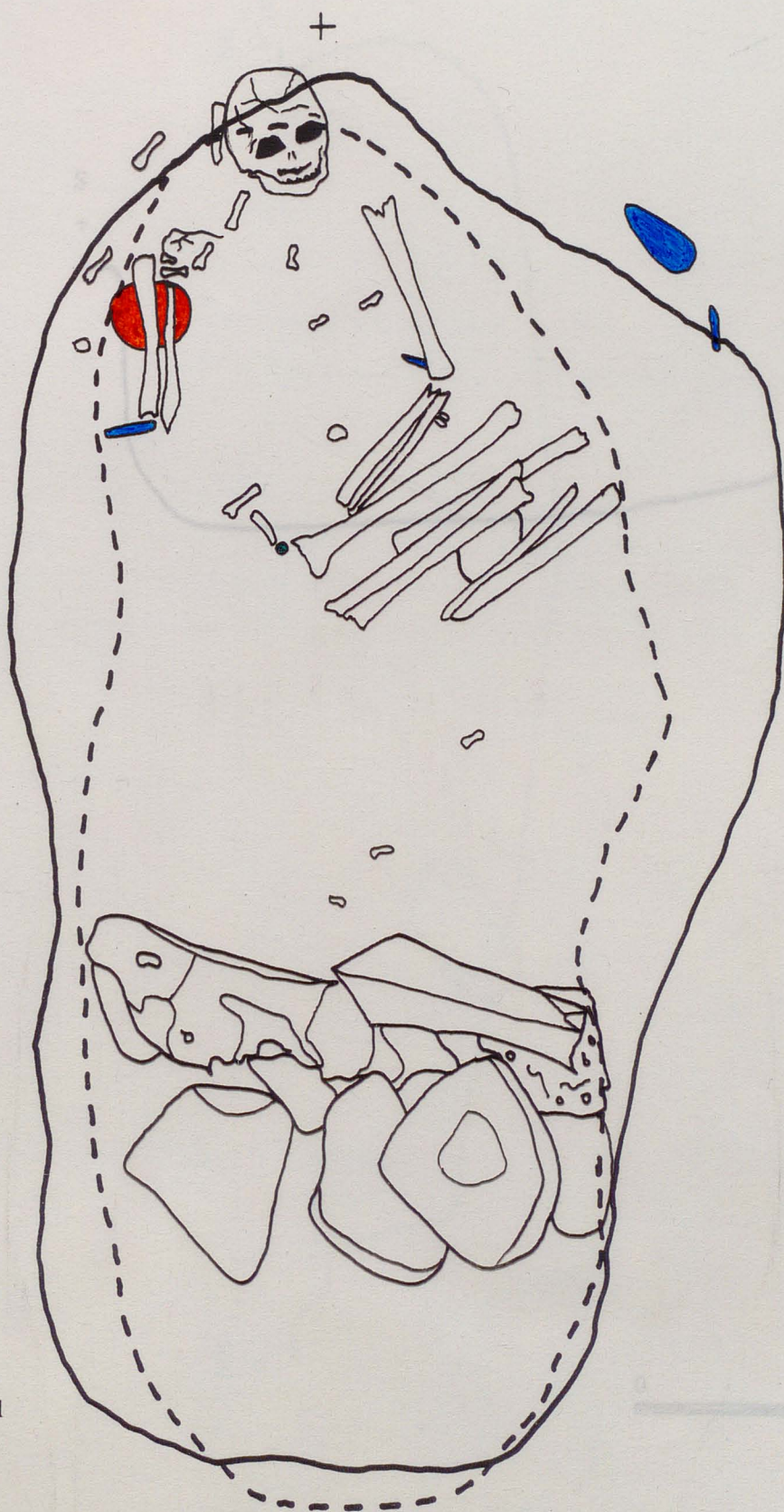

Punt Zero = 173.27 m.  
Nivell a 1 m.

	Informe	Vas	BN2G	BP	BPF	BNA	BNE	Dena	TOTAL
Ceràmica	10	1							11
Sílex			1	2	1				4
RMI						1			1
Serpentina							1		1
Calaita								1	1
<b>Total</b>	<b>10</b>	<b>1</b>	<b>1</b>	<b>2</b>	<b>1</b>	<b>1</b>	<b>1</b>	<b>1</b>	<b>18</b>

Fig.79.- Planta de l'enterrament M.11



— Planta inicial  
- - - Planta final

- |  |   |
|--|---|
|  Indústria lítica |  Indústria òssia     |
|  Ceràmica         |  Objectes d'ornament |

0 50 cm



0 50 cm.

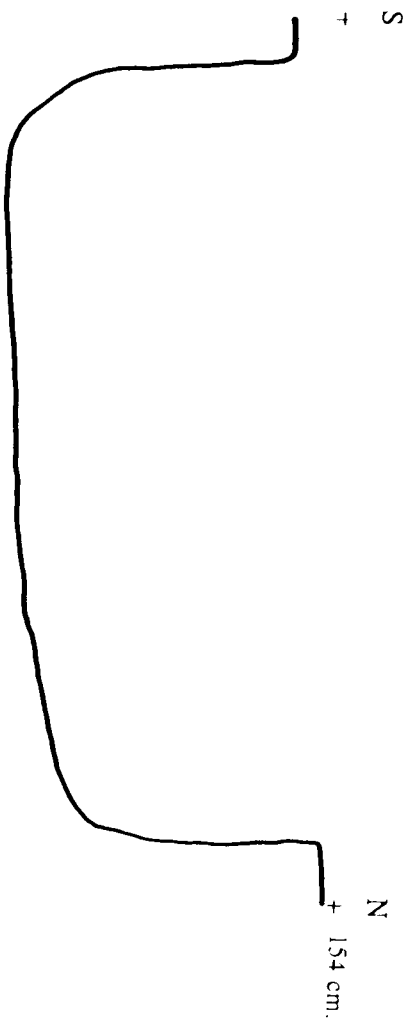

Fig. 80.- Secció N/S de l'enterrament M.11

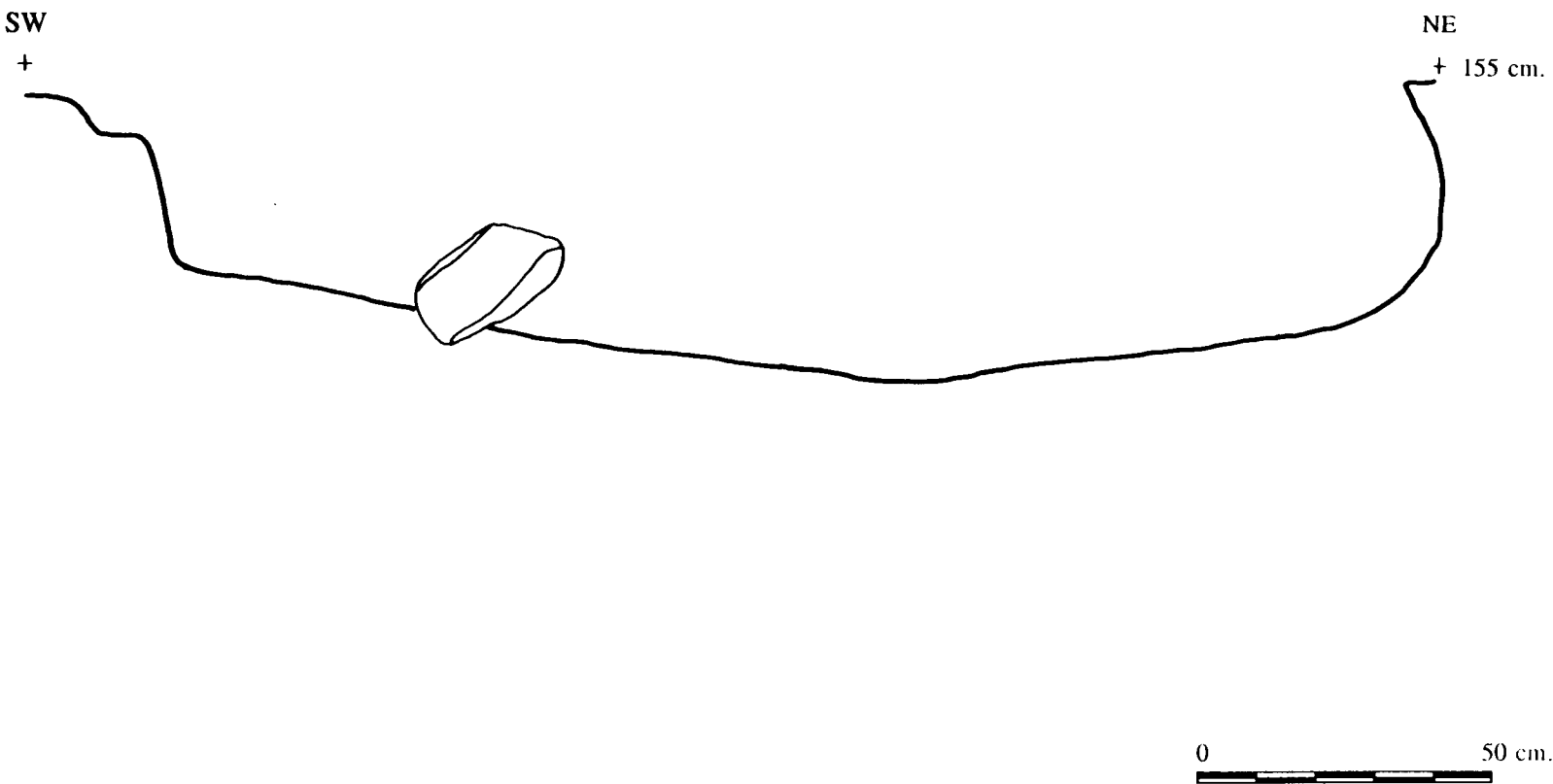

Fig. 81. - Secció NE/SW de l'enterrament M.11

**VI.4.8.- M-12**

Fossa de forma rodona d'unes dimensions reduïdes i fondària d'uns 12 cms. Està excavada en les argiles grogues amb carbonats i reomplerta d'un sediment argilós de color marró.

S'hi va trobar les restes d'unes costelles humanes força fragmentades i concrecionades. Aquestes van ser les úniques restes conservades que, degut al seu contexte, ens fa pensar amb un enterrament infantil. Junt a aquests ossos hi havia també una làmina de sílex i un fragment de ceràmica a mà amb nansa de llengüeta (Figs. 82 i 83).

ESTRUCTURA M.12

Punt Zero = 173.27 m.  
Nivell a 1 m.

	Aplica	BP	TOTAL
Ceràmica	1		1
Sílex		1	1
<b>Total</b>	<b>1</b>	<b>1</b>	<b>2</b>



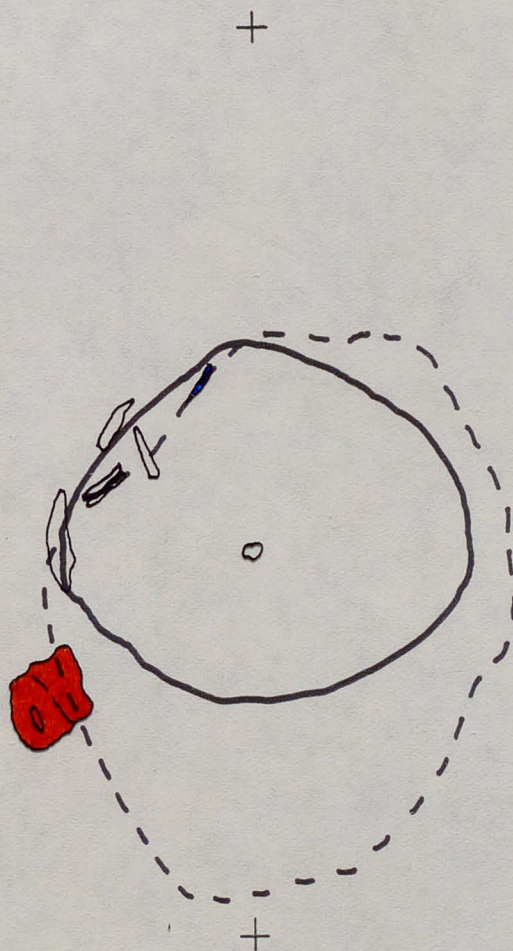

Fig. 82.- Planta de l'enterrament M.12





Planta inicial ———

Planta final - - - - -

 Indústria lítica

 Indústria òssia

 Ceràmica

 Objectes d'ornament

0  50 cm.

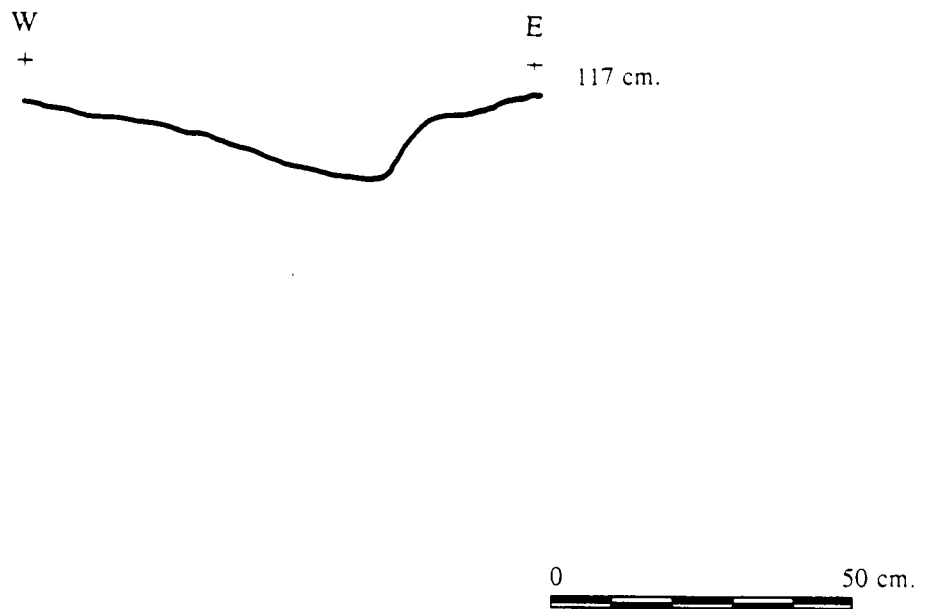
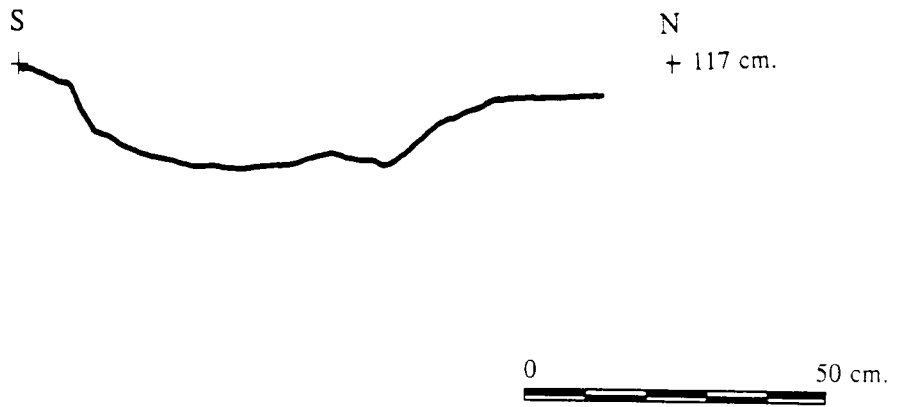

Fig. 83.- Seccions E/W i N/S de l'enterrament M.12

**VI.4.9.- M-14**

Estructura tallada per la màquina, conservant probablement només la meitat. Està excavada en les argiles grogues amb carbonats. Només s'hi ha conservat part d'un crani, probablement infantil, acompanyat de dues petxines i una lamina de sílex (Figs. 84 i 85).

ESTRUCTURA M.14

Punt Zero = 173.27 m.  
Nivell a 1 m.

	BP	Molusc	TOTAL
Sílex	1		1
Orgànic		1	1
<b>Total</b>	<b>1</b>	<b>1</b>	<b>2</b>



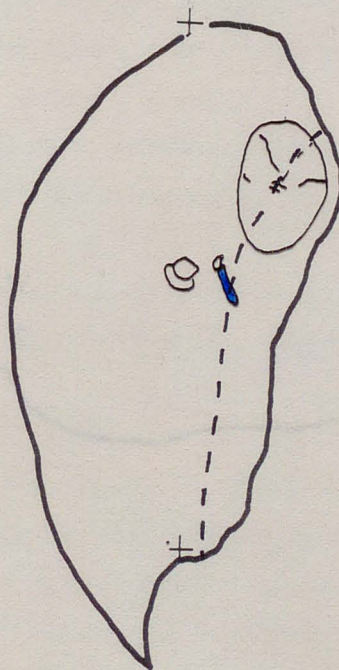

Fig. 84.- Planta de l'enterrament M.14



Planta inicial ———

Planta final - - - - -

 Indústria lítica

 Indústria òssia

 Ceràmica

 Objectes d'ornament



0  50 cm

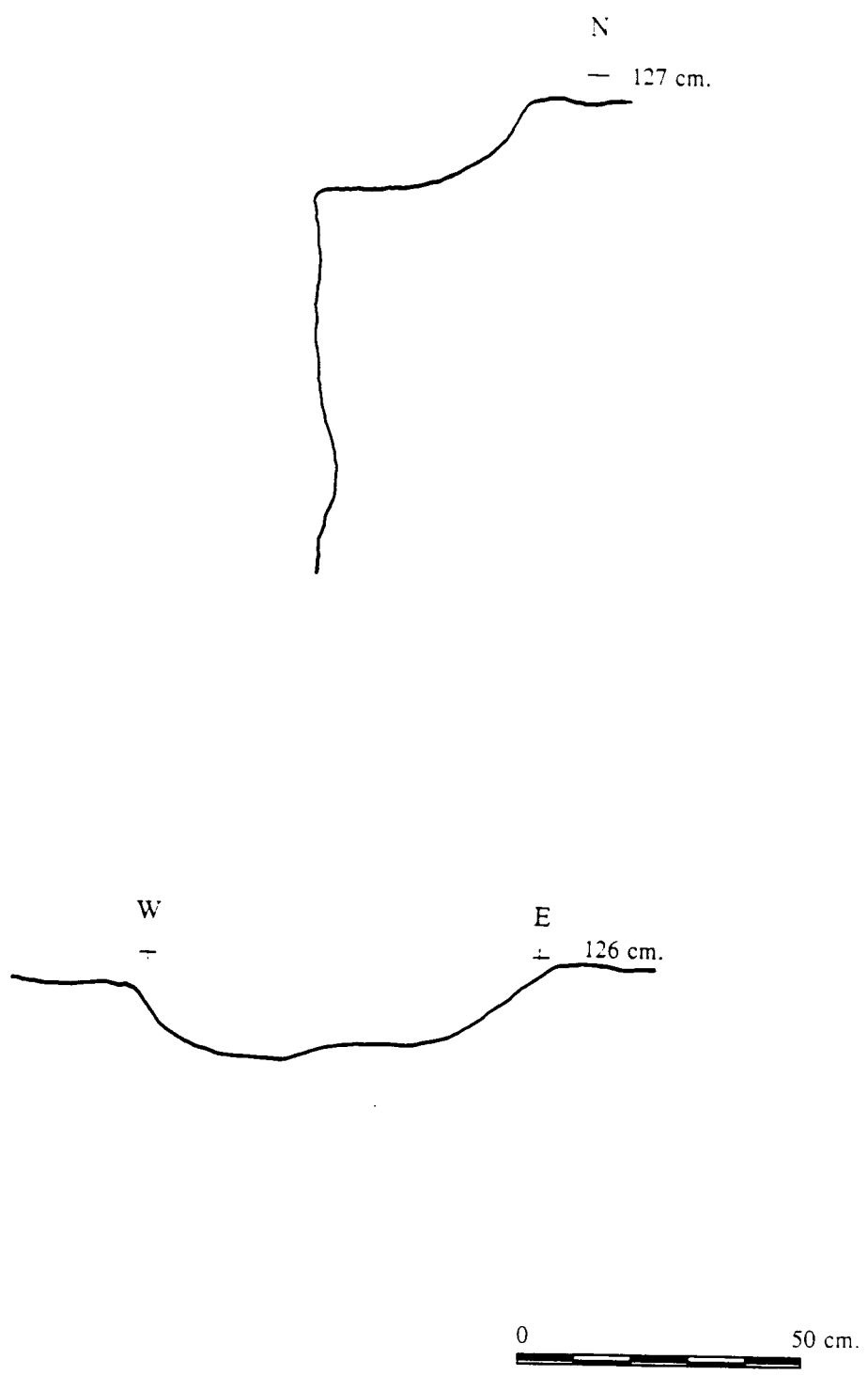

Fig. 85.- Seccions N/S i E/W de l'enterrament M.14

#### VI.4.10.- M-15

Estructura tallada per la màquina, però conservant pràcticament la seva totalitat. La seva forma sembla ser ovalada. Les parets baixen força verticals arribant a una profunditat d'uns 90 cm. Està excavada en les argiles grogues amb carbonats.

A la base d'aquesta estructura s'hi van trobar les restes òssies d'un cos humà, probablement un infant. No s'han conservat tots els ossos. El crani tombat endavant estava en molt mal estat, la mandíbula inferior estava desplaçada cap a un costat. Les costelles encara força ben conservades, ens demostren com el cos estava col·locat amb l'esquena a terra. Les escàpules no s'han conservat, malgrat això el braç esquerre sembla estar *in situ*, estant semiflexionat al costat del cos, cosa que no passarà amb el braç dret que sembla estar més mogut. Pel que fa a la pelvis tampoc s'ha conservat, només algun fragment aïllat. Les cames flexionades han basculat; la cama dreta cap al costat dret i l'esquerre cap al costat esquerre, quedant així obertes. No s'han conservat els peus.

A part d'aquestes restes òssies cal destacar un conjunt de ~~de~~ pedres col·locades intencionadament al costat del cos, sobretot en el cap, (potser falcant-lo), i en la part superior del costat esquerre.

Pel que fa a l'aixovar que l'acompanyava, hi havia un vas ceràmic sencer, làmines de sílex i una gran quantitat de denes de calaita (aproximadament unes 60 denes). Algunes d'aquestes es van trobar al final del braç dret probablement a la mà i la resta a sobre i sota de les costelles sobretot en el costat esquerre (Figs. 86 i 87).



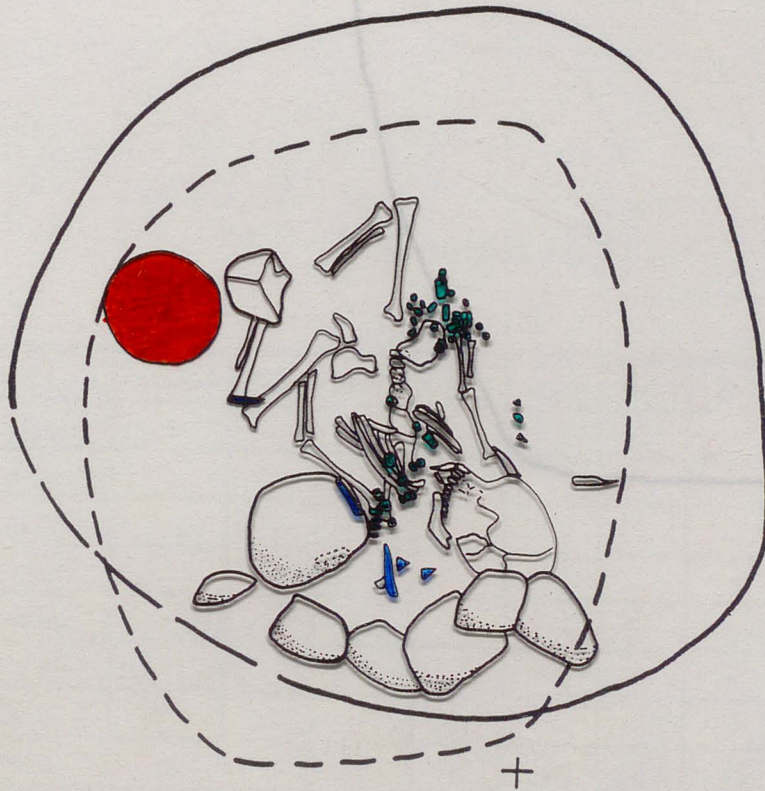

Fig. 86.- Planta de l'enterrament M.15



Planta inicial ———

Planta final - - - - -

 Indústria lítica

 Indústria òssia

 Ceràmica

 Objectes d'ornament



0  50 cm.

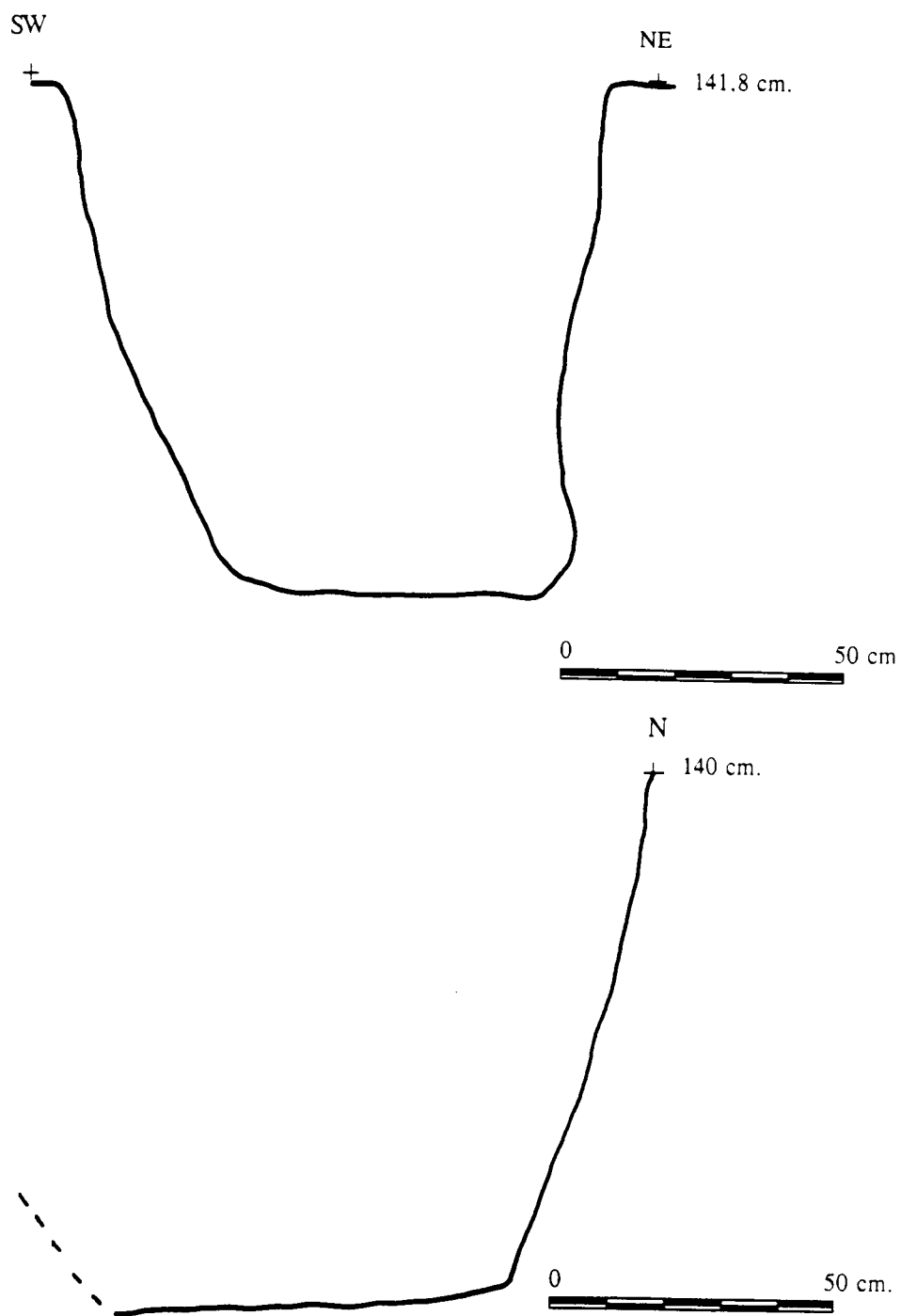

Fig. 87.- Seccions SW/NE de l'enterrament M.15

ESTRUCTURA M.15

Punt Zero = 173.27 m.  
Nivell a 1 m.

	Informe	Vas	Vora	BP	BN2G	BPF	BNA	Dena	TOTAL
Ceràmica	25	1	1						27
Sílex				5	1				6
Quars						1	1		2
Granit							3		3
Calcària							3		3
RMI							5		5
Calçaita								63	63
<b>Total</b>	<b>25</b>	<b>1</b>	<b>1</b>	<b>5</b>	<b>1</b>	<b>1</b>	<b>12</b>	<b>63</b>	<b>109</b>

## VI.4.11.- M-16

Fossa rodona excavada en les argiles grogues amb nòduls de carbonats.

A l'interior hi trobem un cos humà adult. Aquest es trobava en molt bon estat. Etava col·locat amb l'esquena plana a terra conservant força ossos en connexió. El cap estava caigut endavant però semblava estar encara en connexió amb la columna.

El tòrax estava cobert per pedres força planes. Un cop aixecades ens adonem com les costelles del costat dret estaven en perfecte estat mentres que les del costat esquerre estaven pràcticament totes elles fragmentades. Els braços estaven semiflexionats i els avantbraços estaven per sobre de la pelvis. De les mans només es conservaven algunes falanges permetent-nos veure la posició de la mà (fase palmar).

Pel que fa a la pelvis semblava ser el que estava en més mal estat ja que només s'en conservava algun fragment.

Les cames estaven semiflexionades i tombades cal al costat dret.

D'aixovar només s'hi va trobar una làmina de sílex.

El cos estava orientat de E-W (Figs. 88 i 89).

## ESTRUCTURA M.16

Punt Zero = 173.27 m.  
Nivell a 1 m.

	Informe	BP	BNA	TOTAL
Ceràmica	10			10
Sílex		1		1
Conglome			2	2
Sorrencia			1	1
Quars			1	1
RMI			4	4
<b>Total</b>	<b>10</b>	<b>1</b>	<b>8</b>	<b>19</b>



Fig. 88.- Planta de l'enterrament M.16

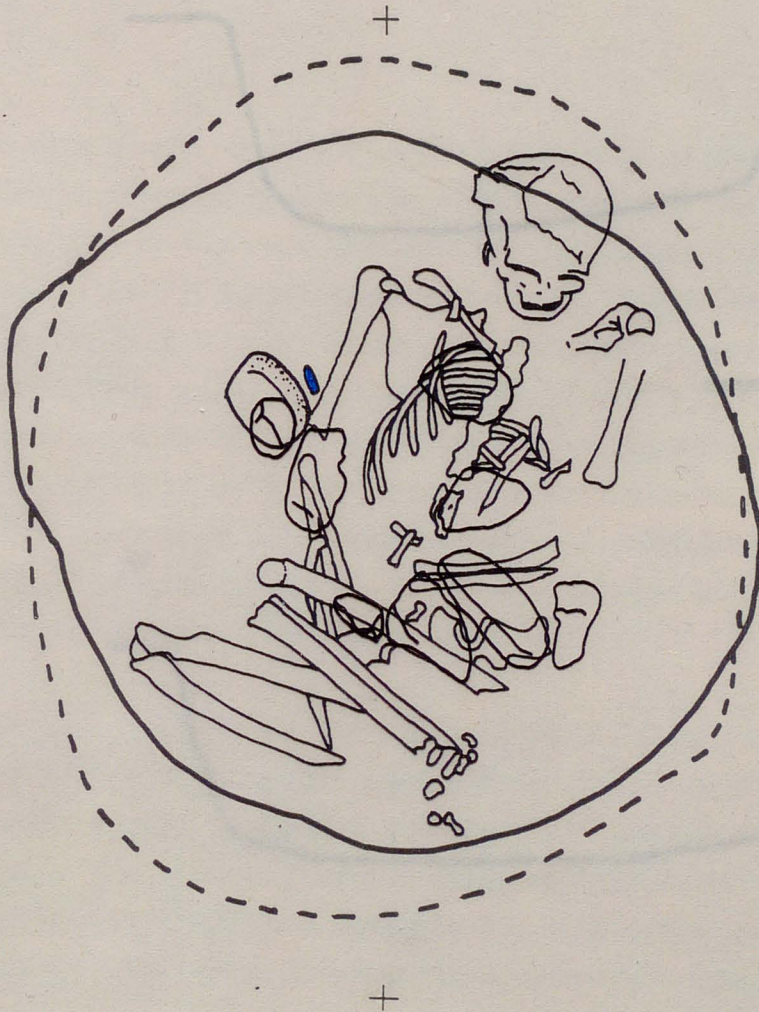

Planta inicial ———

Planta final - - - - -



Indústria lítica



Indústria òssia



Ceràmica



Objectes d'ornament



0

50 cm.





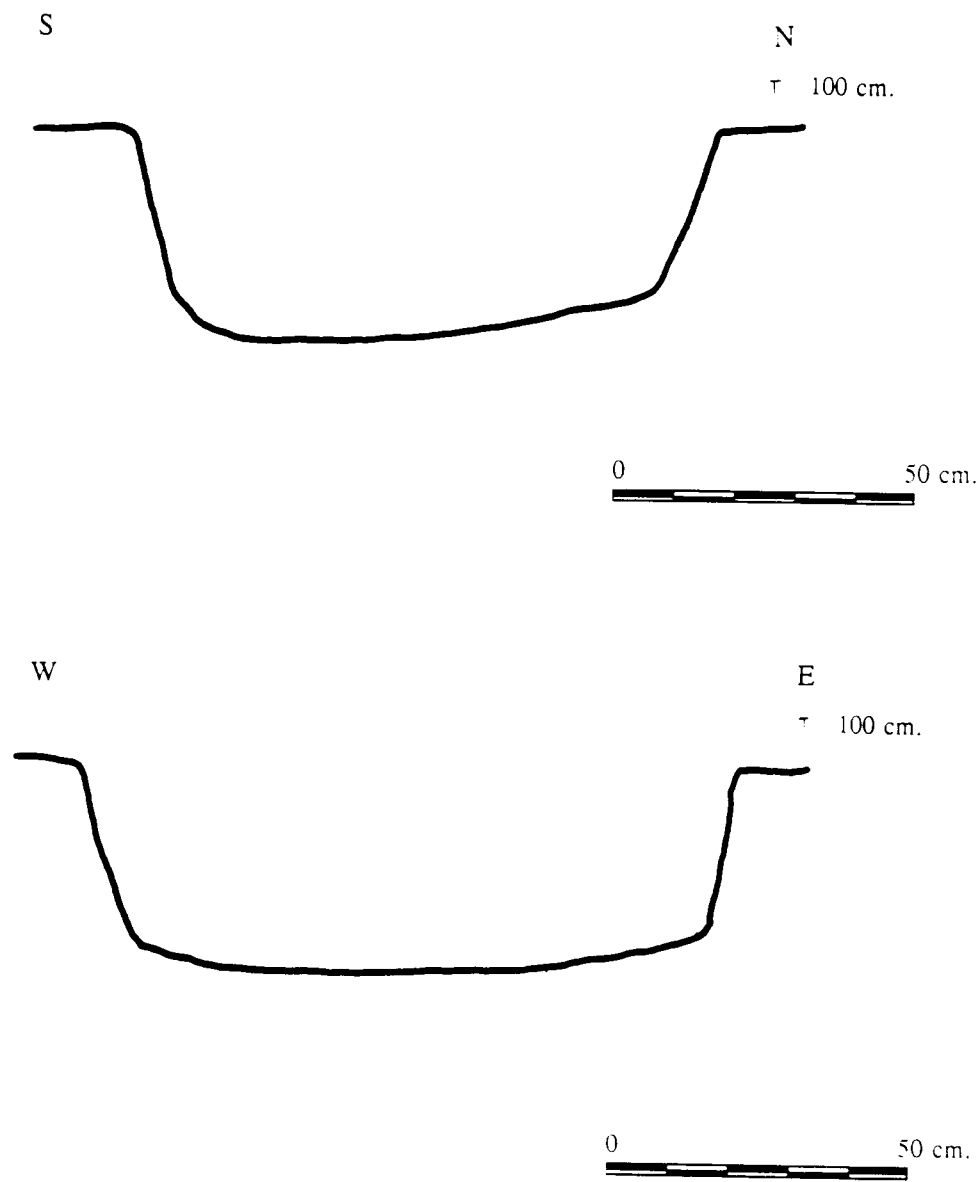

Fig. 89.- Seccions N/s i E/W de l'enterrament M.16

## VII.- CARRER 8

En aquest carrer s'havia marcat una possible estructura per la presència de material en el sediment. Després d'una neteja superficial es va comprovar la presència d'abundant material arqueològic, però no d'un canvi sedimentològic clar. Davant d'això, es va decidir quadricular la zona per situar el material tridimensionalment. Paral·lelament a l'excavació es va realitzar un sondeig d'un metre quadrat una mica més al nord de la zona quadriculada per veure si es podia apreciar algun canvi en el sediment. El sondeig va resultar negatiu no apareixent cap canvi sedimentològic ni cap resta de material arqueològic. Després d'una primera passada a la zona es va poder apreciar com el material quedava reduït ràpidament a una concentració que ocupava els quatre quadres centrals. La tendència del material durant l'excavació va ser la de reduint-se cap el centre a mida que s'anava baixant, disminuint l'àrea de dispersió del material a mida que augmentava la profunditat.

Sembla ser que estaríem davant d'una fossa de planta possiblement circular d'un diàmetre una mica inferior als dos metres i una potència aproximada d'uns 40 cms. El sediment del que seria l'interior i l' exterior de l'estructura està compost per argiles vermell-marronoses compactes. Un cop el material arqueològic va desaparèixer es van fer varies passades localitzant en un nivell inferior la capa de tortorà. El fet de que l'estructura estigués excavada a les argiles i no al tortorà explica el que no es poguessin localitzar els seus límits.

Del material aparegut cal destacar la presència d'abundants fragments ceràmics que presentaven nanses de cinta petites, aplicacions (mugrons i llengüetes), el fons d'una ceràmica gruixuda i de pasta grollera que pot correspondre a un recipient de grans dimensions i varies vores i fragments informes de ceràmica de parets primes i ben acabades, de color negre, però mal cuites. L'instrumental lític és escàs, mentre que és molt elevat el nombre de pedres a l'interior d'aquesta estructura.

Pel material aparegut, sobretot les ceràmiques, podem pensar que aquesta estructura es situaria dins del període Neolític Final.

### VIII.- CARRER 9

En aquest carrer s'havia marcat durant el seguiment de les màquines excavadores l'existència de cinc possibles estructures per la presència d'alguna pedra en superfície. Com en tots els casos es va procedir a una neteja superficial per tal de cercar els límits sedimentològics de les possibles fosses. Aquests no van aparèixer, constatant només la presència d'una dispersió de material molt rodat sense cap distribució aparent i ocupant una àmplia zona del carrer. Es va decidir muntar una quadrícula d'uns 25 metres quadrats que abarcava les estructures 9.1, 9.2 i 9.3.

Al excavar aquesta zona es va comprovar que no existia cap estructura, la majoria dels quadres van ésser estèrils i els pocs que van donar material ho van fer en molt poca quantitat trobant-se sempre aquest molt rodat. La presència d'aquest petit nombre de material sembla correspondre a una aportació natural fruit d'un procés d'erosió i sedimentació produït dins del mateix del jaciment. Aquesta hipòtesi es veuria reforçada per la presència de pedres i ceràmiques rodades formant línies pràcticament rectes i paral·leles.

Les altres dues estructures també van ser excavades sistemàticament resultant totalment estèrils en quant a material arqueològic fa referència i tampoc es va trobar cap tipus de canvi sedimentològic que ens indiqués que ens trobàvem davant d'una estructura.

Com a comprovació final es va fer un resseguiment amb la màquina excavadora donant un resultat negatiu.

## IX.- LLAR 7.1

En un costat del carrer 7 va aparèixer una llar totalment aïllada. Aquesta estava excavada a les argiles vermelles amb nòduls de carbonat i reomplerta de pedres i terra rubefactada, així com carbons. Un cop delimitada es va dibuixar en planta i es va procedir a la seva excavació dividint-la en quarts i rebaixant-los mitjançant "aixecaments" que responien a diferents nivells de pedres i a canvis interns del sediment. Així el primer aixecament correspon a les cotes de 113 i 117 cms. amb moltes pedres, l'aixecament 2 presentava un menor nombre de pedres però una major concentració de carbons. L'últim aixecament, 3, no presentava pedres però sí carbons i continuava la terra cremada.

La tipologia de la fossa és circular amb una secció en cubeta reomplerta de pedres de gran tamany (més de 10 cms). Algunes presentaven esclats tèrmics, realitzant-se fins i tot remuntatges en el mateix camp. En quan al material arqueològic només va aparèixer un petit esclat de sílex, però que resulta difícil determinar la seva cronologia. A més es va obrir els voltants per veure si estava relacionat amb un sòl d'ocupació. El resultat va ser negatiu.

D'aquesta llar es van recollir mostres de terra per una anàlisi de greixos i mostres de micromorfologia per determinar si existia un o varis moments d'utilització de la llar (Figs. 90, 91 i 92).

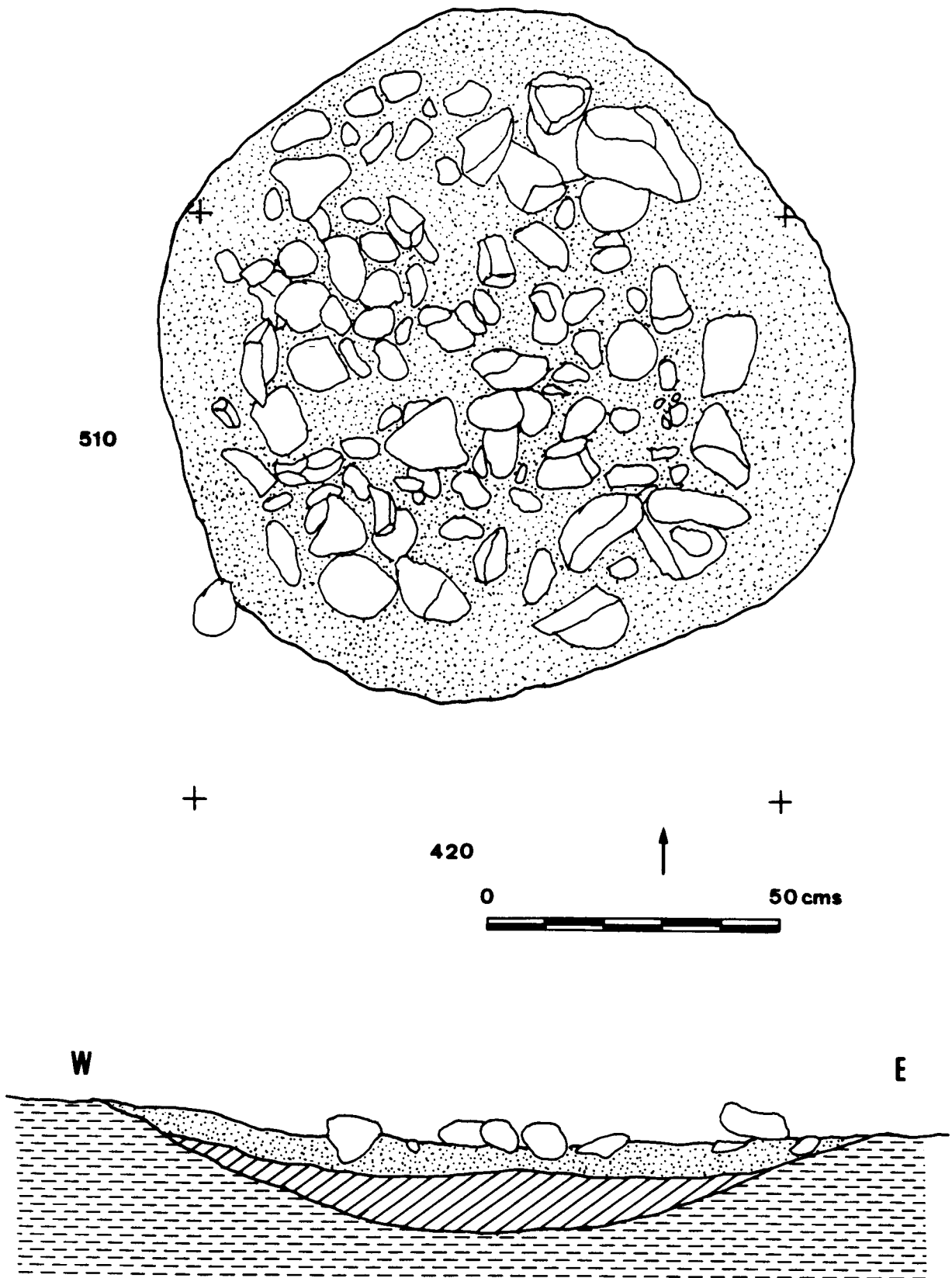
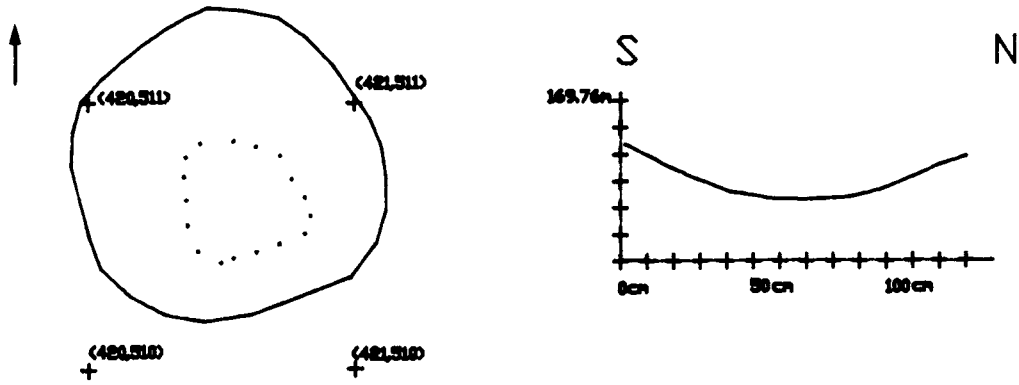

Fig. 90.- Planta i secció de la llar 7.1

# ESTRUCTURA 7.1



## ESTRUCTURA 7.1

Punt Zero = 185.21 m.  
Nivell a 1.80 m.

Talles	12	13	14	TOTAL
Calcària	5	2		7
Altres	Esquist 9 Granit	Esquist 3 Granit		12
Quars	15	7	1	23
RMI	34	12		46
Sílex	1			1
Sorrencia	1			1
<b>Total</b>	<b>65</b>	<b>24</b>	<b>1</b>	<b>90</b>

Fig. 91.- Planta i secció de la llar 7-1.

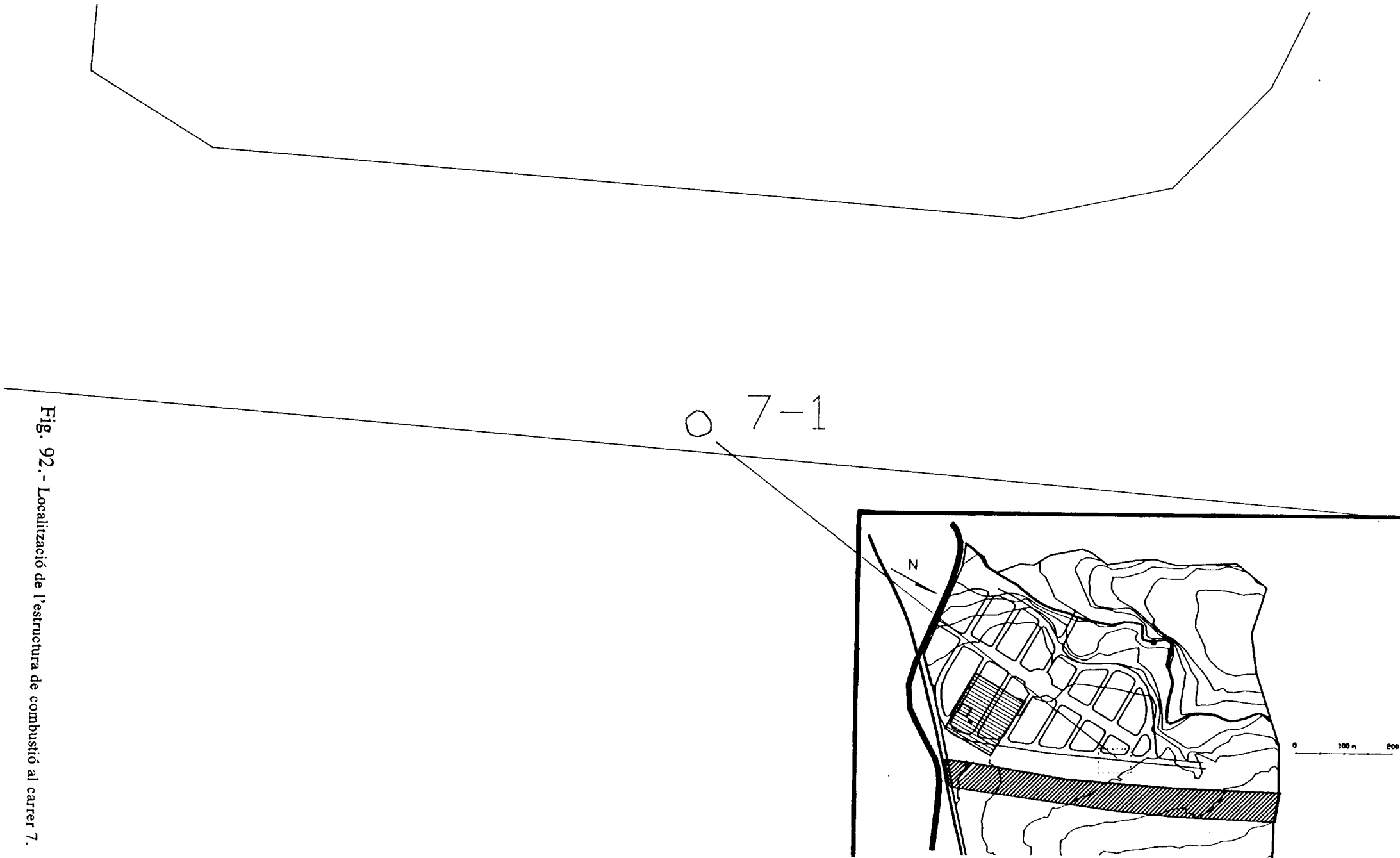

Fig. 92.- Localització de l'estructura de combustió al carrer 7.

## **XI.- MOSTRES RECOLLIDES**

### **XI.1.- MICROMORFOLOGIA I MOSTRES DE TERRA.**

A part de les mostres de terra guardades sistemàticament per talles i sectors de les fosses d'emmagatzematge per ésser tractades per recuperar les macrorestes/restes vegetals, s'han recollit dos tipus més de mostres:

- **mostres de micromorfologia.** Per aquestes s'utilitzaven caixetes d'alumini de 15 cms de llargada per 5 cms d'espessor que es clavaven al sòl per després ésser coordinades tridimensionalment, indicant la part superior, la inferior i el nord. La finalitat de la recollida d'aquestes mostres és diversa: constatar si la composició del sediment està en situació primària o ha estat remogut, comprovar terres rubefactades i diferents nivells de cremació, determinar l'existència d'alteracions químiques, bé sigui per descomposició de matèries orgàniques o d'altres tipus.
- **mostres de terres.** S'han recollit en bosses de 2 kgs. diferents tipus de sediments que presentaven característiques diferenciadores com pot ésser la presència de carbons o cendres, indicis de rubefacció.... Les mostres pertanyen tant a fosses com a la cabana. Les primeres han estat recollides per sector i talla, les segones per quadre i talla. Aquestes acostumen a estar associades a estructures internes de la cabana.



L'inventari de les mostres de terra és el següent:

-Com a cas especial hem d'afegir la recollida de una sèrie de pedres associades a una concentració de carbons i possiblement terra rubefactada de l'interior de la cabana, per una anàlisi dels greixos animals o vegetals que puguin haver absorbit. Per la seva conservació van ésser guardades amb paper d'alumini sense que es produís contacte manual amb elles.

MOSTRES DE TERRES	
QUADRE	NUM. DE MOSTRES
263,555 263,556	1
264,559 264,560	2 (1 Sector E / 1Sector W)
265,559	1 (Talla 19)
265,560	2
266,557	1
266,558	2

MOSTRES DE TERRES	
ESTRUCTURES	NUM. DE MOSTRES
7.1.	1 Sector E / 1 Sector W
7.4.	4
7.3.	2 Sector E / 2 Sector W
10.4.	1

MOSTRES DE MICROMORFOLOGIA	
QUADRE	NUM. DE MOSTRES
263,556	1
264,555	1
265,557	1
265,559	1
265,560	1
266,558	1

MOSTRES DE MICROMORFOLOGIA	
ESTRUCTURES	NUM. DE MOSTRES
M 7	2
7.1	1

## **XI.2.- PALEOCARPOLOGIA**

El jaciment arqueològic de la Bòbila Madurell es presenta en un medi no humit cosa que farà que la conservació de les macrorestes/restes vegetals necessiti del fenòmen de la carbonització.

La mayoría de los yacimientos se ubican en un sedimento no húmedo, y la carbonización puede resultar por factores naturales: accidentes, incendios,... pero sobre todo es un fenómeno producido por la manipulación humana.

### **XI.2.1.- MOSTREIG**

En el procés d'excavació s'han estat guardant diferents mostres de sediment pel seu posterior tractament. La tria de sediment ha seguit diferents criteris segons el tipus d'estructura:

- Cabana: es va triar el sediment de zones puntuals susceptibles de contenir macrorestes/vegetals. Les mostres triades encara no han estat tractades.
- Fosses: s'ha estat recollint una mostra (aproximadament 10 Kgs) per talla i sector en totes les estructures excepte en els enterraments. A les sepultures s'ha comprovat la talla on apareixia el mort, tractant amb especial atenció aquest sediment.

## XI.2.2.- METODOLOGIA

En aquesta campanya s'estan utilitzant dos sistemes per l'obtenció de macrorestes / restes vegetals: flotació manual simple i tractament de sediment sota l'aigua.

- flotació manual simple: el tractament es provoca de manera manual una remoguda en l'interior del recipient durant períodes intermitents i controlats. Després d'això, les restes existents que apareixen flotant són recollides amb un colador i seleccionades o rebutjades.

Es tracta de contrastar ambdós mètodes de manera sistemàtica mitjançant processos paral·lels. Això ens permetrà saber la capacitat de dissolució de cada un dels productes i comparar-los.

Tant pel "Calgonit" com per el (NaPO<sub>3</sub>)<sub>6</sub> s'estan escollint 10 Kgs de sediment per 25,5 lts d'aigua. La quantitat dels productes utilitzada es 0,048 Kgs de "Calgonit" i 0,021 Kgs de (NaPO<sub>3</sub>)<sub>6</sub>.

Mentre que el (NaPO<sub>3</sub>)<sub>6</sub> es dissol a l'aigua abans del sediment, el "Calgonit" es llença a posteriori.

El temps de repòs pel "Calgonit " és de 2,30 hores, amb remogudes - observacions cada mitja hora. Pel (NaPO<sub>3</sub>)<sub>6</sub> s'està mitja hora, dividida en dos fraccions de 15 minuts. Aquestes previsions inicials no han impedit disminuir o augmentar aquests marges segons fos necessari.

Amb el sistema de flotació s'ha tractat únicament el sector Est de les estructures, deixant l'Oest pel tractament sota aigua.

- Tractament del sediment sota l'aigua: abans del rentat del sediment de cada talla s'ha guardat una mostra per posteriors estudis de C13 i altres.

En aquest sistema hem utilitzat una columna de malles. Si bé la norma usual es fer servir tres nivells, nosaltres n'hem utilitzat dos.

La malla dels garbells utilitzats és de 5 milimetres i 0,5 milimetres respectivament.

Els residus procedents del rentat es dipositen sobre paper assecant pel seu assecat.

Han estat observats únicament els de la malla superior quedant els de la inferior emmagatzemats en bosses en espera del seu futur estudi.

### **XI.2.3.- PRIMERS RESULTATS**

Pel sistema de flotació manual simple han estat tractades diferents talles de 32 estructures el que suposa un volum de 685 Kgs. de sediment. D'aquestes 32 estructures només 8 han aportat macrorestes/restes vegetals, apareixent sempre aquestes (a excepció d'una llavor) carbonitzades.

Aquestes estructures han estat, precisament les més riques en materia orgànica i en alguns casos ha estat necessari deixar més temps en repòs el sediment. A major volum de macrorestes/restes vegetals ha estat convenient un major temps de repòs.

Si bé podem afirmar l'efectivitat d'ambdós productes cal assenyalar que amb el (NaPO<sub>3</sub>)<sub>6</sub> es redueix el temps invertit. Això suposa una disminució de treball encara que eleva el cost del procés a l'ésser aquest producte més car que el "Calgonit".

Mitjançant el sistema de tractament del sediment sota l'aigua han estat tractades diferents talles de 30 estructures. Això suposa un volum de 1.070 Kgs de sediment. El nombre de macrorestes/restes vegetals el sabrem quan s'ha analitzin els residus, podent així comparar els resultats d'aquest sistema amb el de flotació manual simple.

ESTRUCTURA	TALLA	SECTOR	Nº LLAVORS	Nº FRAGMENTES	Nº CAPSULES
M-11	18	E	1	-	-
I-6	10	E	1	7	-
I-7	12	E	-	5	-
7-3	8	E	52	143	-
7-3	10	E	9	17	-
7-4	10	W	1	-	-
7-4	11	E	1	2	-
7-4	12	E	2	-	-
7-4	13	E	3	5	-
7-5	8	E	-	-	8
<b>TOTAL</b>	-	-	<b>70</b>	<b>179</b>	<b>8</b>

### XI.3.- CARBONS

La recollida de mostres de carbons s'ha fet seguint tres mètodes:

- Numerant-los i coordinant-los utilitzant el sistema de quadrícula ( com qualsevol altre objecte) a l'interior de la estructura d'habitació.
- recollint-los per sector i talla a l'interior de les fosses.
- recollint-los per quadre i talla a l'interior de la estructura d'habitació. Aquests acostumen a forma part d'estructures internes bé siguin llars, fosses, ....

Cal diferenciar dos tipus de mostres de carbons: les recollides per fer estudis d'antracologia i les recollides per datacions de C14.

Un cop arriben les mostres al laboratori els carbons es deixen assecar en un lloc airejat i amb poca humitat amb cura de no ésser contaminats. Són emmagatzemats depenent del tamany dins de pots de diapositives o bé amb paper d'alumini.

MOSTRES PER DATAR: Estructura d'habitació		
264,555	Talla 27	
266,555 267,555	Talla 19	Llar H3.1.
266,556 267,556	Talla 19	Llar H3.1.
267,555	Talla 20	Llar H3.1
267,555	Núm. 227 i 229	Llar H3.1.
267,556	Talla 19	Llar H3.1.

MOSTRES PER DATAR: Estructures d'Emmagatzematge		
7.1.	Aixecament 1	Sector Oest
7.3.	Talla 8	Sector Est

ESTRUCTURES	SECTOR EST	SECTOR OEST
10-5	T 15/ T16	T 15/ T16
10-4	SECTOR NORD:T16/T18 SECTOR NE: T17	SECTOR W:T15 SECTOR NW: T15,T16 SECTOR SW: T15
7-1	AIX 2/ AIX 3	SECTOR NW AIX 2
10-3	T20	
7-2	T6	T7 / T8
7-3	T10/ T7	T8/ T10/ T7
7-6	T5	
11-1	T12	
I-6		T10
I-8	T12	
I-9	T15	T15
J-3	T15/T16/T18/T13	
J-1	T6/ T10	T14



QUADRE	COORDENATS	TALLES
261,558		
262,554		28
262,556	82	28
262,558	186	19
262,559	82 (H-4)	13
263,555		28
263,556	201,14	23,22
263,557		31,27
263,558		17
263,559	185,181,162	14
264,554	50,45	
264,555	545,545,577,515,528,620,654,550	21,24,25,25,27,26
264,556	95,340,351,292,362,372,352,358	18,22,19,20,23
264,557	121,111,97,96	T. 19
264,558		
264,559		14,21
264,560		15
265,555	235,234,248,236,188,187,118,119	20
265,556	201,14	22,23
265,557	162,140,80	20
265,558	69,71	T. 15,18,21 (FOSSA NW)
265,559	29 (H3),45,43,35,38	14,16,18
266,555	92	19,18
266,556	98,68,50,83	17
266,557	264,72	17,18
266,558	114,233,138,126	22 (SE),21,20
266,559	74	18
267,555	190,229	18,19
267,556	277,280	19,18

267,557		16,18
267,558	105,104,98,70	19
268,555		
268,557		17
LLAR H-5		20 (NE)/ 20 (SW)
H-7		19

## XI.4.- MALACOLOGIA

A part dels mol·luscs marins trobats a les fosses i inventariats junt amb la resta de materials d'aquestes (veure llistat del material de les fosses) s'han recollit mostres de cargols que formaven part del sediment intern de la cabana (pràcticament tots pertanyen al nivell H-2). Aquestes mostres han estat guardades per quadre i talla.

QUADRE	TALLES
262-558	16-19-20 (H-4)
262-559	12-13-14
263-555	18-19-20
263-556	22-20
263-557	18
263-558	18
263-559	15-16
264-555	18-21-22
264-556	16-19-21-23
264-557	20
264-558	15
264-559	14-15-17
264-560	14
265-556	18-19
265-558	20
265-559	14
266-559	20
267-557	16
267-555	16-19



**MEMORIA  
MAS DURAN  
SANT QUIRZE DEL VALLÈS**

**VOLUM II**

**COL.LABORADORS..... Vicente LOPEZ  
Jordi CASADEVALL  
Xavier CARLÚS  
Jesus BERMUDEZ  
Meritxell SURINYAC  
Albert MONTULL  
Juan Fº GIBAJA  
Joaquin VILLAFRUELA  
Josep DURAN  
Angel PEREZ  
Arcadi VILA**

***DEPARTAMENT D' HISTORIA de les SOCIETATS  
PRE-CAPITALISTES i ANTROPOLOGIA SOCIAL***

**UNIVERSITAT AUTÒNOMA de BARCELONA**

**MEMÒRIA D'EXCAVACIÓ DELS TREBALLS DUTS A TERME  
ENTRE EL  
15 D'ABRIL AL 15 DE DESEMBRE DE 1991**

**BELLATERRA, FEBRER 1992**



## **INDEX**

**VOLUM II**

**ANNEX I.- LLIBRE D'ESTILL**

**ANNEX II.- SECCIONS DE L'ESTRUCTURA D'HABITACIO C-11**

**ANNEX IIIa.- INVENTARI DE L'ESTRUCTURA D'HABITACIO C-11**

**ANNEX IIIb.- INVENTARI DELS ENTERRAMENTS I DE LES ESTRUCTURES  
DE EMMAGATZEMATGE**



## ANNEX I

LLIBRE D'ESTIL  
METODOLOGIA EMPREDA

---

## 1.- INSTAL·LACIO DE LA QUADRICULA

---

S'orientarà sempre vers el Nord. Quan sigui possible vers el Nord Geogràfic, i quan aquest sigui de difícil o confosa localització ràpida, vers un Nord Teòric.

La nomenclatura de la quadrícula cartesiana vindrà definida per la combinació de dos números.

Respecte el Nord que orienti la quadrícula, l'eix horitzontal (X) serà numerat, amb ordre creixent d'esquerra a dreta; i el vertical (Y) serà identificat també amb números ordenats de baix a dalt. Es pot veure un esquema d'aquesta ordenació en la figura següent :

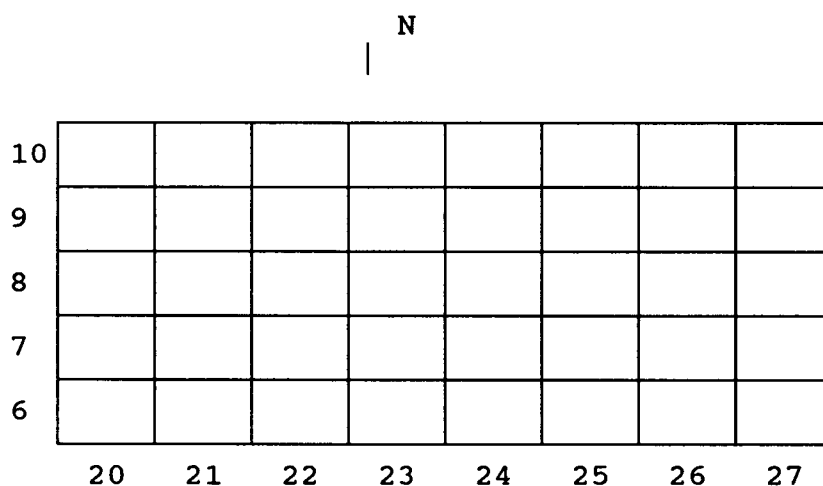

Es recomana no iniciar l'ordenació numèrica pel 1 sinó per una xifra superior. L'objectiu d'això és deixar marge per a futures ampliacions de la zona d'excavació tant pel marge Oest de la quadrícula com per la seva banda Sur.

---

## 2.- AIXECAMENT DEL REGISTRE ARQUEOLÒGIC

---

El procés d'aixecament del registre arqueològic es realitzarà en tres fases:

- a) Els carbons i ocres es coordinaran només quan siguin **majors de 3 cm.**, mentre que els menors d'aquesta mida es recolliran, per quadrats, en pots de fotografia **convenientment identificats**.
- b) Per aixecar les plantes, es posarà, a sobre del quadre, un marc d'alumini d'un metre quadrat subdividit en subquadrats de 10x10 cm.
- c) Es dibuixarà, a una planta a escala 1:10, un punt o un eix en cas de que l'objecte tingui una orientació determinada, en el qual quedin representades tant les **coordenades** de l'objecte com la seva **orientació** i mesures aproximades. En cas d'objectes de gran tamany, es dibuixarà, d'una manera esquemàtica i ràpida, el contorn dels mateixos. A la planta en qüestió es posarà el **nom del quadre** així com la indicació del **Nord**. Finalment, es posarà, al costat de la línia de l'objecte, el **nº de registre** corresponent a cada un d'ells.
- d) Es complimentarà el full d'excavació segons les normes exposades al capítol següent.
- e) Una vegada agafades totes les dades de l'objecte, i **només una vegada fet**, es podrà aixecar l'objecte, el qual s'embolicarà en un tros de paper higiènic al qual constaran, escrites amb **bolígraf**, les següents dades:
  - el quadre
  - la unitat arqueològica
  - el nº de registre de l'objecte
- f) Les acumulacions de carbons o d'ocres es dibuixaran a una planta a escala 1:10.



### 3.- COMPLIMENTACIO DEL FULL D'EXCAVACIO

En ell s'anotaran les dades dels objectes recuperats en l'excavació, i segueix el següent model :

Nº	X/D	Y/α	Z	ORIENTACIO	PENDENT	MATERIA	OBJECTE	L	A	E	ALT/OBS
----	-----	-----	---	------------	---------	---------	---------	---	---	---	---------

Per complimentar-lo correctament caldrà tenir en compte els següents criteris per a cada variable:

- **Nº** : Nº d'inventari de l'objecte recuperat. Aquesta numeració serà independent per cada quadre i seguirà un ordre correlatiu a partir de l'1. Serà el mateix número que s'hagi posat a la planta.
- **X / D** : Aquest camp no es complimentarà doncs les coordenades de l'objecte ja figuren a la planta del quadre. Posteriorment, al laboratori, es complimentarà aquest camp posant la **X** en centímetres.
- **Y / α** : Aquest camp no es complimentarà doncs les coordenades de l'objecte ja figuren a la planta del quadre. Posteriorment, al laboratori, es complimentarà aquest camp posant la **Y** en centímetres.
- **Z** : Valor en centímetres de la profunditat que separa el punt zero de l'excavació de l'objecte a coordinar.

En el cas de que, per les dimensions de l'objecte, s'hagin de prendre dues zetes (una superior i una inferior), es dividirà aquest camp en dues zones per mitjà d'una diagonal i es col·locarà la zeta més alta (el nº més petit) a la part esquerra, mentre que la zeta més baixa (el nº més gran), a la part dreta.

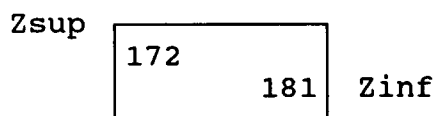

- **ORIENTACIO** : L'orientació de l'objecte va referida al Nord de l'excavació, i pot ser :

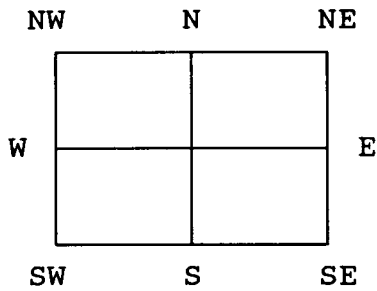

Orientació	Abreviació
Nord-Sud	N-S
Est-Oest	E-W
NordOest-SudEst	NW-SE
NordEst-SudOest	NE-SW

- **PENDENT** : El pendent de l'objecte va referit al Nord de l'excavació, i pot ser :

Exemple : Pendent = Nord

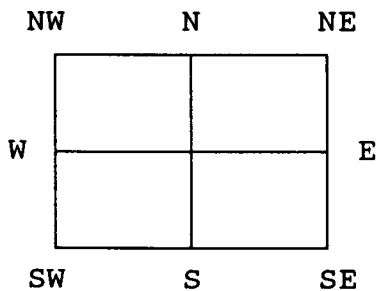

Pendent	Abreviació
Pla	P
Vertical	V
Nord	N
Sud	S
Est	E
Oest	W
Nord-Est	N-E
Nord-Oest	N-W
Sud-Est	S-E
Sud-Oest	S-W

---

- **MATERIA** : La materia primera de l'objecte pot ser :

LITICA	Abreviació
Calaita	CALAITA
Calcària	CALCARIA
Conglomerat	CONGLOME
Corneana	CORNEANA
Esteatita	ESTEATIT
Granit	GRANIT
Jasp	JASP
Lidita	LIDITA
Quars	QUARS
Quarsita	QUARSITA
Pissarra	PISSARRA
Serpentina	SERPENTI
Sílex	SÍLEX
Sílex melat	SILEXM
Sorrenca	SORRENCA
Ocre	OCRE

Altres	Abreviació
Os	OS
Orgànic	ORGANIC
Ceràmica	CERAMICA
Indeterminada	INDET
Tovot	TOVOT
Dena	DENA

---

**OBJECTE** : Els Objectes Lítics documentats poden ser :

Objectes Lítics	Abreviació
Base Natural	BNA
Base Negativa	BNE
Base Positiva	BP
Base Positiva de Segona Generació	BP2G
Base Positiva Fragmentada	BPF
Base Positiva Informe	BPI
Base Negativa de Primera Generació	BN1G
Base Negativa de Segona Generació	BN2G

Els Objectes Ossis documentats poden ser :

Objectes Ossis	Abreviació
Determinable	DET
Indeterminable	INDET
Treballat	BN2G

Els Objectes Orgànics documentats poden ser :

Objectes Orgànics	Abreviació
Carbó	CARBO
Coprolit	COPRO
Fusta	FUSTA
Grana	GRANA
Empremta Vegetal	IMPRO
Molusc	MOLUSC

Els Objectes Ceràmics documentats poden ser:

Objectes ceràmics	Abreviació
Vora	VORA
Estatlla	ESPATLLA
Panxa	PANXA
Fons	FONS
Nansa	NANSA
Aplicacions	APLICA
Informes	INFORME
Carena	CARENA
Sencera	SENCERA

---

**TIPOMETRIES** : Per sistema no es prendran mesures de cap objecte del registre arqueològic.

---

**ALTERACIONS / OBSERVACIONS** : En aquesta variable s'anoten aquelles incidències que per les seves característiques no es troben compreses en la resta del full d'excavació. Alguns exemples poden ser :

- Aquells objectes **lítics** que per la seva categoria mereixin majors especificacions :

Làmina  
Percussor  
...

- Aquells objectes **ossis** determinables o indeterminables que per la seva categoria mereixin majors especificacions :

Marí  
Mandíbula  
Dent  
...

- Aquells objectes que han patit **alteracions físico-químiques** o d'altra ordre :

Alterat  
Patinat  
Cremat  
Amb Concreció  
Amb Ocre  
...

- Aquells esdeveniments evidenciats a l'excavació :

No Recuperat  
Extraviat  
No guardat (N.G.)  
Trencat  
Remunta amb el nº xxx (REM 20,44;10)  
...

- Senyalar el tipus d'aplicació de que es tracta en el cas de les aplicacions ceràmiques:

Pastilla  
Cordó  
Llengüetes  
Mugró  
Orella  
Llis  
...

- Senyalar la decoració que pogui presentar la ceràmica:

Impresions  
Incisions  
Acanalats  
...

- En el cas dels objectes ossis treballats, senyalar quin tipus d'objecte és:

Penjoll  
Punxó  
Cisell  
Espàtula  
...

- En el cas de BNA fragmentades, senyalar de quin tipus de fractura es tracta:

Frag (Fragmentat: referent a fractures naturals)  
Frac (Fracturat: referent a fractures possiblement antròpiques)



---

#### 4.- EXCAVACIO DE LES ESTRUCTURES MENORS

---

##### - FOSSES:

La seva actuació es farà a partir de la divisió de l'estructura en dos parts equivalents en sentit N/S. S'excavarà primer el sector E i després el sector W. Per la seva excavació s'utilitzaran talles de 10 cm.

Per l'excavació d'aquestes estructures es disposarà d'unes fitxes on s'especifica el treball a realitzar:

- 1) **Signatura:** fa referència a la nomenclatura amb que es designi l'estructura: B12, B9, etc...
- 2) **Tipus d'estructura:** s'especifica de quin tipus de fosa es tracta: enterrament, emmagatzament, deixalles, etc...
- 3) **Situació:** es prendran les coordenades cartesianes del punt central representades per la X i la Y, i la profunditat a que es troba, que respón a la Z, en referència al punt 0 de l'excavació.
- 4) **Localització:** especificar si l'estructura ha estat trobada en el procés de rebaixament de la màquina o bé durant l'excavació o en altres circumstàncies.
- 5) **Dimensions:**
  - 5.1 **Obertura:** es prenen les mesures dels eixos N/S i E/W de l'estructura en centímetres.
  - 5.2 **Base:** es prenen les mesures de la base un cop excavada l'estructura. També seguint els eixos N/S i E/W i en centímetres.
  - 5.3 **Diàmetre:** fa referència al diàmetre màxim de l'estructura.
  - 5.4 **Profunditat:** es prendrà la profunditat del punt que es trobi més baix de la base (cms.)
- 6) **Dibuixos:** es faran a escala 1:10.
  - 6.1 **Planta:** es realitza a l'inici de l'estructura a on es dibuixarà el límit així com tot el material que es trobi en superfície. Es prendran diferents zetes.

Es farà un altre dibuix en planta de l'estructura una vegada estigui excavada prenent igualment zetes.

## **6.2 Estratigrafia:**

**Secció interna:** respón a la que queda després d'haver rebaixat el sector E. Es dibuixa tot el material visible, així com els diferents sediments, prenent les zetes d'aquests. Per dibuixar aquesta secció es colocaran dos claus externs pels que passarà un grover situat a la mateixa altura amb el nivell, a partir del qual es predran les mesures.

**Secció externa:** aquesta queda reflexada a la paret de l'estructura i pel dibuix es fa servir la mateixa tècnica. En cas que sigui homogènia, passa a ser un dibuix merament esquemàtic.

**6.3 Perfils:** un cop buidat el sector Est de l'estructura es dibuixaran els perfils interns seguint l'eix N/S. El procediment és el mateix que pel dibuix de les seccions.

**NOTA:** En casos excepcionals es poden aixecar diferents plantes. La decisió es prendrà in situ.

7) **Foto:** de cada estructura s'ha de fer un mínim de tres fotos: una a l'inici, una altre de la secció i una tercera de l'estructura acabada. En casos excepcionals es poden fer més, senyalant sempre a quina talla han estat realitzades.

**IMPORTANT: SOTA CAP CONCEPTE ES POT COMENÇAR A EXCAVAR SENSE HAVER REALITZAT LA PLANTA I LA FOTOGRAFIA DE L'INICI.**

8) **Talles:** S'excavarà per talles de 10 cm. Així la talla que va de 101 a 110 cm. s'anomenarà talla 11, la que va de 111 a 120 cm., talla 12, i així succesivament. De cada talla es recollirà el material separant-lo pel tipus:

- material lític
- material ceràmic
- material ossi
- altres (moluscs, tovots, etc...)

A la fitxa s'especificarà la talla i en cas de no haver acabat, a quina profunditat es deixa, i el nº de bosses o caixes estretes de cada material. Les mostres que s'hagin agafat pels diferents anàlisis han d'estar senyalades a la fitxa en el seu corresponent apartat. Per norma es recollirà un cubell sense cribar per talla. Aquest sediment haurà de portar escrit a la bossa el següent:

BM91  
Signatura  
Sector  
Talla

La resta de sediment s'haurà de cribar in situ amb un garbell de tela metàlica d'1 cm. i un altre a sota de mms. Això es farà tant pel sector E com el sector W de cada estructura.

9) **Descripció:** Es seguiran les següents pautes:

- descripció de la planta i forma de les parets (rectes, bitroncocòniques, etc...), assenyalant qualsevol alteració i intentant fer referència, sempre que sigui possible, a les talles.
- tipus de reompliment i canvis que es puguin observar tant a l'interior com a les parets.
- anotar qualsevol observació sobre el material: distribució, predomini d'un tipus o un altre, etc...
- qualsevol altra cosa que durant l'excavació es consideri interessant tenir en compte, s'incluirà.

10) **Assaig d'interpretació:** l'excavador/a haurà d'anotar en aquest apartat qualsevol tipus de reflexió que sobre l'estructura s'hagi pogut anar fent al llarg de l'excavació de la mateixa (hipòtesis, anomalies, etc...).

**- ESTRUCTURES D'ENTERRAMENT**

Per la seva excavació s'actuarà damunt tot ella rebaixant de forma sistemàtica el sediment. No es faran servir talles. La fitxa queda exactament igual però no s'omplirà l'apartat de talles, és a dir, s'especificarà el nº de caixes extretes de cada material, el tipus de mostra, etc... Els dibuixos es faran tots a excepció del de la secció interna, mentre que es dibuixarà el mort i el possible aixovar in situ. També es prendran les dimensions tant del mort com de l'estructura.

**- ORDENACIO DEL MATERIAL**

Quan es treballi en quadrícula, coordinant tot el material, s'embolicarà aquest amb paper higiènic, escrivint amb bolígraf, **mai en llapis o rotulador**, el següent:

BM91  
Signatura  
Quadre  
Nº de coordinat

En el cas de les talles, cada caixa haurà de tenir enganxada una etiqueta a on s'especifiqui el següent:

BM91  
Signatura:  
Sector: (E o W)  
Talla:  
Material: (ceràmic, lític...)

3.- ENREGISTRAMENT EN SOPORT MAGNETIC DE LES  
DADES GENERADES A L'EXCAVACIO :  
BASE DE DADES

El software emprat serà dBase III Plus o dBase IV. En cas de treballar amb Coordenades Cartesianes l'estructura de la base de dades ha de ser la següent :

camp	nom camp	tipus	amplada	comentari
1	X_QUADRE	numèric	2	Coordenada X del quadre
2	Y_QUADRE	numèric	2	Coordenada Y del quadre
3	CONJUNT	caràcter	1	Conjunt
4	NIVELL	caràcter	3	Nivell
5	NUMERO	numèric	4	Número de registre
6	X	numèric	3	Coordenada X
7	Y	numèric	3	Coordenada Y
8	Z	numèric	4	Profunditat
9	ORIENTACIO	caràcter	5	Orientació
10	PENDENT	caràcter	2	Pendent
11	MATERIA	caràcter	8	Materia
12	OBJECTE	caràcter	8	Objecte
13	LONG	numèric	4	Longitud
14	AMP	numèric	4	Amplada
15	ESP	numèric	4	Espessor
16	ALT_OBS	caràcter	15	Alteracions /Observacions
17	ANY	numèric	4	Any de la campanya
18	PUNTEJAT	lògic	1	Puntejat Sí / No

Les dades s'introduiran sempre en majúscules.

En cas de treballar per **talles** certs camps de l'estructura exposada anteriorment seran susceptibles de desdoblament a fi i efecte de recollir d'altres dades significatives. Aquests són:

camp	nom camp	tipus	amplada	comentari
4	<b>NIVELL/EE</b>	caràcter	3	Nivell/ Estructura
5	NUMERO	numèric	4	Número de registre
8	<b>Z/TALLA</b>	numèric	4	Profunditat/Talla
10	<b>PENDENT SECTOR</b>	caràcter	2	Pendent/Sector
11	MATERIA	caràcter	8	Materia
12	OBJECTE	caràcter	8	Objecte
16	ALT_OBS	caràcter	15	Alteracions /Observacions
17	ANY	numèric	4	Any de la campanya
18	PUNTEJAT	lògic	1	Puntejat Sí / No

Les dades s'introduiran sempre en **majúscules**, excepte aquelles abreviacions que requereixin l'ús de les minúscules.



## ANNEX II

SECCIONS DE L'ESTRUCTURA D'HABITACIÓ

C-11

# ST 558/559 Ceramiques

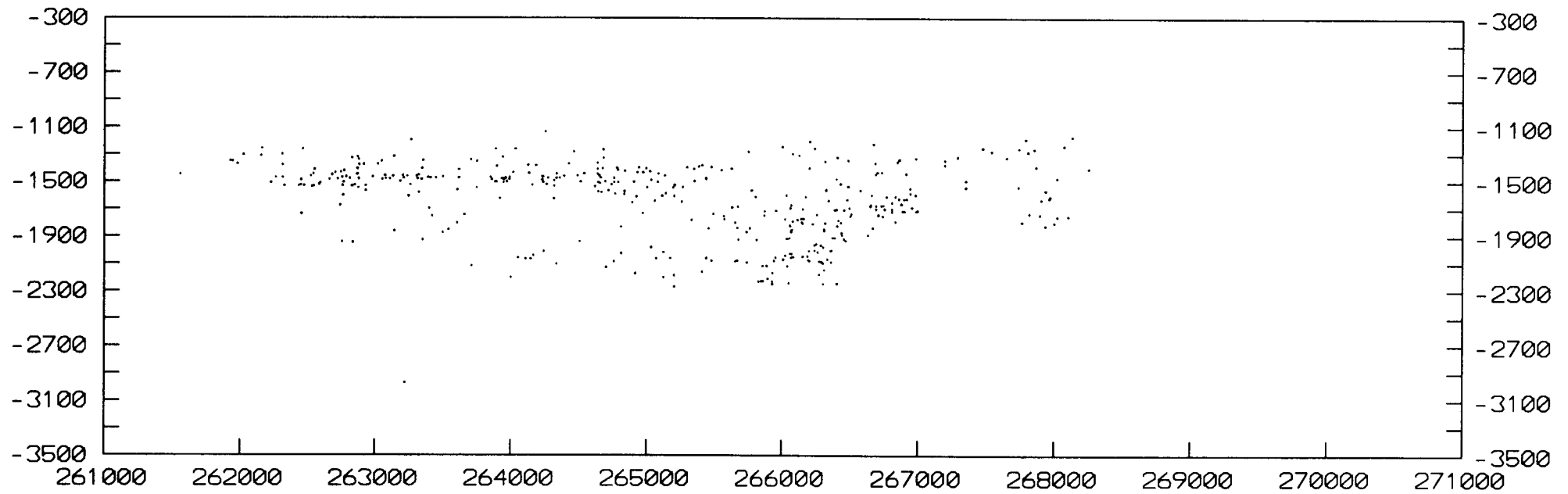



# SS 263 Total Objectes

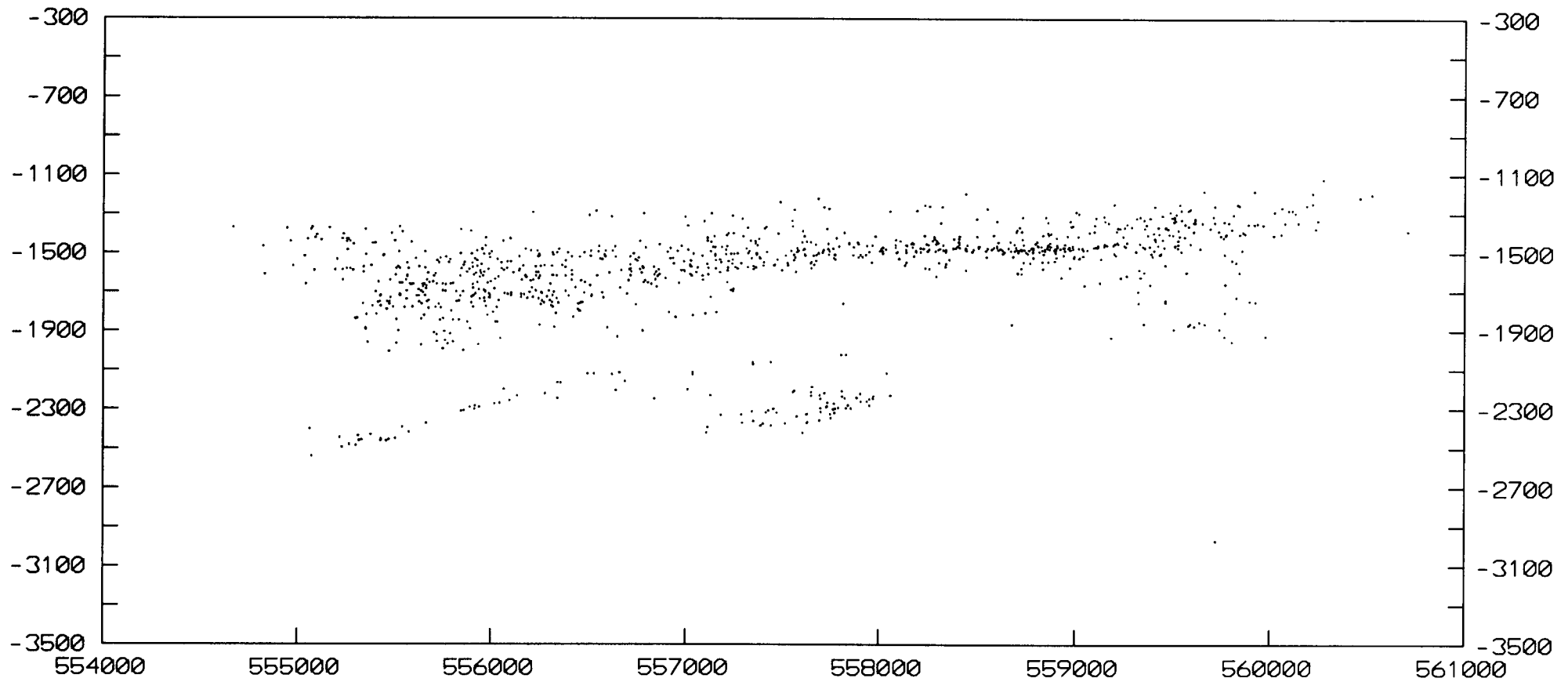

# SS 264 Total Objectes

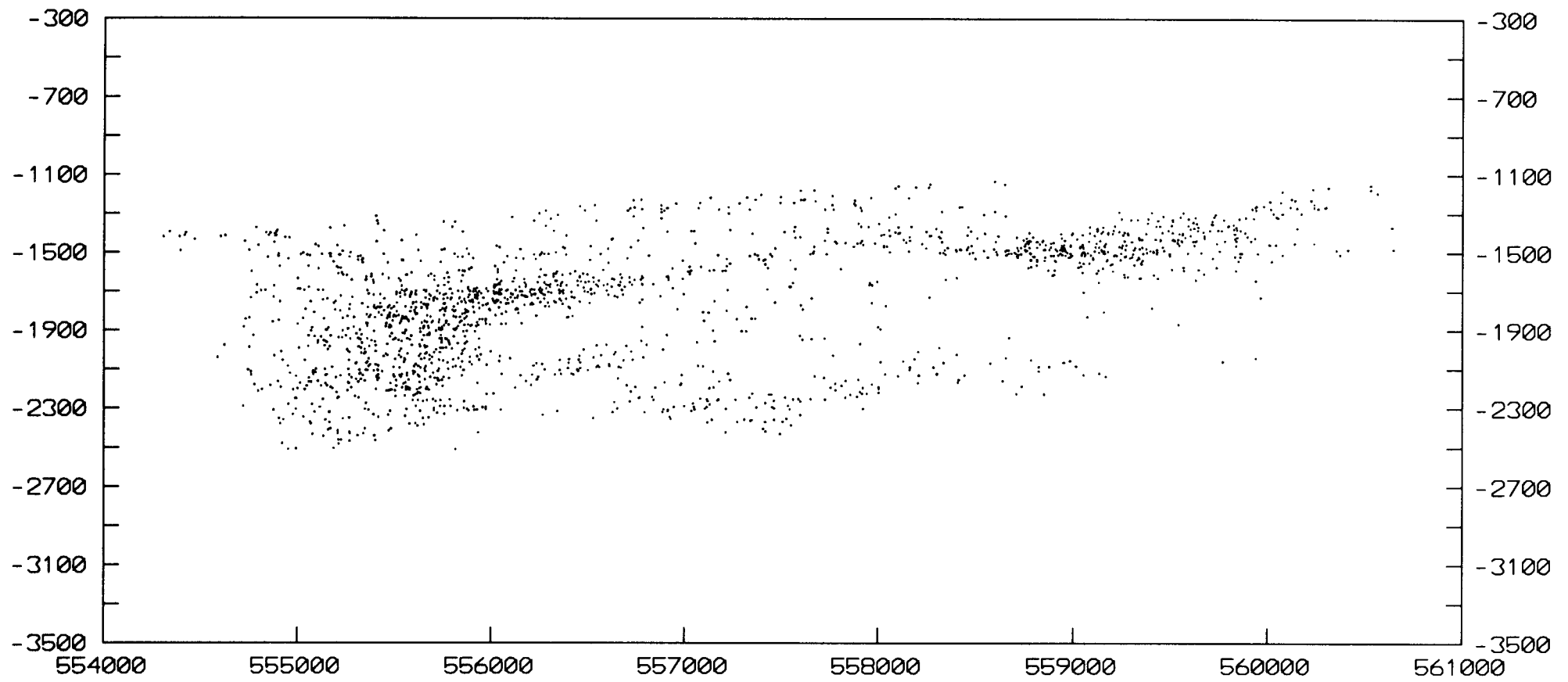

# SS 265 Total Objectes

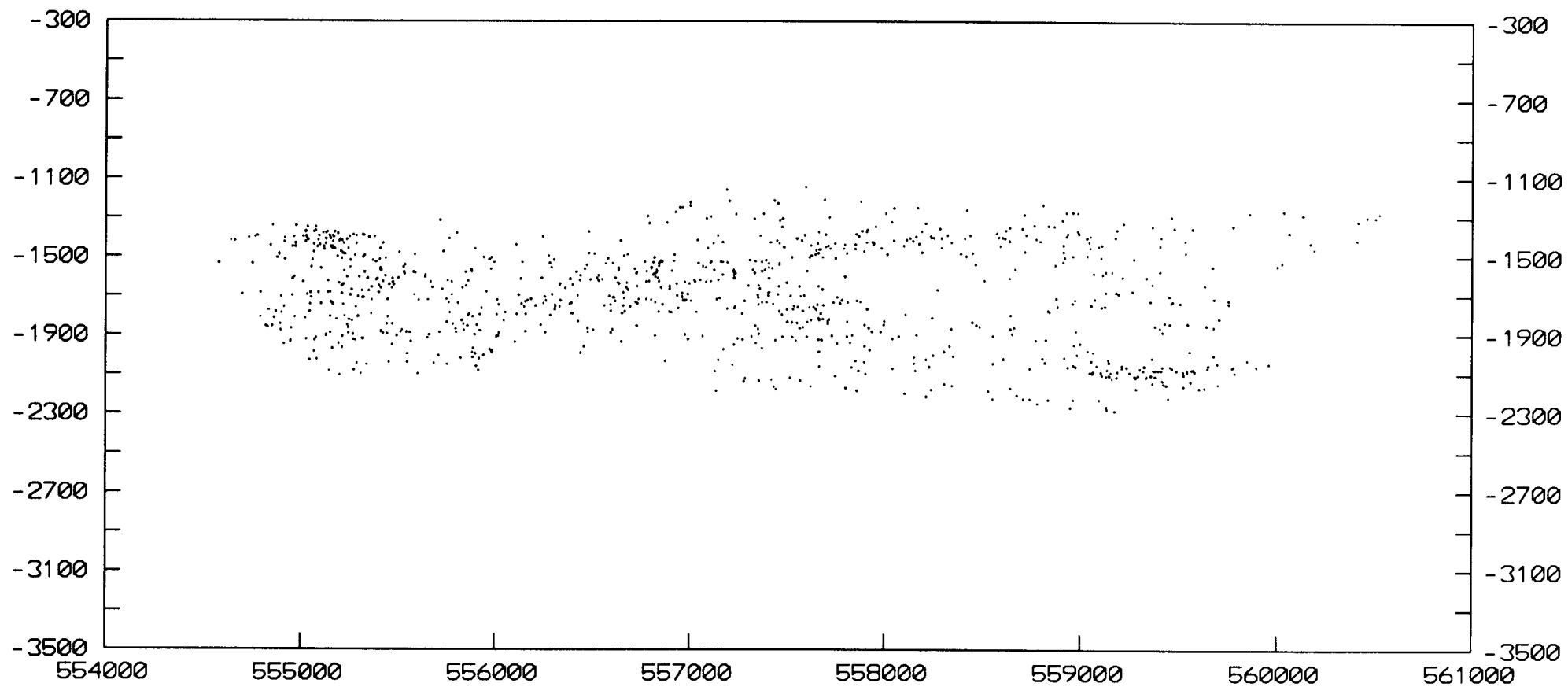

# SS 266 Total Objectes

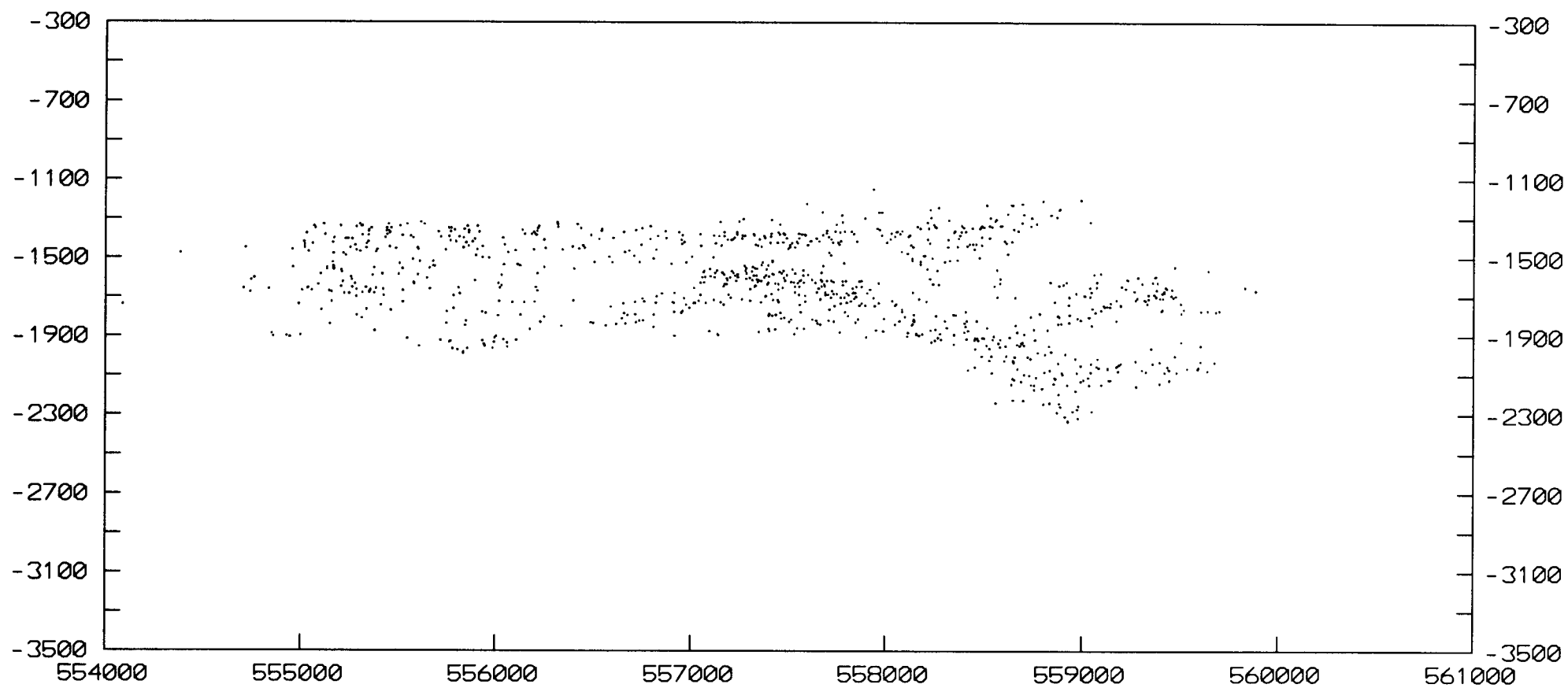

# SS 267 Total Objectes

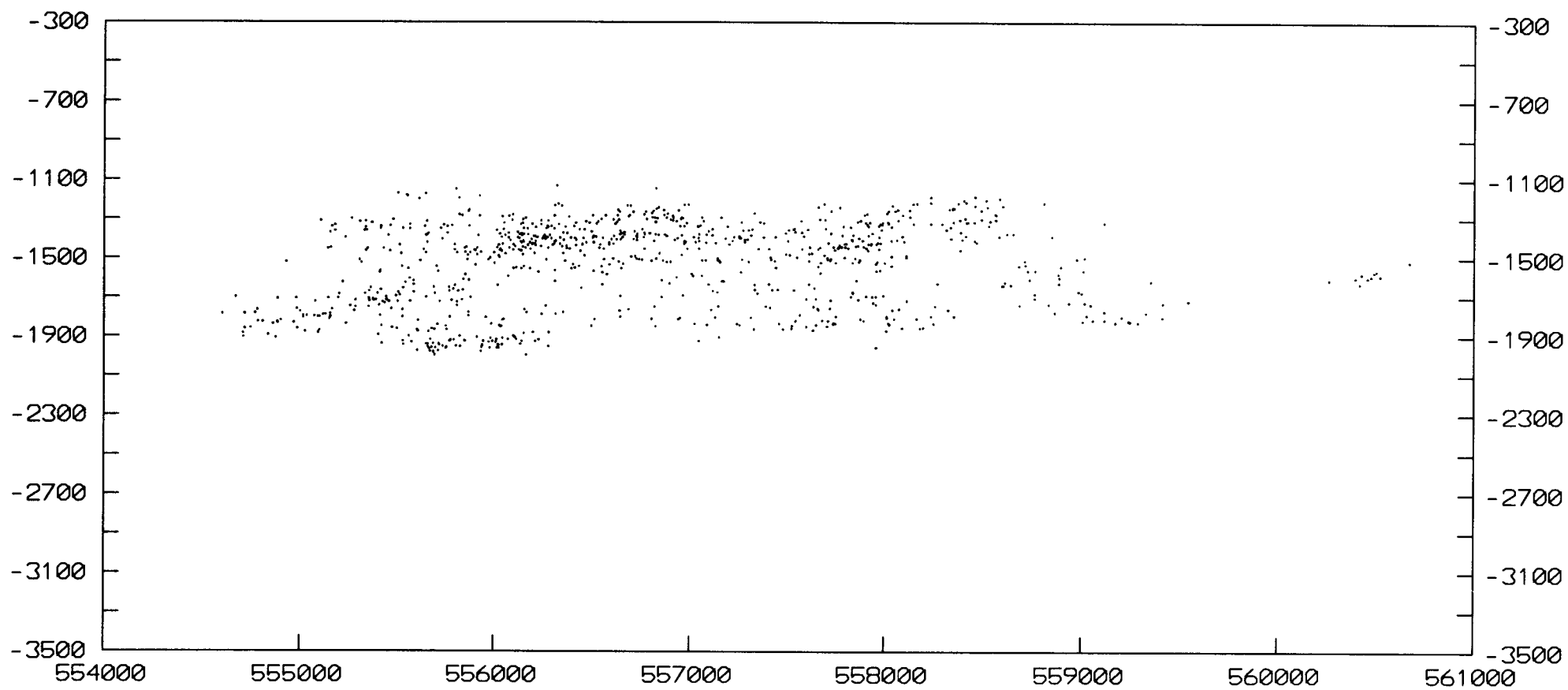

# SS 268 Total Objectes

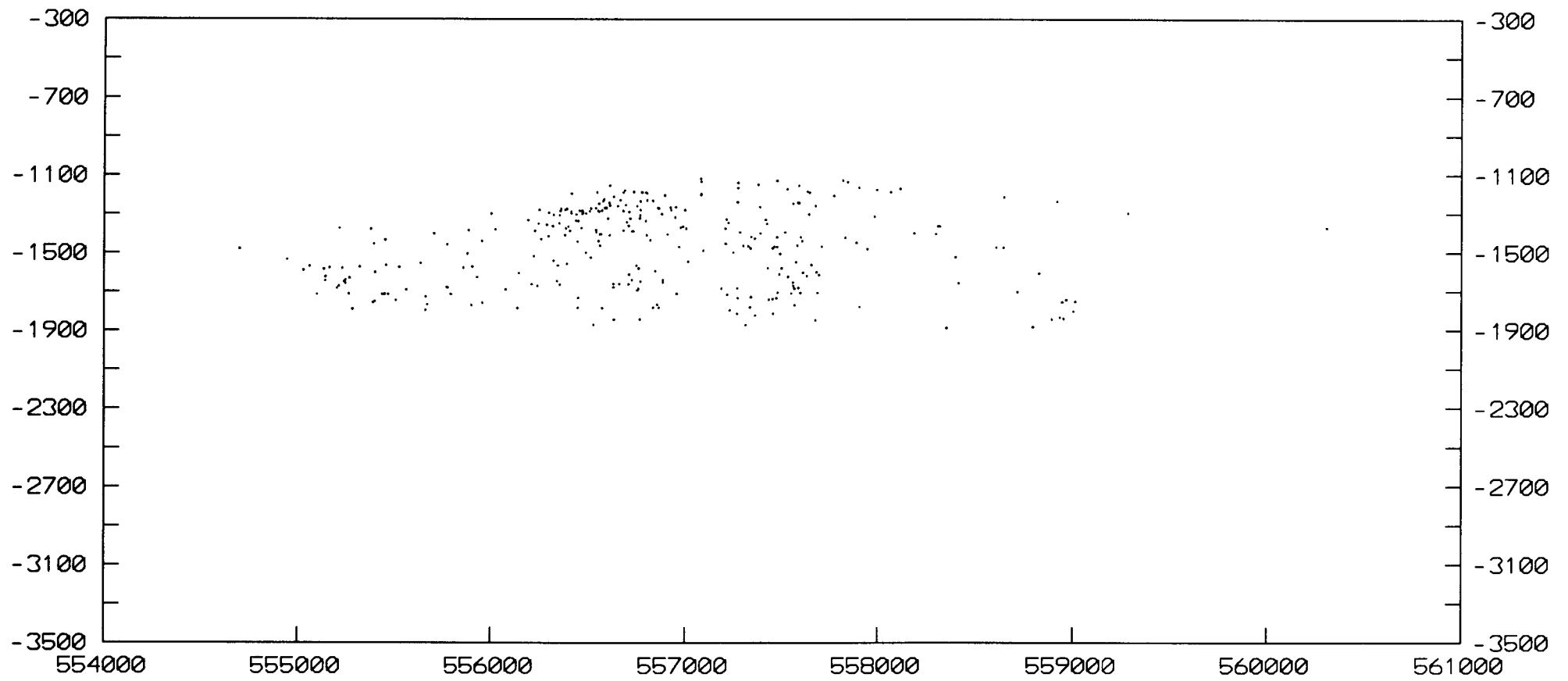

# ST 554/555 Total Objectes

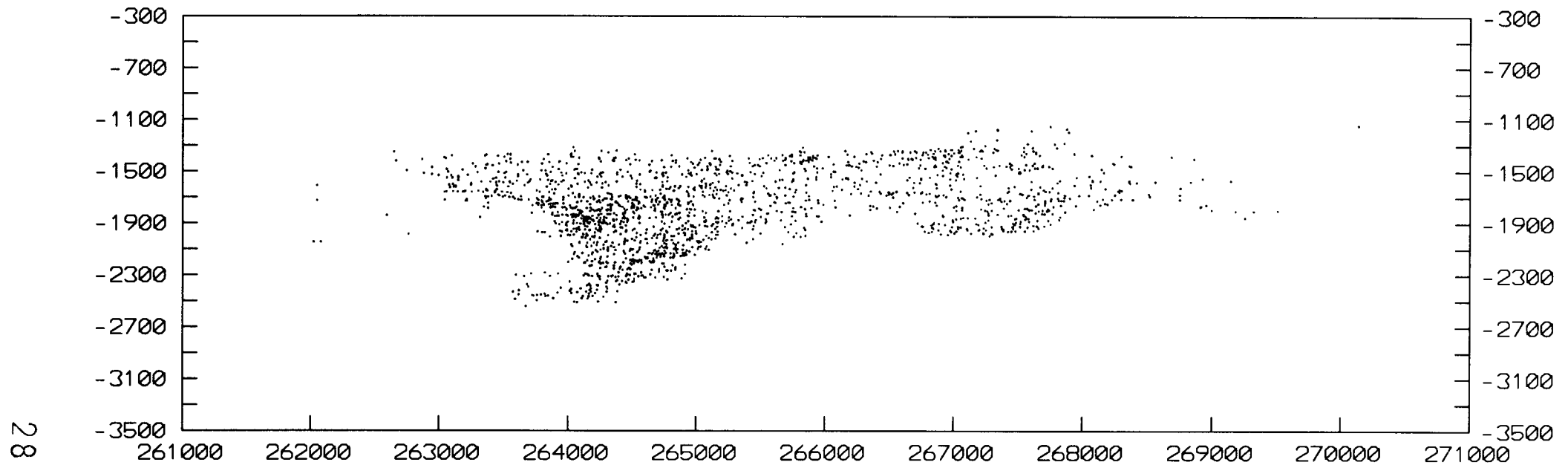



## ANNEX IIIa

INVENTARI DE L'ESTRUCTURA D'HABITACIÓ  
C-11







BOBILA MADURELL  
MAS DURAN  
Objectes Coordenats C5  
Campanya 1991

c	c	C	N	NUM.	X	Y	Zsup	Zinf	ORIENT	PENDENT	MATERIA	OBJECTE	LONG	AMPL	ESPE	ALTERACIONS	OBSERVACIONS	P	D
uX	uY	O	I															ANY	U
a	a	N	V																I
d	d	J																	N
																			B
																			T
																			U
262	556	C	3	79	62	581	0	0			RMI	BNA	0	0	0	FRAG		1991	S
262	556	C	3	80	97	334	1710	1906	V		SORRENCA	BNA	0	0	0	FRAG BNE?		1991	S
262	556	C	3	81	196	292	1785	1889	P		CONGLOME	BNA	0	0	0	FRAG MICROCONGL		1991	S
262	556	C	3	82	111	313	0	1894			ORGANIC	CARBO	0	0	0			1991	S
262	556	C	3	83	261	143	0	1925	P		CALCARIA	BNA	0	0	0	ALTERAT		1991	S
262	556	C	3	84	769	653	0	1938			INDET	BNA	0	0	0	ALTERAT		1991	S
262	556	C	3	85	568	653	0	1937	N		QUARS	BNA	0	0	0	FRAG		1991	S
262	556	C	3	86	852	722	0	1925	NW		CERAMICA	APLICA	0	0	0	MUGRO		1991	
262	556	C	3	87	981	624	0	1910	NW		CERAMICA	INFORME	0	0	0			1991	
262	556	C	3	88	391	638	0	2010	P		CERAMICA	INFORME	0	0	0	2 FRAGS		1991	S
262	557	C		1	270	207	0	1322	SW		SORRENCA	BNA	0	0	0	FRAG		1991	S
262	557	C		2	292	250	0	1324	E		CERAMICA	INFORME	0	0	0			1991	S
262	557	C		3	247	325	0	1314	E		SORRENCA	BNA	0	0	0	FRAG		1991	S
262	557	C		4	179	343	0	1315	NE		SORRENCA	BNA	0	0	0	FRAG		1991	S
262	557	C		5	510	307	0	1310	NW		CERAMICA	INFORME	0	0	0			1991	S
262	557	C		6	619	562	0	1350	SE		SORRENCA	BNA	0	0	0	FRAG		1991	S
262	557	C		7	649	936	0	1307	E		SORRENCA	BNA	0	0	0			1991	S
262	557	C		8	252	987	0	1260	SW		CALCARIA	BNA	0	0	0	FRAG		1991	S
262	557	C		9	85	880	0	1291	NE		RMI	BNA	0	0	0	FRAG		1991	S
262	557	C		10	38	836	0	1261	NE		QUARSITA	BNA	0	0	0	FRAG		1991	S
262	557	C		11	368	273	0	1357	P		QUARS	BNA	0	0	0	FRAG		1991	S
262	557	C		12	67	237	0	1352	P		SORRENCA	BNA	0	0	0	FRAG		1991	S
262	557	C		13	325	632	0	1346	P		CERAMICA	INFORME	0	0	0			1991	S
262	557	C		14	305	687	0	1344	NW		QUARS	BNA	0	0	0	FRAG		1991	S
262	557	C		15	207	635	0	1346	V		QUARS	BNA	0	0	0	FRAG		1991	S
262	557	C		16	204	768	0	1336	V		CALCARIA	BPI	0	0	0			1991	S
262	557	C		17	422	823	0	1340	NE		SORRENCA	BNA	0	0	0	NO RECUPERAT		1991	S
262	557	C		18	204	861	0	1345	NE		RMI	BNA	0	0	0	FRAG		1991	S
262	557	C		19	939	705	0	1335	V		CERAMICA	INFORME	0	0	0			1991	S
262	557	C		20	950	628	0	1325	NE		QUARS	BPI	0	0	0	2 FRAGS		1991	S
262	557	C		21	818	92	1311	1358	NE		SORRENCA	BNA	0	0	0			1991	S
262	557	C		22	610	158	0	1375	E		SORRENCA	BNA	0	0	0	FRAG		1991	S
262	557	C		23	386	72	0	1372			SILEX	BN2G	0	0	0			1991	S
262	557	C		24	289	38	0	1364	E		CERAMICA	VORA	0	0	0			1991	S
262	557	C		25	952	306	0	1384	N		SORRENCA	BNA	0	0	0	FRAG		1991	S
262	557	C		26	343	834	0	1372	P		CALCARIA	BNA	0	0	0	FRAC		1991	S
262	557	C		27	477	799	0	1395	S		SORRENCA	BNA	0	0	0	FRAG		1991	S
262	557	C		28	639	807	0	1384	P		RMI	BNA	0	0	0			1991	S
262	557	C		29	314	956	0	1370	W		CERAMICA	INFORME	0	0	0			1991	S
262	557	C		30	506	977	0	1377	W		SILEX	BP	0	0	0			1991	S
262	557	C		31	816	908	0	1382	S		RMI	BNA	0	0	0	FRAG		1991	S
262	557	C		32	486	48	0	1395	NE		CALCARIA	BNA	0	0	0	FRAG		1991	S
262	557	C		33	511	925	0	1412	P		QUARS	BNA	0	0	0	FRAG NO RECUPER		1991	S
262	557	C		35	767	746	0	1412	E		QUARS	BP	0	0	0			1991	S
262	557	C		36	979	803	1350	1400	E		RMI	BNA	0	0	0	FRAG		1991	S
262	557	C		37	756	962	0	1412	N		RMI	BNA	0	0	0	FRAG		1991	S
262	557	C		38	802	968	0	1417	E		QUARSITA	BNA	0	0	0	FRAG		1991	S
262	557	C	2	39	52	35	0	1325	P		SILEX	BPI	0	0	0			1991	
262	557	C	2	40	251	49	0	1390	E		RMI	BNA	0	0	0	FRAG		1991	S
262	557	C	2	41	440	125	0	1390	N		SORRENCA	BNA	0	0	0	FRAG		1991	S













BOBILA MADURELL  
MAS DURAN  
Objectes Coordenats C5  
Campanya 1991

c	c	C	N	NUM.	X	Y	Zsup	Zinf	ORIENT	PENDENT	MATERIA	OBJECTE	LONG	AMPL	ESPE	ALTERACIONS	OBSERVACIONS	P	D
uX	uY	O	I															ANY	U
a	a	N	V																I
d	d	J																	N
																			B
																			T
																			U
262	558	C	2	135	673	975	0	1456	V		CALCARIA	BPI	0	0	0			1991	S
262	558	C	2	136	768	987	0	1457	S		ESQUIST	BNA	0	0	0	FRAG		1991	S
262	558	C	2	137	743	957	0	1491	S		SORRENCA	BNA	0	0	0	FRAG		1991	S
262	558	C	2	138	753	890	0	1500	V		QUARS	BP	0	0	0	FRAG		1991	S
262	558	C	2	139	761	859	0	1500	W		CALCARIA	BP	0	0	0			1991	S
262	558	C	2	141	847	55	0	1525	SE		CERAMICA	INFORME	0	0	0			1991	S
262	558	C	2	142	867	19	0	1513	P		CALCARIA	BPF	0	0	0	FRAG		1991	S
262	558	C	2	143	471	401	0	1529	P		CERAMICA	INFORME	0	0	0			1991	S
262	558	C	2	144	434	442	0	1529	P		CALCARIA	BNA	0	0	0	FRAG		1991	S
262	558	C	2	145	433	492	0	1530	P		CERAMICA	INFORME	0	0	0			1991	S
262	558	C	2	146	929	273	0	1505	P		QUARS	BPF	0	0	0	FRAG		1991	S
262	558	C	2	147	898	349	0	1511	P		QUARS	BNA	0	0	0	FRAG		1991	S
262	558	C	2	148	883	496	0	1530	V		RMI	BNA	0	0	0	FRAG		1991	S
262	558	C	2	149	737	561	0	1531	P		CONGLOME	BNA	0	0	0	FRAG	MICROCONGL	1991	S
262	558	C	2	150	563	602	0	1522	P		OS	INDET	0	0	0	FRAG		1991	S
262	558	C	2	151	575	544	0	1516	P		OS	INDET	0	0	0	FRAG		1991	S
262	558	C	2	152	594	578	0	1520	P		QUARS	BNA	0	0	0	FRAG		1991	S
262	558	C	2	154	932	770	0	1495	P		SILEX	BPF	0	0	0	FRAG		1991	S
262	558	C	2	155	779	850	0	1505	S		SORRENCA	BNA	0	0	0	FRAG		1991	S
262	558	C	2	156	770	901	0	1473	P		CALCARIA	BP	0	0	0	FRAG		1991	S
262	558	C	2	157	621	866	0	1485	P		CALCARIA	BPF	0	0	0			1991	S
262	558	C	2	158	554	892	0	1489	S		QUARS	BNA	0	0	0	FRAG		1991	S
262	558	C	2	159	447	21	0	1525	P		CERAMICA	INFORME	0	0	0	TERRA CUITA		1991	S
262	558	C	2	160	860	977	0	1522	SE		QUARS	BNA	0	0	0	FRAG		1991	S
262	558	C	2	161	914	912	0	1494	SE		SORRENCA	BNA	0	0	0	FRAG		1991	S
262	558	C	2	162	972	234	0	1525	V		CALCARIA	BNA	0	0	0	FRAG		1991	S
262	558	C	2	163	541	37	0	1532	P		CERAMICA	INFORME	0	0	0	2 FRAGS		1991	S
262	558	C	2	164	528	83	0	1537	P		CERAMICA	INFORME	0	0	0			1991	S
262	558	C	2	165	438	84	0	1534	V		QUARS	BNA	0	0	0	FRAC		1991	S
262	558	C	2	166	901	202	0	1550	P		SORRENCA	BNA	0	0	0	FRAG		1991	S
262	558	C	2	167	928	966	0	1530	P		CERAMICA	INFORME	0	0	0			1991	S
262	558	C	2	168	827	846	0	1533	V		CERAMICA	INFORME	0	0	0			1991	S
262	558	C	2	169	876	935	0	1538	E		QUARS	BNA	0	0	0	FRAG		1991	S
262	558	C	2	170	928	461	0	1566	W		CERAMICA	INFORME	0	0	0			1991	S
262	558	C	2	171	872	831	0	1545	V		CERAMICA	INFORME	0	0	0	2 FRAGS		1991	S
262	558	C	2	172	327	771	0	1530	E		CERAMICA	INFORME	0	0	0			1991	S
262	558	C	2	173	339	949	0	1538	V		OS	INDET	0	0	0			1991	S
262	558	C	2	174	748	16	0	1605	SE		OS	INDET	0	0	0			1991	S
262	558	C	2	175	760	301	0	1600	SE		CERAMICA	INFORME	0	0	0	TERRA CUITA		1991	S
262	558	C	2	176	313	231	1421	1512	E		RMI	BNA	0	0	0			1991	S
262	558	C	3	177	178	550	0	1519	V		OS	INDET	0	0	0			1991	S
262	558	C	3	178	596	970	0	1671	N		ESQUIST	BNA	0	0	0	FRAG		1991	
262	558	C	3	179	739	512	0	1673	W		CERAMICA	INFORME	0	0	0			1991	
262	558	C	3	180	972	916	0	1685	S		CONGLOME	BNA	0	0	0	FRAG		1991	
262	558	C	3	181	803	598	0	1760	V		RMI	BPF	0	0	0			1991	S
262	558	C	3	182	417	535	1692	1803	P		CALCARIA	BNA	0	0	0			1991	S
262	558	C	3	183	508	381	0	1769	P		OS	DET	0	0	0			1991	S
262	558	C	3	184	558	473	0	1807	P		OS	INDET	0	0	0	NO RECUPERAT		1991	S
262	558	C	3	185	569	245	0	1841	SW		SORRENCA	BNA	0	0	0	FRAG		1991	
262	558	C	3	186	423	445	0	1860			ORGANIC	CARBO	0	0	0			1991	S





BOBILA MADURELL  
MAS DURAN  
Objectes Coordenats C5  
Campanya 1991

c	c	C	N	NUM.	X	Y	Zsup	Zinf	ORIENT	PENDENT	MATERIA	OBJECTE	LONG	AMPL	ESPE	ALTERACIONS	OBSERVACIONS	P	D	
uX	uY	O	I															ANY	U	I
a	a	N	V																N	B
d	d	J																	T	U
262	559	C	2	96	237	221	0	1223	P		OS	DET	0	0	0			1991	S	
262	559	C	2	97	461	336	0	1261	E		CERAMICA	INFORME	0	0	0			1991	S	
262	559	C	2	98	161	334	0	1256	E		CERAMICA	INFORME	0	0	0			1991	S	
262	560	C		1	822	134	0	1130	NE		CERAMICA	VORA	0	0	0			1991	S	
262	560	C	3	2	501	364	0	1663	SW		CERAMICA	APLICA	0	0	0	LLENGUETA		1991	S	
262	560	C	3	3	339	421	0	1699	P		CERAMICA	INFORME	0	0	0			1991	S	
263	554	C		1	551	945	0	1375	N-S	N	RMI	BNA	0	0	0			1991	S	
263	554	C		2	529	671	0	1370	E-W	SE	CALCARIA	BNA	0	0	0			1991	S	
263	554	C		3	876	824	0	1467			SILEX	BP	0	0	0	PATINAT		1991	S	
263	554	C		4	794	964	0	1442			QUARS	BPF	0	0	0			1991	S	
263	554	C		5	841	976	0	1568			QUARS	BN2G	0	0	0			1991	S	
263	554	C		6	659	833	0	1610	E-W	V	SILEX	BN2G	0	0	0			1991	S	
263	555	C		2	551	523	0	1367	E-W	P	CERAMICA	INFORME	0	0	0			1991	S	
263	555	C		3	96	347	0	1380		N	CERAMICA	INFORME	0	0	0			1991	S	
263	555	C		4	354	67	0	1380		S	QUARS	BNA	0	0	0	FRAG		1991	S	
263	555	C		5	365	162	0	1373		NE	QUARSITA	BPI	0	0	0			1991	S	
263	555	C		6	549	235	0	1405		NE	SORRENCA	BNA	0	0	0	FRAG NO RECUPER		1991	S	
263	555	C		7	842	74	0	1370		P	QUARS	BNA	0	0	0	FRAG		1991	S	
263	555	C		8	452	840	0	1382		NE	ESQUIST	BNA	0	0	0	FRAG		1991	S	
263	555	C		9	503	892	0	1390		N	SILEX	BN2G	0	0	0			1991	S	
263	555	C		10	553	121	0	1435		N	RMI	BNA	0	0	0	FRAG		1991	S	
263	555	C		11	807	97	0	1408		N	RMI	BNA	0	0	0	FRAG		1991	S	
263	555	C		12	930	89	0	1423		P	CALCARIA	BNA	0	0	0	NO RECUPERAT		1991	S	
263	555	C	2	13	850	252	0	1430		P	GRANIT	BNA	0	0	0	FRAG NO RECUPER		1991	S	
263	555	C	2	14	682	229	0	1429		N	QUARS	BPI	0	0	0			1991	S	
263	555	C	2	15	638	261	0	1430		P	CERAMICA	INFORME	0	0	0			1991	S	
263	555	C	2	16	461	252	0	1443		E	QUARS	BNA	0	0	0			1991	S	
263	555	C	2	17	412	286	0	1456		P	CERAMICA	INFORME	0	0	0			1991	S	
263	555	C	2	18	259	270	0	1442		E	CERAMICA	INFORME	0	0	0			1991	S	
263	555	C	2	19	364	382	0	1452		P	RMI	BNA	0	0	0	FRAG		1991	S	
263	555	C	2	20	606	398	0	1450		P	INDET	BNA	0	0	0	NO RECUPERAT		1991	S	
263	555	C	2	21	984	499	0	1440			CERAMICA	APLICA	0	0	0	CORDO		1991	S	
263	555	C	2	22	374	584	0	1446		V	CALCARIA	BPF	0	0	0			1991	S	
263	555	C	2	23	49	482	0	1401		E	CONGLOME	BNA	0	0	0	FRAG		1991	S	
263	555	C		24	36	537	0	1393		E	RMI	BNA	0	0	0	FRAG		1991	S	
263	555	C	2	25	924	51	0	1430			OS	INDET	0	0	0			1991	S	
263	555	C	2	26	518	968	0	1424		P	CERAMICA	INFORME	0	0	0			1991	S	
263	555	C	2	27	440	884	0	1585		S	SORRENCA	BNA	0	0	0			1991	S	
263	555	C	2	28	325	269	0	1582		SW	QUARS	FRAG	0	0	0			1991	S	
263	555	C	2	29	440	284	0	1590		V	RMI	BNA	0	0	0	FRAG		1991	S	
263	555	C	2	30	496	231	0	1587		S	CALCARIA	BNA	0	0	0	FRAC		1991	S	
263	555	C	2	31	547	192	0	1589		S	QUARS	BNA	0	0	0			1991	S	
263	555	C	2	32	858	337	0	1600		N	RMI	BNA	0	0	0	FRAG		1991	S	
263	555	C	2	33	463	524	0	1580		E	QUARS	BNA	0	0	0	FRAG NO RECUPER		1991	S	
263	555	C	2	34	544	569	0	1581		P	RMI	BNA	0	0	0	FRAG		1991	S	
263	555	C	2	35	867	655	0	1578		V	QUARS	BNA	0	0	0	FRAG		1991	S	
263	555	C	2	36	961	623	0	1572			CERAMICA	INFORME	0	0	0			1991	S	
263	555	C	2	37	875	516	0	1571		P	QUARS	BNA	0	0	0	FRAG		1991	S	
263	555	C	2	38	697	506	0	1580		P	CERAMICA	INFORME	0	0	0			1991	S	
263	555	C	2	39	923	255	0	1485		E	CERAMICA	INFORME	0	0	0			1991	S	











BOBILA MADURELL  
MAS DURAN  
Objectes Coordinats C5  
Campanya 1991

c	c	C	N								ALTERACIONS				P	D					
uX	uY	O	I	NUM.	X	Y	Zsup	Zinf	ORIENT	PENDENT	MATERIA	OBJECTE	LONG	AMPL	ESPE	OBSERVACIONS	ANY	U	I		
a	a	N	V																N	B	
d	d	J																		T	U
263	556	C		2	332	992			0	1316		CALCARIA	BNA	0	0	0		1991	S		
263	556	C		3	561	536	1255	1286			P	RMI	BNA	0	0	0		1991	S		
263	556	C		4	739	780			0	1299		CONGLOME	BNA	0	0	0	FRAG MICROCONGL	1991	S		
263	556	C		5	843	501			0	1309	P	CALCARIA	BNA	0	0	0	FRAG ALTERAT	1991	S		
263	556	C		6	987	211			0	1294		QUARS	BNA	0	0	0	VARIS FRAGS	1991	S		
263	556	C	2	7	423	58			0	1440		SILEX	BP2G	0	0	0		1991	S		
263	556	C	2	8	873	761	1324	1441			N	CALCARIA	BNA	0	0	0	FRAG	1991	S		
263	556	C	2	9	616	95			0	1428	NE	SILEX	BP2G	0	0	0		1991	S		
263	556	C	2	10	485	861			0	1458	P	CONGLOME	BNA	0	0	0	FRAG	1991	S		
263	556	C	2	11	672	633			0	1468	S	SORRENCA	BNA	0	0	0	NO RECUPERAT	1991	S		
263	556	C	2	12	421	551			0	1467	W	QUARS	BNA	0	0	0		1991	S		
263	556	C	2	13	317	345			0	1482	P	ESQUIST	BNA	0	0	0	FRAG	1991	S		
263	556	C	2	14	553	391			0	1500	P	CERAMICA	INFORME	0	0	0		1991	S		
263	556	C	2	15	543	789			0	1475	NW	CERAMICA	INFORME	0	0	0		1991	S		
263	556	C	2	16	329	973			0	1466	SW	CERAMICA	INFORME	0	0	0		1991	S		
263	556	C	2	17	669	452			0	1522	V	ORGANIC	CARBO	0	0	0		1991	S		
263	556	C	2	18	186	916			0	1477	V	RMI	BNA	0	0	0		1991	S		
263	556	C	2	19	805	201			0	1490	W	QUARS	BNA	0	0	0		1991	S		
263	556	C	2	20	504	316			0	1512	S	QUARSITA	BNA	0	0	0	FRAG	1991	S		
263	556	C	2	21	45	174			0	1482	W	CONGLOME	BNA	0	0	0	FRAG	1991	S		
263	556	C	2	22	51	234			0	1491		QUARS	BNA	0	0	0	FRAG NO RECUPER	1991	S		
263	556	C	2	23	859	509			0	1492	NE	CALCARIA	BNA	0	0	0	FRAC	1991	S		
263	556	C	2	24	440	477			0	1500	P	CERAMICA	INFORME	0	0	0		1991	S		
263	556	C	2	25	927	621			0	1491	P	CERAMICA	INFORME	0	0	0		1991	S		
263	556	C	2	26	771	585			0	1491	SW	QUARS	FRAG	0	0	0	NO RECUPERAT	1991	S		
263	556	C	2	27	849	141			0	1520	E	SORRENCA	BNA	0	0	0	FRAG	1991	S		
263	556	C	2	28	858	243			0	1518	P	INDET	BNA	0	0	0	FRAG	1991	S		
263	556	C	2	29	849	141			0	1595	NE	OS	DET	0	0	0		1991	S		
263	556	C	2	30	858	243			0	1508	V	CONGLOME	BNA	0	0	0	FRAG	1991	S		
263	556	C	2	31	958	583			0	1520	P	SORRENCA	BNA	0	0	0	FRAG	1991	S		
263	556	C	2	32	899	508			0	1518	P	INDET	BNA	0	0	0	FRAG	1991	S		
263	556	C	2	33	770	636			0	1522	P	CALCARIA	BP	0	0	0		1991	S		
263	556	C	2	34	671	579			0	1510		CERAMICA	INFORME	0	0	0		1991	S		
263	556	C	2	35	600	410			0	1520	V	CALCARIA	BPF	0	0	0		1991	S		
263	556	C	2	36	439	548			0	1495	P	CERAMICA	INFORME	0	0	0		1991	S		
263	556	C	2	37	323	728			0	1505	S	INDET	BNA	0	0	0		1991	S		
263	556	C	2	38	268	915			0	1530	W	CERAMICA	INFORME	0	0	0		1991	S		
263	556	C	2	39	235	312			0	1500	P	SORRENCA	BNA	0	0	0	FRAG	1991	S		
263	556	C	2	40	32	335			0	1500	S	QUARS	BNA	0	0	0		1991	S		
263	556	C	2	41	599	900			0	1496	P	SILEX	BPI	0	0	0		1991	S		
263	556	C	2	42	650	952			0	1491	N	CALCARIA	BPF	0	0	0		1991	S		
263	556	C	2	43	381	929			0	1527	S	INDET	BNA	0	0	0	FRAG	1991	S		
263	556	C	2	44	346	986			0	1544	P	SORRENCA	BNA	0	0	0	FRAG	1991	S		
263	556	C	2	45	935	98			0	1546	P	CONGLOME	FRAG	0	0	0	NO RECUPERAT	1991	S		
263	556	C	2	46	692	81			0	1546	P	INDET	BNA	0	0	0	FRAG	1991	S		
263	556	C	2	47	924	379			0	1541	W	OS	DET	0	0	0	MD	1991	S		
263	556	C	2	48	941	556			0	1531	S	CERAMICA	INFORME	0	0	0		1991	S		
263	556	C	2	49	895	568			0	1534	S	CERAMICA	INFORME	0	0	0		1991	S		
263	556	C	2	50	752	754			0	1526	SW	SORRENCA	BNA	0	0	0	FRAG	1991	S		
263	556	C	2	51	633	737			0	1536	SE	SORRENCA	BNA	0	0	0	FRAG	1991	S		

BOBILA MADURELL  
MAS DURAN  
Objectes Coordenats C5  
Campanya 1991

c ux a d	c uy a d	C O N V J	N I	NUM.	X	Y	Zsup	Zinf	ORIENT	PENDENT	MATERIA	OBJECTE	LONG	AMPL	ESPE	ALTERACIONS OBSERVACIONS	P ANY	D U I B T U
263	556	C	2	52	691	747	0	1542			CERAMICA	APLICA	0	0	0	CORDO	1991	S
263	556	C	2	53	924	933	0	1555			CERAMICA	INFORME	0	0	0		1991	S
263	556	C	2	54	583	831	0	1573	S		RMI	BNA	0	0	0		1991	S
263	556	C	2	55	227	378	0	1575	NW		CERAMICA	INFORME	0	0	0		1991	S
263	556	C	2	56	952	251	0	1570	S		RMI	BNA	0	0	0	FRAG	1991	S
263	556	C	2	57	441	49	0	1552	P		CONGLOME	BNA	0	0	0	FRAG	1991	S
263	556	C	2	58	224	50	0	1582	P		RMI	BNA	0	0	0	FRAG	1991	S
263	556	C	2	59	131	29	1469	1534	N		SORRENCA	BNA	0	0	0	FRAG	1991	S
263	556	C	2	60	356	238	0	1520	W		CERAMICA	INFORME	0	0	0		1991	S
263	556	C	2	61	370	711	0	1561	P		SORRENCA	BNA	0	0	0	FRAG	1991	S
263	556	C	2	62	153	361	0	1565	NW		RMI	BNA	0	0	0	FRAG	1991	S
263	556	C	2	63	370	711	0	1520	E		RMI	BPI	0	0	0		1991	S
263	556	C	2	64	265	714	0	1582	P		CONGLOME	BNA	0	0	0	FRAG	1991	S
263	556	C	2	65	646	777	0	1580	SE		CONGLOME	BNA	0	0	0	FRAG	1991	S
263	556	C	2	66	340	79	0	1580	P		RMI	BNA	0	0	0	FRAG	1991	S
263	556	C	2	67	205	62	0	1590	P		CERAMICA	INFORME	0	0	0		1991	S
263	556	C	2	68	219	162	0	1568	S		RMI	BNA	0	0	0	FRAG	1991	S
263	556	C	2	69	265	143	0	1585	S		CALCARIA	BP	0	0	0		1991	S
263	556	C	2	70	204	270	0	1566	P		CERAMICA	VORA	0	0	0		1991	S
263	556	C	2	71	266	308	0	1569	W		CERAMICA	INFORME	0	0	0		1991	S
263	556	C	2	72	33	225	0	1572	W		RMI	BNA	0	0	0	FRAG	1991	S
263	556	C	2	73	185	775	0	1572	W		CERAMICA	INFORME	0	0	0		1991	S
263	556	C	2	74	461	761	0	1585	E		QUARSITA	BNA	0	0	0		1991	S
263	556	C	2	75	424	989	0	1596	E		CERAMICA	INFORME	0	0	0		1991	S
263	556	C	2	76	632	972	0	1590	SE		CERAMICA	INFORME	0	0	0		1991	S
263	556	C	2	77	581	227	0	1601	E		RMI	BNA	0	0	0	FRAG	1991	S
263	556	C	2	78	707	713	0	1617	P		QUARSITA	BNA	0	0	0		1991	S
263	556	C	2	79	681	227	0	1619	V		RMI	BNA	0	0	0	FRAG	1991	S
263	556	C	2	80	616	412	0	1614	N		RMI	BNA	0	0	0	FRAG	1991	S
263	556	C	2	81	462	542	0	1618	V		CERAMICA	INFORME	0	0	0		1991	S
263	556	C		82	562	604	0	1603	P		CALCARIA	BNA	0	0	0	NO RECUPERAT	1991	S
263	556	C	2	83	641	665	0	1590	W		CALCARIA	BN1G	0	0	0	ALTERAT	1991	S
263	556	C	2	84	618	706	0	1585	V		RMI	BNA	0	0	0	FRAG	1991	S
263	556	C	2	85	556	717	0	1597	S		QUARS	BNA	0	0	0	FRAC	1991	S
263	556	C	2	86	525	714	0	1582	N		CALCARIA	BNA	0	0	0	FRAG	1991	S
263	556	C	2	87	993	987	0	1590	S		QUARS	BNA	0	0	0		1991	S
263	556	C	2	88	113	856	0	1586	S		QUARS	BPI	0	0	0		1991	S
263	556	C	2	89	199	860	0	1611	SW		CERAMICA	INFORME	0	0	0	2 FRAGS	1991	S
263	556	C	2	90	250	891	0	1631	P		CALCARIA	BP	0	0	0		1991	S
263	556	C	2	91	74	410	0	1592	P		RMI	BNA	0	0	0	FRAG	1991	S
263	556	C	2	92	512	311	0	1616	SW		QUARS	BNA	0	0	0	FRAG	1991	S
263	556	C	2	93	105	238	0	1602	V		CERAMICA	INFORME	0	0	0		1991	S
263	556	C	2	94	945	834	0	1612	SW		CERAMICA	INFORME	0	0	0		1991	S
263	556	C	2	95	609	842	0	1598	W		SORRENCA	BNA	0	0	0	FRAG	1991	S
263	556	C	2	96	115	770	0	1603	SW		CALCARIA	BPF	0	0	0		1991	S
263	556	C	2	97	132	173	0	1617	E		SORRENCA	BNA	0	0	0	FRAG	1991	S
263	556	C	2	98	102	111	0	1603	E		QUARS	BNA	0	0	0	FRAG	1991	S
263	556	C	2	99	93	315	0	1617	N		CERAMICA	INFORME	0	0	0		1991	S
263	556	C	2	100	16	333	0	1619	NW		CALCARIA	BNA	0	0	0		1991	S
263	556	C	2	101	90	379	0	1619	NE		QUARS	BNA	0	0	0	FRAG	1991	S

BOBILA MADURELL  
MAS DURAN  
Objectes Coordinats C5  
Campanya 1991

c	c	C	N											ALTERACIONS			P	D			
uX	uY	O	I	NUM.	X	Y	Zsup	Zinf	ORIENT	PENDENT	MATERIA	OBJECTE	LONG	AMPL	ESPE	OBSERVACIONS	ANY	U	I		
a	a	N	V																	N	B
d	d	J																		T	U
263	556	c	2	102	256	787			0	1642	N	QUARS	BNA	0	0	0	FRAG	1991	S		
263	556	c	2	103	330	838			0	1637	P	CALCARIA	BNA	0	0	0	FRAG ALTERAT	1991	S		
263	556	c	2	104	708	961			0	1655	P	CALCARIA	BPI	0	0	0	ALTERAT	1991	S		
263	556	c	2	105	795	779			0	1652	V	CERAMICA	INFORME	0	0	0		1991	S		
263	556	c	2	106	952	479			0	1652	S	OS	DET	0	0	0		1991	S		
263	556	c	2	107	743	410			0	1641	NE	CALCARIA	FRAG	0	0	0	NO RECUPERAT	1991	S		
263	556	c	2	108	636	17			0	1636	SE	CALCARIA	FRAG	0	0	0	NO RECUPERAT	1991	S		
263	556	c	2	109	376	34			0	1624	SE	QUARS	BNA	0	0	0	2 FRAGS	1991	S		
263	556	c	2	110	299	174			0	1625	W	ESQUIST	BNA	0	0	0	FRAG	1991	S		
263	556	c	2	111	241	155			0	1640	P	RMI	BNA	0	0	0	FRAG	1991	S		
263	556	c	2	112	131	179			0	1627	W	CERAMICA	INFORME	0	0	0		1991	S		
263	556	c	2	113	184	241			0	1633	P	CERAMICA	INFORME	0	0	0		1991	S		
263	556	c	2	114	104	247			0	1620	NE	RMI	BNA	0	0	0	FRAG	1991	S		
263	556	c	2	115	53	459			0	1643	P	SILEX	BN2G	0	0	0		1991	S		
263	556	c	2	116	107	505			0	1668	P	SILEX	BPF	0	0	0		1991	S		
263	556	c	2	117	442	846			0	1673	P	CERAMICA	INFORME	0	0	0		1991	S		
263	556	c	2	118	33	213			0	1641	SE	CERAMICA	INFORME	0	0	0	TERRA CUITA	1991			
263	556	c	2	119	104	702			0	1642	P	RMI	BNA	0	0	0	FRAG	1991	S		
263	556	c	2	120	13	850			0	1620	S	QUARS	BNA	0	0	0	FRAG	1991	S		
263	556	c	2	121	227	13	1600		1685		P	CONGLOME	FRAG	0	0	0		1991			
263	556	c	2	122	104	199			0	1645	S	QUARS	BPI	0	0	0		1991	S		
263	556	c	2	123	49	300			0	1660	NE	SORRENCA	BNA	0	0	0	ALTERAT?	1991	S		
263	556	c	2	124	235	660			0	1680	NW	ESQUIST	BNA	0	0	0	FRAG	1991	S		
263	556	c	2	125	75	801			0	1653	S	QUARS	BNA	0	0	0	FRAG	1991	S		
263	556	c	2	126	191	818			0	1660	S	CONGLOME	BNA	0	0	0	FRAG MICROCONGL	1991	S		
263	556	c	2	127	682	205			0	1680	SE	CALCARIA	BNA	0	0	0	FRAC	1991	S		
263	556	c	2	128	848	429			0	1679		SILEX	BPI	0	0	0		1991	S		
263	556	c	2	129	737	226			0	1695	V	QUARS	BNA	0	0	0	FRAG	1991	S		
263	556	c	2	130	855	101			0	1707	E	CALCARIA	BPF	0	0	0		1991	S		
263	556	c	2	131	751	293			0	1696	S	SILEX	BP	0	0	0		1991	S		
263	556	c	2	132	58	83			0	1713	V	SORRENCA	BNA	0	0	0	FRAG	1991	S		
263	556	c	2	133	959	258			0	1708	SE	INDET	BNA	0	0	0		1991	S		
263	556	c	2	136	731	319			0	1702	E	CALCARIA	BNA	0	0	0	FRAG	1991	S		
263	556	c	2	137	866	379			0	1698	P	QUARS	BPF	0	0	0		1991	S		
263	556	c	2	138	908	254			0	1705	P	QUARS	BPI	0	0	0		1991			
263	556	c	2	139	898	476			0	1706	E	CERAMICA	INFORME	0	0	0		1991	S		
263	556	c	2	140	968	567			0	1705	E	QUARS	BNA	0	0	0	FRAG	1991	S		
263	556	c	2	141	894	694			0	1711	P	SORRENCA	BNA	0	0	0	FRAG	1991	S		
263	556	c	2	142	176	100			0	1721	P	QUARS	BN2G	0	0	0		1991	S		
263	556	c	2	143	674	167			0	1715	SE	CALCARIA	BNA	0	0	0		1991	S		
263	556	c	2	144	749	194			0	1704	NE	SORRENCA	BNA	0	0	0	FRAG	1991	S		
263	556	c	2	145	24	183			0	1734	S	SORRENCA	BNA	0	0	0	FRAG	1991	S		
263	556	c	2	146	115	211			0	1729	S	SORRENCA	BNA	0	0	0	FRAG	1991	S		
263	556	c	2	147	36	284			0	1726	E	CALCARIA	BNA	0	0	0		1991	S		
263	556	c	2	148	174	512			0	1724	P	SORRENCA	BNA	0	0	0	FRAG	1991	S		
263	556	c	2	149	106	514			0	1718	E	CALCARIA	BNA	0	0	0	FRAG	1991	S		
263	556	c	2	150	26	574			0	1730	P	QUARS	BNA	0	0	0	FRAC	1991	S		
263	556	c	2	151	110	240			0	1736	P	INDET	BNE	0	0	0		1991	S		
263	556	c	2	152	150	298			0	1745	N	SORRENCA	BNA	0	0	0	FRAG	1991	S		
263	556	c	2	153	144	443			0	1762	W	SORRENCA	BNA	0	0	0	FRAG	1991	S		

BOBILA MADURELL  
MAS DURAN  
Objectes Coordinats C5  
Campanya 1991

c	c	C	N	NUM.	X	Y	Zsup	Zinf	ORIENT	PENDENT	MATERIA	OBJECTE	LONG	AMPL	ESPE	ALTERACIONS OBSERVACIONS	P	D			
uX	uY	O	I														ANY	U	I		
a	a	N	V																N	B	
d	d	J																		T	U
263	556	C	2	154	60	467	0	1755	W		SILEX	BN1G	0	0	0		1991	S			
263	556	C	2	155	851	66	0	1710	P		CONGLOME	BNA	0	0	0	MICROCO.	FRAG	1991	S		
263	556	C	2	156	756	151	0	1713	W		QUARS	BNA	0	0	0	NO RECUPERAT	1991	S			
263	556	C	2	157	957	268	0	1756	P		QUARS	BNA	0	0	0	FRAG	1991	S			
263	556	C	2	158	767	312	0	1720	NE		INDET	BNE	0	0	0		1991	S			
263	556	C	2	159	855	395	0	1722	P		SORRENCA	BNA	0	0	0	FRAG	1991	S			
263	556	C	2	160	966	36	0	1745	N		CALCARIA	BNA	0	0	0	FRAG	1991	S			
263	556	C	2	161	863	152	0	1729	W		CERAMICA	INFORME	0	0	0		1991	S			
263	556	C	2	163	859	257	0	1746	N		CERAMICA	INFORME	0	0	0		1991	S			
263	556	C	2	164	838	333	0	1735	E		CERAMICA	INFORME	0	0	0		1991	S			
263	556	C	2	165	896	310	0	1755	P		CERAMICA	INFORME	0	0	0		1991	S			
263	556	C	2	166	970	342	0	1757	SE		RMI	BNA	0	0	0	FRAG	1991	S			
263	556	C	2	167	840	459	0	1756	S		CERAMICA	INFORME	0	0	0		1991	S			
263	556	C	2	168	730	448	0	1761	S		CALCARIA	BNA	0	0	0		1991	S			
263	556	C	2	169	801	25	0	1780	SE		SORRENCA	BNA	0	0	0	FRAG	1991	S			
263	556	C	2	170	884	252	0	1765	E		QUARSITA	BNA	0	0	0		1991	S			
263	556	C	2	171	953	313	0	1778	P		ESQUIST	BNA	0	0	0	FRAG	1991	S			
263	556	C	2	172	747	304	0	1771	SW		QUARS	BPF	0	0	0		1991	S			
263	556	C	2	173	930	6	0	1805	E		RMI	BNA	0	0	0	FRAG	1991	S			
263	556	C	2	174	803	449	0	1798	S		SORRENCA	BNE	0	0	0		1991	S			
263	556	C	2	175	712	454	0	1799	P		SORRENCA	BNA	0	0	0	NO RECUPERAT	1991	S			
263	556	C	2	176	978	442	0	1790	SW		QUARS	BPI	0	0	0		1991	S			
263	556	C	2	177	27	329	0	1811	N		RMI	BNA	0	0	0	FRAC	1991	S			
263	556	C	2	178	93	908	1555	1805	V		CALCARIA	BNA	0	0	0		1991	S			
263	556	C	2	179	13	740	0	1766	V		SILEX	BNA	0	0	0	FRAG	1991	S			
263	556	C	2	180	766	419	0	1830	S		CERAMICA	INFORME	0	0	0		1991	S			
263	556	C	2	181	823	322	0	1882	S		OS	INDET	0	0	0		1991	S			
263	556	C	2	182	855	246	0	1871	P		RMI	BNA	0	0	0	FRAG	1991	S			
263	556	C	2	183	925	30	0	1856	E		SORRENCA	BNA	0	0	0	FRAG	1991	S			
263	556	C	2	184	615	19	0	1855	S		SILEX	BN2G	0	0	0		1991	S			
263	556	C	2	185	883	45	0	1940	NE		CONGLOME	BNA	0	0	0	MICROCONGL	FRAG	1991	S		
263	556	C	2	186	37	594	1728	1884	E		CONGLOME	BNA	0	0	0		1991	S			
263	556	C	2	187	66	776	1730	1900	V		CONGLOME	BNA	0	0	0	MICROCONGLOME	1991	S			
263	556	C	2	188	66	943	0	1830	V		CERAMICA	INFORME	0	0	0		1991	S			
263	556	C	3	189	47	647	0	1930	NW		CERAMICA	VORA	0	0	0	VARIS FRAGS	1991	S			
263	556	C	3	190	717	658	0	2114	P		CERAMICA	INFORME	0	0	0		1991	S			
263	556	C	3	191	852	356	0	2166	W		QUARSITA	BNA	0	0	0	FRAC	1991	S			
263	556	C	3	192	764	495	0	2120	P		QUARS	BNA	0	0	0	FRAC	1991	S			
263	556	C	3	193	757	528	0	2119	P		RMI	BNA	0	0	0	FRAG	1991	S			
263	556	C	3	194	641	620	0	2123	S		CERAMICA	VORA	0	0	0	FRAG DE APLICA	1991	S			
263	556	C	3	195	728	686	0	2159			SILEX	BP2G	0	0	0		1991	S			
263	556	C	3	196	746	339	0	2165	SW		CERAMICA	INFORME	0	0	0		1991	S			
263	556	C	3	197	847	64	0	2198	P		QUARSITA	BNA	0	0	0	FRAC	1991	S			
263	556	C	3	198	434	276	0	2222	S		CERAMICA	INFORME	0	0	0		1991	S			
263	556	C	3	199	245	640	0	2204	SE		CERAMICA	INFORME	0	0	0		1991	S			
263	556	C	3	200	885	133	0	2233	P		RMI	BNA	0	0	0	FRAG	1991	S			
263	556	C	3	201	242	836	0	2247			ORGANIC	CARBO	0	0	0		1991	S			
263	556	C	3	202	351	339	0	2245	W		QUARS	BNA	0	0	0	FRAG	1991	S			
263	556	C	3	203	574	43	0	2270	P		CALCARIA	BNA	0	0	0		1991	S			
263	556	C	3	204	637	16	0	2273	S		QUARS	BNA	0	0	0		1991	S			

BOBILA MADURELL  
MAS DURAN  
Objectes Coordenats C5  
Campanya 1991

c c C N												ALTERACIONS			P D			
uX	uY	O	I	NUM.	X	Y	Zsup	Zinf	ORIENT	PENDENT	MATERIA	OBJECTE	LONG	AMPL	ESPE	OBSERVACIONS	ANY	U I
a	a	N	V															N B
d	d	J															T U	
263	556	C	3	205	638	94	0	2257	E		CERAMICA	INFORME	0	0	0		1991	S
263	557	C		2	498	558	1251	1278	N-S	N	CALCARIA	FRAG	0	0	0		1991	
263	557	C		3	421	737	1266	1274	E-W	E	CALCARIA	BNA	0	0	0	CREMAT	1991	S
263	557	C		4	769	680	1187	1222	N-S	V	CERAMICA	INFORME	0	0	0		1991	S
263	557	C		5	951	483	1195	1240		S	SORRENCA	FRAG	0	0	0		1991	
263	557	C		6	954	711	1210	1266	NW-SE	S	QUARS	FRAG	0	0	0		1991	
263	557	C		7	740	6	0	1361		N	CALCARIA	CODOL	0	0	0	NO RECUPERAT	1991	S
263	557	C		8	694	237	0	1310		NW	RMI	BNA	0	0	0	FRAG	1991	S
263	557	C		9	878	411	0	1367		P	RMI	BNA	0	0	0	FRAG	1991	S
263	557	C		10	407	90	0	1339		W	QUARS	BP	0	0	0		1991	S
263	557	C		11	686	128	0	1298		SE	CERAMICA	INFORME	0	0	0		1991	S
263	557	C		12	542	287	0	1326		NE	QUARS	BNA	0	0	0		1991	S
263	557	C		13	22	549	0	1364		E	SILEX	BN1G	0	0	0		1991	S
263	557	C		14	215	547	0	1335		V	CERAMICA	INFORME	0	0	0		1991	S
263	557	C		15	70	727	0	1377		P	CALCARIA	BNA	0	0	0	NO RECUPERAT	1991	S
263	557	C		16	626	205	1347	1410		W	QUARS	BNA	0	0	0	FRAG	1991	S
263	557	C		17	403	314	1315	1372		NE	RMI	BNA	0	0	0	FRAG	1991	S
263	557	C		18	283	403	0	1375		P	QUARS	BNA	0	0	0	NO RECUPERAT	1991	S
263	557	C		19	194	472	1340	1401		S	SORRENCA	FRAG	0	0	0		1991	
263	557	C		20	174	601	0	1389		P	CERAMICA	INFORME	0	0	0		1991	S
263	557	C	2	21	268	775	0	1424		NE	RMI	BNA	0	0	0	FRAG	1991	S
263	557	C	2	22	356	816	0	1397		NW	QUARS	BNA	0	0	0	FRAC	1991	S
263	557	C	2	23	12	242	0	1400		NE	SORRENCA	BNA	0	0	0	FRAG ALTERAT	1991	S
263	557	C	2	24	20	215	0	1400		S	SORRENCA	BNA	0	0	0	FRAG	1991	S
263	557	C	2	25	490	107	0	1423		NW	CALCARIA	BNA	0	0	0		1991	S
263	557	C	2	26	492	610	0	1415		P	QUARS	BNA	0	0	0	FRAG	1991	S
263	557	C	2	27	982	976	0	1415		SW	QUARSITA	BNA	0	0	0	FRAG	1991	S
263	557	C	2	28	796	107	0	1438		NW	CONGLOME	BNA	0	0	0		1991	S
263	557	C	2	29	643	355	0	1440		NW	QUARS	BNA	0	0	0		1991	S
263	557	C	2	30	448	372	0	1429		SE	QUARS	BPF	0	0	0		1991	S
263	557	C	2	31	277	291	0	1416		P	OS	DET	0	0	0	CREMAT	1991	S
263	557	C	2	32	277	330	0	1438		P	OS	INDET	0	0	0		1991	S
263	557	C	2	33	31	142	0	1416		E	RMI	BNA	0	0	0	FRAG	1991	S
263	557	C	2	34	32	125	0	1444		N	RMI	BNA	0	0	0	FRAG	1991	S
263	557	C	2	35	343	598	0	1446		NW	CALCARIA	BP	0	0	0		1991	S
263	557	C	2	36	669	669	0	1457		NW	RMI	BNA	0	0	0		1991	S
263	557	C	2	37	675	733	0	1454		W	RMI	BNA	0	0	0	2 FRAGS	1991	S
263	557	C	2	38	668	788	0	1467		NE	QUARS	BPI	0	0	0		1991	S
263	557	C	2	39	915	643	0	1445		SE	RMI	BNA	0	0	0	FRAG	1991	S
263	557	C	2	40	479	886	0	1446		SW	SORRENCA	BNA	0	0	0	FRAG	1991	S
263	557	C	2	41	444	841	0	1450		NW	RMI	BNA	0	0	0	FRAG	1991	S
263	557	C	2	42	197	961	0	1461		P	CALCARIA	BNA	0	0	0	FRAG NO RECUPER	1991	S
263	557	C	2	43	173	933	0	1463		NW	CALCARIA	BNA	0	0	0	FRAG NO RECUPER	1991	S
263	557	C	2	44	535	889	0	1455		S	CERAMICA	INFORME	0	0	0		1991	S
263	557	C	2	45	963	622	0	1443		NW	RMI	BNA	0	0	0		1991	S
263	557	C	2	46	826	540	0	1490		NE	QUARSITA	BNA	0	0	0	FRAG	1991	S
263	557	C	2	47	228	208	0	1466		P	QUARS	BN1G	0	0	0		1991	S
263	557	C	2	48	234	355	0	1452		P	QUARS	BNA	0	0	0	FRAC	1991	S
263	557	C	2	49	323	365	0	1462		E	CERAMICA	INFORME	0	0	0		1991	S
263	557	C	2	50	852	604	0	1485		V	QUARS	BPI	0	0	0		1991	S

BOBILA MADURELL  
MAS DURAN  
Objectes Coordenats C5  
Campanya 1991

c	c	C	N											ALTERACIONS	P	D			
uX	uY	O	I	NUM.	X	Y	Zsup	Zinf	ORIENT	PENDENT	MATERIA	OBJECTE	LONG	AMPL	ESPE	OBSERVACIONS	ANY	U	I
a	a	N	V															N	B
d	d	J																T	U
263	557	c	2	51	47	708	0	1485	P		QUARS	BNA	0	0	0	FRAC	1991	S	
263	557	c	2	52	31	732	0	1480	P		RMI	BNA	0	0	0	FRAG	1991	S	
263	557	c	2	53	9	611	0	1480	P		CALCARIA	BNA	0	0	0		1991	S	
263	557	c	2	54	91	927	0	1510	P		CALCARIA	BNA	0	0	0	NO RECUPERAT	1991	S	
263	557	c	2	56	460	704	0	1494	P		QUARSITA	BNA	0	0	0		1991	S	
263	557	c	2	57	397	7	0	1485	W		SORRENCA	BNA	0	0	0	FRAG	1991	S	
263	557	c	2	58	753	308	0	1478	P		INDET	BNA	0	0	0	FRAC?	1991	S	
263	557	c	2	59	320	864	0	1470	E		QUARSITA	BNA	0	0	0		1991	S	
263	557	c	2	60	323	839	0	1455	P		SORRENCA	BNA	0	0	0	VARIS FRAGS	1991	S	
263	557	c	2	61	523	758	0	1478	P		QUARS	BP	0	0	0		1991	S	
263	557	c	2	62	881	147	0	1471	P		QUARS	BPF	0	0	0		1991	S	
263	557	c	2	63	857	202	0	1507	W		QUARS	BPI	0	0	0		1991	S	
263	557	c	2	64	881	147	0	1507	V		CALCARIA	BNA	0	0	0		1991	S	
263	557	c	2	65	857	202	0	1485	E		SORRENCA	BNA	0	0	0	FRAG	1991	S	
263	557	c	2	66	863	229	0	1506	N		QUARSITA	BPI	0	0	0		1991	S	
263	557	c	2	67	699	123	0	1493	SW		SORRENCA	BNA	0	0	0	FRAG	1991	S	
263	557	c	2	68	683	263	0	1503	P		CERAMICA	INFORME	0	0	0	ARGILA CUITA	1991	S	
263	557	c	2	69	588	245	0	1506	P		CONGLOME	BNA	0	0	0	FRAG	1991	S	
263	557	c	2	70	448	317	0	1502	P		CALCARIA	BNA	0	0	0	FRAG ALTERAT	1991	S	
263	557	c	2	71	613	513	0	1514	S		QUARS	BPI	0	0	0		1991	S	
263	557	c	2	72	706	571	0	1496	S		QUARS	BNA	0	0	0		1991	S	
263	557	c	2	73	779	573	0	1476	W		SORRENCA	BNA	0	0	0	FRAG	1991	S	
263	557	c	2	74	563	703	0	1500	V		QUARS	BPI	0	0	0		1991	S	
263	557	c	2	75	204	611	0	1508	E		CALCARIA	BPF	0	0	0		1991	S	
263	557	c	2	76	28	684	0	1504	E		INDET	BNA	0	0	0		1991	S	
263	557	c	2	77	22	736	0	1509	P		CERAMICA	INFORME	0	0	0		1991	S	
263	557	c	2	78	83	884	0	1447	E		QUARS	BPI	0	0	0		1991	S	
263	557	c	2	79	138	944	0	1495	W		CALCARIA	BNA	0	0	0	FRAG ALTERAT	1991	S	
263	557	c	2	80	46	999	0	1490	P		CERAMICA	INFORME	0	0	0	2 FRAGS	1991	S	
263	557	c	2	81	621	135	0	1470	P		SORRENCA	BNA	0	0	0	FRAG	1991	S	
263	557	c	2	82	362	181	0	1470	S		SORRENCA	BNA	0	0	0	FRAG	1991	S	
263	557	c	2	83	211	324	0	1491	SW		SORRENCA	BNA	0	0	0		1991	S	
263	557	c	2	84	140	361	0	1501	N		SORRENCA	BNA	0	0	0	FRAG	1991	S	
263	557	c	2	85	202	414	0	1496	NE		CALCARIA	BPF	0	0	0		1991	S	
263	557	c	2	86	377	579	0	1489	P		QUARS	BPF	0	0	0		1991	S	
263	557	c	2	87	466	739	0	1492	V		SILEX	BPF	0	0	0		1991	S	
263	557	c	2	88	271	765	0	1510	P		QUARS	BPF	0	0	0		1991	S	
263	557	c	2	89	236	861	0	1512	S		SORRENCA	BNA	0	0	0	FRAG	1991	S	
263	557	c	2	90	172	670	0	1540	P		SORRENCA	BNA	0	0	0	FRAG	1991	S	
263	557	c	2	91	269	80	0	1515	P		QUARS	BNA	0	0	0	FRAC	1991	S	
263	557	c	2	92	707	147	0	1515	S		SORRENCA	BNA	0	0	0	FRAG	1991	S	
263	557	c	2	93	431	379	0	1529	P		CERAMICA	INFORME	0	0	0		1991	S	
263	557	c	2	94	521	336	0	1528	P		QUARS	BPF	0	0	0		1991	S	
263	557	c	2	95	716	361	0	1510	W		CERAMICA	INFORME	0	0	0		1991	S	
263	557	c	2	96	731	555	0	1510	E		QUARS	BPF	0	0	0		1991	S	
263	557	c	2	97	416	657	0	1514	N		SORRENCA	BNA	0	0	0	FRAG	1991	S	
263	557	c	2	98	380	762	0	1527	W		CALCARIA	BP	0	0	0		1991	S	
263	557	c	2	99	207	910	0	1520	N		QUARS	BPI	0	0	0		1991	S	
263	557	c	2	100	105	615	0	1514	S		CERAMICA	INFORME	0	0	0	2 FRAGS	1991	S	
263	557	c	2	101	100	562	0	1524	E		CERAMICA	INFORME	0	0	0		1991	S	

BOBILA MADURELL  
MAS DURAN  
Objectes Coordinats C5  
Campanya 1991

c	c	C	N											ALTERACIONS	P	D			
uX	uY	O	I	NUM.	X	Y	Zsup	Zinf	ORIENT	PENDENT	MATERIA	OBJECTE	LONG	AMPL	ESPE	OBSERVACIONS	ANY	U	I
a	a	N	V															N	B
d	d	J																T	U
263	557	C	2	102	357	899	0	1510	W		CERAMICA	INFORME	0	0	0		1991	S	
263	557	C	2	103	88	671	0	1511	P		INDET	BPF	0	0	0		1991	S	
263	557	C	2	104	115	682	0	1500	NE		CALCARIA	BNA	0	0	0	FRAG NO RECUPER	1991	S	
263	557	C	2	105	780	35	1452	1505	E		CONGLOME	BNA	0	0	0	FRAG MICROCONGL	1991		
263	557	C	2	106	153	216	0	1543	P		QUARS	BNA	0	0	0		1991	S	
263	557	C	2	107	130	149	0	1538	NE		QUARS	BNA	0	0	0	FRAG	1991	S	
263	557	C	2	108	31	238	0	1535	S		RMI	BNA	0	0	0		1991	S	
263	557	C	2	109	202	375	0	1522	N		RMI	BNA	0	0	0		1991	S	
263	557	C	2	110	135	469	0	1535	S		CALCARIA	BNA	0	0	0	FRAG NO RECUPER	1991	S	
263	557	C	2	111	264	556	0	1538	S		CALCARIA	BNA	0	0	0	FRAG NO RECUPER	1991	S	
263	557	C	2	112	82	522	0	1552	V		ESQUIST	BNA	0	0	0	FRAG	1991		
263	557	C	2	113	56	645	0	1547	S		CERAMICA	INFORME	0	0	0		1991	S	
263	557	C	2	114	67	769	0	1533	S		QUARS	BNIG	0	0	0		1991	S	
263	557	C	2	115	104	768	0	1510	W		CALCARIA	BNA	0	0	0	FRAG ALTERAT	1991	S	
263	557	C	2	116	80	889	0	1522	SW		CALCARIA	BNA	0	0	0	FRAG ALTERAT	1991	S	
263	557	C	2	117	152	958	0	1549	NE		CALCARIA	BPI	0	0	0		1991	S	
263	557	C	2	119	551	642	0	1554	W		QUARS	BNA	0	0	0	FRAG	1991	S	
263	557	C	2	120	97	21	0	1541	W		CERAMICA	INFORME	0	0	0		1991	S	
263	557	C	2	121	187	105	0	1558	P		INDET	BNA	0	0	0	FRAG	1991	S	
263	557	C	2	122	19	178	0	1549	W		RMI	BNA	0	0	0	FRAG	1991	S	
263	557	C	2	123	90	172	0	1535	W		QUARS	BNA	0	0	0	FRAG	1991	S	
263	557	C	2	124	154	235	0	1556	S		QUARSITA	BNA	0	0	0	FRAG	1991	S	
263	557	C	2	125	223	281	0	1554	S		QUARS	BNA	0	0	0	FRAG	1991	S	
263	557	C	2	126	33	399	0	1550	S		SORRENCA	BNA	0	0	0	FRAG	1991		
263	557	C	2	127	23	567	0	1598	E		ESQUIST	BNA	0	0	0		1991	S	
263	557	C	2	128	22	493	0	1590	P		CALCARIA	BP	0	0	0		1991	S	
263	557	C	2	129	957	18	0	1561	S		SORRENCA	BPF	0	0	0		1991	S	
263	557	C	2	130	988	18	0	1570	P		SORRENCA	BNA	0	0	0	FRAG	1991	S	
263	557	C	2	131	110	659	0	1561	P		ESQUIST	BNA	0	0	0	FRAG	1991	S	
263	557	C	2	133	186	524	0	1564	P		QUARS	BNA	0	0	0	FRAG	1991	S	
263	557	C	2	134	83	451	0	1564	S		SORRENCA	BNA	0	0	0	FRAG NO RECUPER	1991	S	
263	557	C	2	135	235	455	0	1562	N		CERAMICA	INFORME	0	0	0		1991	S	
263	557	C	2	136	113	346	0	1584	N		CALCARIA	BPI	0	0	0		1991	S	
263	557	C	2	137	202	396	0	1566	S		CONGLOME	BNA	0	0	0	FRAG	1991	S	
263	557	C	2	138	113	346	0	1569	W		INDET	BPI	0	0	0		1991	S	
263	557	C	2	140	155	315	0	1574	V		SORRENCA	BNA	0	0	0	FRAG	1991	S	
263	557	C	2	141	182	358	0	1576	N		QUARS	BNA	0	0	0		1991	S	
263	557	C	2	142	82	263	0	1581	N		QUARS	BNA	0	0	0		1991		
263	557	C	2	143	199	251	0	1574	P		CONGLOME	BNA	0	0	0	FRAG	1991	S	
263	557	C	2	144	262	213	0	1576	W		ESQUIST	BNA	0	0	0	FRAG	1991	S	
263	557	C	2	145	850	645	0	1579	P		QUARSITA	BNA	0	0	0	FRAC	1991	S	
263	557	C	2	146	176	150	0	1580	E		CALCARIA	BPF	0	0	0		1991	S	
263	557	C	2	147	103	24	0	1571	S		QUARS	BNA	0	0	0	FRAG	1991	S	
263	557	C	2	148	211	19	0	1610	P		CERAMICA	INFORME	0	0	0	2 FRAGS	1991	S	
263	557	C	2	149	296	57	0	1576	P		CERAMICA	INFORME	0	0	0		1991	S	
263	557	C	2	150	168	111	0	1578	P		CERAMICA	INFORME	0	0	0		1991	S	
263	557	C	2	151	163	50	0	1600	P		QUARS	BPI	0	0	0		1991	S	
263	557	C	2	152	168	111	0	1611	E		RMI	BNA	0	0	0	FRAG	1991	S	
263	557	C	2	153	27	26	0	1618	V		CERAMICA	INFORME	0	0	0		1991	S	
263	557	C	2	154	119	81	0	1617	NE		QUARSITA	BNA	0	0	0		1991	S	

BOBILA MADURELL  
MAS DURAN  
Objectes Coordinats C5  
Campanya 1991

c	c	C	N										ALTERACIONS	P	D					
uX	uY	O	I	NUM.	X	Y	Zsup	Zinf	ORIENT	PENDENT	MATERIA	OBJECTE	LONG	AMPL	ESPE	OBSERVACIONS	ANY	U	I	
a	a	N	V															N	B	
d	d	J																	T	U
263	557	c	2		155	173	172	0	1600	S	QUARS	BNA	0	0	0	FRAG	1991	S		
263	557	c	2		156	122	211	0	1591	E	SORRENCA	BNA	0	0	0	FRAG	1991	S		
263	557	c	2		157	48	209	0	1652	S	CERAMICA	INFORME	0	0	0		1991	S		
263	557	c	2		158	54	83	0	1639	P	CERAMICA	INFORME	0	0	0		1991	S		
263	557	c	2		159	234	123	1623	1727	S	SORRENCA	BNA	0	0	0	FRAG	1991	S		
263	557	c	2		160	130	240	0	1697	S	QUARS	BN2G	0	0	0		1991	S		
263	557	c	3		161	760	242	0	1685	S	CALCARIA	BP	0	0	0		1991	S		
263	557	c	3		162	987	228	0	1692	P	CERAMICA	INFORME	0	0	0		1991	S		
263	557	c	3		163	445	811	0	1760	V	QUARS	BNA	0	0	0	FRAG	1991	S		
263	557	c	3		164	39	96	0	1812	S	QUARS	BNA	0	0	0	FRAG	1991	S		
263	557	c	3		165	18	153	0	1805	S	CERAMICA	INFORME	0	0	0	2 FRAGS	1991	S		
263	557	c	3		166	860	33	0	1820	S	QUARS	BPI	0	0	0		1991	S		
263	557	c	3		167	361	802	0	2022	P	CERAMICA	PANXA	0	0	0		1991	S		
263	557	c	3		168	564	827	0	2022	P	QUARS	BPI	0	0	0		1991	S		
263	557	c	3		169	556	344	0	2061	NE	CALCARIA	BNA	0	0	0		1991	S		
263	557	c	3		170	415	346	0	2071	P	CERAMICA	INFORME	0	0	0		1991	S		
263	557	c	3		171	34	71	0	0	W	QUARS	BNA	0	0	0	FRAG	1991	S		
263	557	c	3		172	943	438	2012	2060		SORRENCA	BNA	0	0	0	FRAG	1991	S		
263	557	c	3		173	498	33	0	2112	N	CALCARIA	BNA	0	0	0	FRAC	1991	S		
263	557	c	3		174	568	33	0	2122	S	QUARS	BNA	0	0	0	FRAC	1991	S		
263	557	c	3		175	967	806	0	2208	P	OS	INDET	0	0	0		1991	S		
263	557	c	3		176	839	716	0	2218	SW	CERAMICA	INFORME	0	0	0		1991	S		
263	557	c	3		177	893	692	0	2229	S	RMI	BNA	0	0	0	FRAG	1991	S		
263	557	c	3		178	580	652	0	2186	SW	RMI	BNA	0	0	0	FRAG/'BNE?	1991	S		
263	557	c	3		179	748	554	0	2213	NE	QUARS	BNA	0	0	0		1991	S		
263	557	c	3		180	430	7	0	2200	P	QUARS	BPI	0	0	0		1991	S		
263	557	c	3		181	754	561	0	2206	W	OS	INDET	0	0	0		1991	S		
263	557	c	3		182	991	647	0	2213	S	OS	INDET	0	0	0		1991	S		
263	557	c	3		183	912	969	0	2233	NW	RMI	BNA	0	0	0	FRAG	1991	S		
263	557	c	3		184	900	901	0	2222	SW	CERAMICA	VORA	0	0	0		1991	S		
263	557	c	3		185	836	882	0	2241	SW	RMI	BNA	0	0	0	FRAG	1991	S		
263	557	c	3		186	713	807	0	2235	W	QUARSITA	BNA	0	0	0	FRAG	1991	S		
263	557	c	3		187	873	822	0	2244	P	CALCARIA	BNA	0	0	0	FRAG ALTERAT	1991	S		
263	557	c	3		188	900	696	0	2247	P	CONGLOME	BNA	0	0	0	MICROCONGLOME	1991	S		
263	557	c	3		189	860	647	0	2231	W	RMI	BNA	0	0	0	FRAG	1991	S		
263	557	c	3		190	194	125	0	2230	W	CERAMICA	INFORME	0	0	0		1991	S		
263	557	c	3		191	874	948	0	2248	E	CERAMICA	INFORME	0	0	0		1991	S		
263	557	c	3		192	944	966	0	2245	SW	CONGLOME	BNA	0	0	0	MICROCONGLOME	1991	S		
263	557	c	3		193	990	936	0	2260	SE	CERAMICA	INFORME	0	0	0		1991	S		
263	557	c	3		194	939	904	0	2261	SE	RMI	BNA	0	0	0	FRAG	1991	S		
263	557	c	3		195	687	729	0	2285	SW	QUARS	BNA	0	0	0	FRAG	1991	S		
263	557	c	3		196	800	727	0	2289	N	RMI	BNA	0	0	0		1991	S		
263	557	c	3		197	844	732	0	2267	P	CERAMICA	INFORME	0	0	0		1991	S		
263	557	c	3		198	849	787	0	2293	SW	CALCARIA	BNA	0	0	0	ALTERAT	1991	S		
263	557	c	3		199	934	766	0	2272	P	RMI	BNA	0	0	0	FRAG	1991	S		
263	557	c	3		200	932	838	0	2280	P	RMI	BNA	0	0	0	FRAG	1991	S		
263	557	c	3		201	938	949	0	2280	SE	CONGLOME	BNA	0	0	0	FRAG/MICROCONGL	1991	S		
263	557	c	3		202	674	697	0	2314	P	RMI	BNA	0	0	0	FRAG	1991	S		
263	557	c	3		203	914	828	0	2295	NW	CERAMICA	INFORME	0	0	0		1991	S		
263	557	c	3		204	950	853	0	2296	NW	RMI	BNA	0	0	0	FRAG	1991	S		











BOBILA MADURELL  
MAS DURAN  
Objectes Coordenats C5  
Campanya 1991

c	c	C	N	NUM.	X	Y	Zsup	Zinf	ORIENT	PENDENT	MATERIA	OBJECTE	LONG	AMPL	ESPE	ALTERACIONS	OBSERVACIONS	P	D	
uX	uY	O	I															ANY	U	I
a	a	N	V																N	B
d	d	J																	T	U
263	558	C	2	182	38	891	0	1540	NW		SORRENCA	BNA	0	0	0	FRAG		1991	S	
263	558	C	2	183	98	829	0	1544	V		QUARS	BNA	0	0	0	FRAG		1991	S	
263	558	C	2	184	258	782	0	1523	W		CERAMICA	VORA	0	0	0			1991	S	
263	558	C	2	185	848	678	0	1518	P		OCRE	FRAG	0	0	0	2 FRAGS		1991	S	
263	558	C	2	186	211	353	0	1533	V		SORRENCA	BNA	0	0	0	FRAG		1991	S	
263	558	C	2	187	504	98	0	1529	SE		QUARS	BNA	0	0	0	FRAG		1991	S	
263	558	C	2	188	166	765	0	1550	V		SORRENCA	BNA	0	0	0	FRAG ALTERAT		1991	S	
263	558	C	2	189	122	731	0	1546	V		QUARS	BNA	0	0	0	FRAG		1991	S	
263	558	C	2	190	186	336	0	1555	E		SORRENCA	BNA	0	0	0	FRAG		1991	S	
263	558	C	2	191	135	301	0	1550	P		ESQUIST	BNA	0	0	0	FRAG		1991	S	
263	558	C	2	192	115	127	0	1563	P		SORRENCA	BNA	0	0	0	FRAG		1991	S	
263	558	C	2	193	597	135	0	1549	P		QUARS	BNA	0	0	0			1991	S	
263	558	C	2	194	881	288	1400	1620	SE		CONGLOME	BNE	0	0	0	MOLI FRAG		1991	S	
263	558	C	2	195	947	333	0	1570	SE		QUARS	BNA	0	0	0	FRAG		1991	S	
263	558	C	2	196	25	969	0	1574	SE		SORRENCA	BNA	0	0	0	FRAC		1991		
263	558	C	2	197	322	831	0	1580	P		CERAMICA	INFORME	0	0	0			1991		
263	558	C	2	198	269	720	0	1578	W		SORRENCA	BNA	0	0	0			1991		
263	558	C	2	199	490	252	0	1581	S		CONGLOME	BNA	0	0	0	MICROCON FRAC		1991		
263	558	C	2	200	603	231	0	1578	P		GRANIT	BNA	0	0	0	FRAC		1991		
263	558	C	2	201	205	702	0	1600	SE		SORRENCA	BP	0	0	0			1991		
263	558	C	2	202	245	703	0	1605	N		CERAMICA	VORA	0	0	0			1991		
263	558	C	3	203	68	926	0	1625	SE		SORRENCA	BNA	0	0	0	FRAG		1991	S	
263	558	C	3	204	221	721	0	1605	P		QUARS	BPI	0	0	0			1991	S	
263	558	C	3	205	71	673	0	1865	P		CALCARIA	BPF	0	0	0			1991	S	
263	558	C	3	206	710	36	0	2116	E		CERAMICA	INFORME	0	0	0			1991	S	
263	558	C	3	208	930	56	0	2230	P		CALCARIA	BPI	0	0	0			1991	S	
263	558	C	3	209	961	34	0	0			CALCARIA	BNA	0	0	0			1991	S	
263	559	C		1	737	129	0	0	P		CALCARIA	FRAG	0	0	0			1991		
263	559	C		2	553	269	0	0	NE-SW	SW	CALCARIA	CODOL	0	0	0			1991		
263	559	C		3	737	129	0	0			CERAMICA	INFORME	0	0	0			1991	S	
263	559	C		4	553	269	0	0	N-S	S	QUARS	BNA	0	0	0	FRAG		1991		
263	559	C		5	319	294	0	0	NE-SW	SE	OS	INDET	0	0	0			1991	S	
263	559	C		6	182	355	0	0	N-S	P	QUARS	BNA	0	0	0	FRAG		1991	S	
263	559	C		7	63	372	0	0	NW-SE	SE	SORRENCA	BNA	0	0	0			1991	S	
263	559	C		8	928	492	0	1316	P		QUARS	BPI	0	0	0			1991	S	
263	559	C		9	302	801	0	1377	W		SORRENCA	BNA	0	0	0	FRAG		1991	S	
263	559	C		10	954	540	0	1280	V		SORRENCA	BNA	0	0	0	FRAG		1991	S	
263	559	C		11	768	533	0	1250	E		SORRENCA	BNA	0	0	0	FRAG		1991	S	
263	559	C		12	605	405	0	1260	SE		QUARS	BNA	0	0	0			1991	S	
263	559	C		13	796	713	0	1259	S		SORRENCA	BNA	0	0	0	FRAG ALTERAT		1991		
263	559	C		14	742	832	0	1250	P		CONGLOME	BNA	0	0	0	FRAG		1991	S	
263	559	C		15	942	840	0	1255	P		SORRENCA	BNA	0	0	0	FRAG		1991	S	
263	559	C		16	869	14	0	1297	N		ESQUIST	BNA	0	0	0			1991	S	
263	559	C	2	17	239	484	0	1289	V		SORRENCA	BNA	0	0	0	FRAG		1991	S	
263	559	C	2	18	190	330	0	1314	S		CALCARIA	BN1G	0	0	0			1991	S	
263	559	C	2	19	493	443	0	1307	S		CONGLOME	BNA	0	0	0	FRAG		1991	S	
263	559	C	2	20	528	577	0	1280	SW		CONGLOME	BNA	0	0	0	FRAG		1991	S	
263	559	C	2	21	489	515	0	1299	W		CONGLOME	BNA	0	0	0	FRAG		1991	S	
263	559	C	2	22	578	587	0	1274	SW		CONGLOME	BNA	0	0	0	FRAG		1991	S	
263	559	C	2	23	0	0	0	1288	SW		SORRENCA	FRAG	0	0	0			1991	S	









BOBILA MADURELL  
MAS DURAN  
Objectes Coordenats C5  
Campanya 1991

c uX a d	c uY a d	C O I N V J	N UM.	X	Y	Zsup	Zinf	ORIENT	PENDENT	MATERIA	OBJECTE	LONG	AMPL	ESPE	ALTERACIONS	P D U I B U T	
															OBSERVACIONS		ANY
263	559	C 3	183	652	802	1905	1953	NW	INDET	BNA	0	0	0	ALTERAT	1991	S	
263	559	C 3	184	350	976	0	1926	V	CERAMICA	INFORME	0	0	0		1991	S	
263	559	C 3	185	248	764	0	1927		ORGANIC	CARBO	0	0	0		1991	S	
263	559	C 3	186	62	181	1890	1932	NE	CONGLOME	BNA	0	0	0	MICROCONGL	FRAG	1991	S
263	559	C 3	187	222	721	0	2970	SW	CERAMICA	VORA	0	0	0		1991	S	
263	560	C	1	859	60	0	1265	V	SORRENCA	BNA	0	0	0	FRAG	1991	S	
263	560	C	2	643	272	0	1122	P	CERAMICA	INFORME	0	0	0		1991	S	
263	560	C	3	787	462	0	1214	SE	SORRENCA	BNA	0	0	0	FRAG	1991	S	
263	560	C	4	668	523	0	1200	SW	CERAMICA	VORA	0	0	0		1991	S	
263	560	C 2	5	983	93	0	1280	P	RMI	BNA	0	0	0	FRAG	1991	S	
263	560	C 2	6	880	186	0	1255	P	CERAMICA	INFORME	0	0	0		1991	S	
263	560	C 2	7	787	217	0	1245	S	CERAMICA	INFORME	0	0	0		1991	S	
263	560	C 2	8	812	114	0	1280	P	CONGLOME	BNA	0	0	0	FRAG	1991	S	
263	560	C 2	9	774	130	0	1294	N	CALCARIA	BN1G	0	0	0		1991	S	
263	560	C 2	10	977	21	0	1288	W	QUARS	BNA	0	0	0	FRAG	1991	S	
263	560	C 2	11	982	75	0	1345	P	RMI	BNA	0	0	0	FRAG	1991	S	
263	560	C 2	12	946	144	0	1344	P	RMI	BNA	0	0	0	FRAG	1991	S	
263	560	C 2	13	819	245	0	1333	SE	OS	DET	0	0	0		1991	S	
263	560	C 2	14	986	234	0	1374	P	QUARS	BNA	0	0	0	FRAG	1991	S	
263	560	C	15	64	217	0	1192	N	RMI	BNA	0	0	0	FRAG	1991	S	
263	560	C 2	16	995	56	0	1401	P	CERAMICA	INFORME	0	0	0		1991	S	
263	560	C 2	17	992	17	0	1409	SE	QUARS	BNA	0	0	0	FRAC	1991	S	
263	560	C 3	18	746	706	0	1387	P	CERAMICA	INFORME	0	0	0		1991	S	
264	554	C	1	839	625	1400	1415	E	SILEX	BPF	0	0	0		1991	S	
264	554	C	2	837	469	1355	1434	E	RMI	BNA	0	0	0	FRAG	1991	S	
264	554	C	3	813	390	0	1420	E	CERAMICA	INFORME	0	0	0	ARGILA	CUITA	1991	S
264	554	C	4	366	340	1390	1395	S	CERAMICA	INFORME	0	0	0		1991	S	
264	554	C	5	353	423	0	1400	E	CERAMICA	INFORME	0	0	0		1991	S	
264	554	C	6	354	307	1400	1420	S	CERAMICA	INFORME	0	0	0		1991	S	
264	554	C	7	451	416	1403	1414	E	CERAMICA	INFORME	0	0	0		1991	S	
264	554	C	8	933	395	1477	1492	SW	RMI	BNA	0	0	0	FRAG	1991	S	
264	554	C	9	651	603	0	1420		RMI	BNA	0	0	0	FRAC	1991	S	
264	554	C	10	926	836	0	1400		RMI	BNA	0	0	0		1991	S	
264	554	C	11	727	850	0	1414		CALCARIA	BNA	0	0	0	FRAC	1991	S	
264	554	C	12	16	786	0	1374		TOVOT	FRAG	0	0	0		1991	S	
264	554	C	13	239	881	0	1405		SORRENCA	BNA	0	0	0		1991	S	
264	554	C	14	19	894	0	1389		RMI	BNA	0	0	0		1991	S	
264	554	C	15	81	889	0	1396		CERAMICA	INFORME	0	0	0		1991	S	
264	554	C	16	343	883	0	1418		CERAMICA	INFORME	0	0	0		1991	S	
264	554	C	17	470	858	0	1402		CERAMICA	INFORME	0	0	0		1991		
264	554	C	18	555	889	0	1415		SILEX	BP2G	0	0	0		1991		
264	554	C	19	252	934	0	1425		SILEX	BNA	0	0	0		1991	S	
264	554	C	20	954	956	0	1427		CERAMICA	INFORME	0	0	0		1991		
264	554	C	21	75	726	0	1445	NW	RMI	BNA	0	0	0		1991	S	
264	554	C	22	800	796	0	1465	N	CALCARIA	BNA	0	0	0		1991	S	
264	554	C	23	630	878	0	1450	P	CONGLOME	BNA	0	0	0	MICROCONGLOME	1991	S	
264	554	C	24	405	750	0	1490	P	SILEX	BPF	0	0	0		1991	S	
264	554	C	25	686	901	0	1510	N	CERAMICA	INFORME	0	0	0		1991	S	
264	554	C	26	557	846	0	1526	E	RMI	BNA	0	0	0	FRAG	1991	S	
264	554	C	27	730	900	0	1521		QUARS	BPI	0	0	0		1991	S	

BOBILA MADURELL  
MAS DURAN  
Objectes Coordinats C5  
Campanya 1991

c	c	C	N	NUM.	X	Y	Zsup	Zinf	ORIENT	PENDENT	MATERIA	OBJECTE	LONG	AMPL	ESPE	ALTERACIONS	P	D	
																OBSERVACIONS			ANY
uX	uY	O	I																
a	a	N	V																
d	d	J																	
264	554	C		28	738	951		0	1535	S	RMI	BNA	0	0	0	FRAG	1991	S	
264	554	C		29	535	907		0	1573		SILEX	BN2G	0	0	0		1991	S	
264	554	C		30	560	762		0	1599	N	CERAMICA	INFORME	0	0	0		1991	S	
264	554	C		31	303	790		0	1669	N	CONGLOME	BNA	0	0	0	FRAG NO RECUPER	1991		
264	554	C		32	936	878		0	1673		OS	INDET	0	0	0		1991	S	
264	554	C		33	641	833		0	1696	V	QUARS	BNA	0	0	0		1991	S	
264	554	C		34	598	810		0	1698	V	RMI	BNA	0	0	0	FRAG	1991	S	
264	554	C		35	801	758		0	1735	V	CONGLOME	BNA	0	0	0	FRAG NO RECUPER	1991		
264	554	C		36	299	788		0	1710	N	RMI	BNA	0	0	0	FRAG	1991	S	
264	554	C		37	864	876		0	1731	W	QUARS	BPI	0	0	0		1991	S	
264	554	C		38	871	872		0	1858	W	QUARS	BNA	0	0	0	FRAG	1991	S	
264	554	C		39	505	909		0	1755	P	INDET	BNA	0	0	0	FRAG	1991	S	
264	554	C		40	735	751		0	1838	V	RMI	BNA	0	0	0	FRAG	1991	S	
264	554	C		41	812	903		0	1850		CERAMICA	INFORME	0	0	0		1991		
264	554	C		42	939	731		0	1844	P	ESQUIST	BNA	0	0	0	FRAG	1991	S	
264	554	C		43	935	722		0	1883	W	TOVOT	FRAG	0	0	0		1991	S	
264	554	C		44	666	772		0	1928	N	CERAMICA	PANXA	0	0	0		1991	S	
264	554	C		45	750	751		0	1988		ORGANIC	CARBO	0	0	0		1991	S	
264	554	C		46	749	916		0	2011	NE	OS	DET	0	0	0		1991	S	
264	554	C		47	536	623		0	1977	W	RMI	BNA	0	0	0	FRAG	1991	S	
264	554	C		48	442	588		0	2040	NW	QUARS	BNA	0	0	0	FRAG	1991	S	
264	554	C		49	948	880		0	2032	N	RMI	BNA	0	0	0	FRAG	1991	S	
264	554	C	3	50	819	923		0	2055		ORGANIC	CARBO	0	0	0		1991	S	
264	554	C	3	51	542	961		0	2121	V	TOVOT	FRAG	0	0	0		1991	S	
264	554	C	3	52	433	761		0	2114	N	CERAMICA	INFORME	0	0	0		1991	S	
264	554	C	3	53	497	744		0	2104	V	CALCARIA	BNA	0	0	0	ALTERAT	1991	S	
264	554	C	3	54	751	759		0	2112	NW	QUARS	BNA	0	0	0	FRAG ALTERAT	1991	S	
264	554	C	3	55	968	951		0	2085	P	RMI	BNA	0	0	0	2 FRAG ALTERAT	1991	S	
264	554	C	3	56	661	761		0	2131	NW	RMI	BNA	0	0	0		1991	S	
264	554	C	3	57	443	992		0	2137	V	CALCARIA	BNA	0	0	0	FRAG	1991	S	
264	554	C	3	58	500	914		0	2193	V	CERAMICA	INFORME	0	0	0		1991	S	
264	554	C	3	59	484	860		0	2184	W	RMI	BNA	0	0	0	FRAG	1991	S	
264	554	C	3	60	622	900		0	2164	S	CERAMICA	INFORME	0	0	0		1991	S	
264	554	C	3	61	648	977		0	2205	P	GRANIT	BNA	0	0	0		1991	S	
264	554	C	3	62	356	994		0	2250	V	CERAMICA	INFORME	0	0	0		1991	S	
264	554	C	3	63	402	987		0	2250	V	CALCARIA	BNA	0	0	0	ALTERAT	1991		
264	554	C	3	64	348	992		0	2305	N	CONGLOME	BNA	0	0	0		1991	S	
264	554	C	3	65	393	953		0	2280	V	SILEX	BPI	0	0	0		1991	S	
264	554	C	3	66	248	976		0	2332	N	QUARS	BNA	0	0	0	FRAG	1991	S	
264	554	C	3	67	337	877		0	2310	NE	QUARS	BNA	0	0	0	FRAG	1991	S	
264	554	C	3	68	254	797		0	2213	N	CONGLOME	BNA	0	0	0	FRAG MICROCONGL	1991	S	
264	554	C	3	69	298	927		0	2360	N	RMI	BNA	0	0	0	FRAG	1991	S	
264	554	C	3	70	502	905		0	2353	W	RMI	BNA	0	0	0	FRAG	1991	S	
264	554	C	3	71	431	817		0	2204	N	CERAMICA	INFORME	0	0	0		1991	S	
264	554	C	3	72	505	778		0	2180	N	RMI	BNA	0	0	0	FRAG	1991	S	
264	554	C	3	73	233	912		0	2380	V	QUARS	BNA	0	0	0	FRAG	1991	S	
264	554	C	3	74	228	720		0	2290	N	CERAMICA	INFORME	0	0	0		1991	S	
264	554	C	3	75	69	953		0	2510	N	QUARS	BNA	0	0	0	FRAG	1991	S	
264	554	C	3	76	48	993		0	2507	NE	CALCARIA	BNA	0	0	0	FRAG	1991	S	
63	264	554	C	3	77	104	922		0	2480	NE	RMI	BNA	0	0	0	FRAG	1991	S

BOBILA MADURELL  
 MAS DURAN  
 Objectes Coordinats C5  
 Campanya 1991

c c C N												ALTERACIONS			P D						
uX	uY	O	I	NUM.	X	Y	Zsup	Zinf	ORIENT	PENDENT	MATERIA	OBJECTE	LONG	AMPL	ESPE	OBSERVACIONS	ANY	U	I		
a	a	N	V																	N	B
d	d	J																	T	U	
264	555	C		1	803	165		0	1376		E	CERAMICA	INFORME	0	0	0		1991	S		
264	555	C		2	22	237	1359	1365			W	CERAMICA	INFORME	0	0	0		1991	S		
264	555	C		3	37	401	1275	1315			SE	RMI	BNA	0	0	0	FRAG	1991	S		
264	555	C		4	48	743	114	1344			NE	RMI	BNA	0	0	0	FRAG	1991	S		
264	555	C		5	255	80	105	1344			E	RMI	BNA	0	0	0	FRAG	1991	S		
264	555	C		6	311	4		0	1355			CALCARIA	BNA	0	0	0	FRAG	1991	S		
264	555	C		7	374	40		0	1340			CERAMICA	INFORME	0	0	0		1991			
264	555	C		8	516	793		0	1370			SILEX	BN2G	0	0	0		1991	S		
264	555	C		9	37	442		0	1390			CALCARIA	BNA	0	0	0		1991	S		
264	555	C		10	235	847		0	1395			RMI	BNA	0	0	0		1991	S		
264	555	C		11	523	609		0	1412			CALCARIA	BNA	0	0	0	FRAG ALTERAT	1991	S		
264	555	C		12	969	533	1350	1440			V	SORRENCA	BNA	0	0	0		1991	S		
264	555	C		13	480	403		0	1446		V	SORRENCA	BNA	0	0	0		1991	S		
264	555	C		14	983	105		0	1471		N	CERAMICA	INFORME	0	0	0	2 FRAGS	1991	S		
264	555	C		15	863	89		0	1462		N	CALCARIA	BN1G	0	0	0		1991	S		
264	555	C		16	746	202		0	1467			OS	INDET	0	0	0		1991	S		
264	555	C		17	738	123		0	1512		NW	OS	INDET	0	0	0		1991	S		
264	555	C		18	761	162		0	1510			CERAMICA	INFORME	0	0	0		1991	S		
264	555	C		19	641	229		0	1496		P	CERAMICA	INFORME	0	0	0		1991	S		
264	555	C		20	632	270		0	1503		N	CERAMICA	INFORME	0	0	0		1991	S		
264	555	C		21	999	166		0	1522		P	CALCARIA	BP	0	0	0		1991	S		
264	555	C		22	950	308		0	1524		E	RMI	BNA	0	0	0		1991	S		
264	555	C		23	954	441		0	1510		P	OS	INDET	0	0	0		1991	S		
264	555	C		24	960	902		0	1532		W	QUARS	BNA	0	0	0	FRAG	1991	S		
264	555	C		25	267	805		510			N	RMI	BNA	0	0	0	FRAG	1991	S		
264	555	C		26	183	740		489			P	QUARS	BNA	0	0	0		1991	S		
264	555	C		27	45	619		490			NE	RMI	BNA	0	0	0	FRAG	1991	S		
264	555	C		28	243	265		1525			P	OS	DET	0	0	0		1991	S		
264	555	C		29	379	167		0	1510		P	CERAMICA	VORA	0	0	0		1991	S		
264	555	C		30	936	48		0	1515		N	QUARSITA	BPI	0	0	0		1991	S		
264	555	C		31	379	167		0	1525		P	CERAMICA	VORA	0	0	0		1991	S		
264	555	C		32	125	210		0	1515		N	CERAMICA	INFORME	0	0	0		1991	S		
264	555	C		33	255	309		0	1541		N	QUARSITA	BNA	0	0	0	FRAG	1991	S		
264	555	C		34	485	333		0	1535		N	QUARS	BNA	0	0	0	FRAG	1991	S		
264	555	C		35	688	183		0	1550		E	OS	DET	0	0	0		1991	S		
264	555	C		36	495	333		0	1555		P	SORRENCA	BNA	0	0	0	ALTERAT	1991	S		
264	555	C		37	226	534		0	1542		NW	CALCARIA	BP	0	0	0		1991	S		
264	555	C		38	99	879		0	1510		P	RMI	BNA	0	0	0		1991	S		
264	555	C		39	462	27		0	1505		S	QUARS	BNA	0	0	0	FRAG	1991	S		
264	555	C		40	252	15		0	1513		S	CERAMICA	INFORME	0	0	0		1991	S		
264	555	C		41	176	217		0	1515		NE	RMI	BNA	0	0	0		1991	S		
264	555	C		42	77	322		0	1520		E	INDET	BNA	0	0	0		1991	S		
264	555	C		43	52	753		0	1485		N	GRANIT	BNA	0	0	0	FRAG	1991	S		
264	555	C		44	65	868		0	1483		N	CALCARIA	BNA	0	0	0	FRAC	1991	S		
264	555	C		45	72	62		0	1518		P	QUARS	BNA	0	0	0	FRAG	1991	S		
264	555	C		46	421	541		0	1542		N	CERAMICA	INFORME	0	0	0		1991	S		
264	555	C		47	773	632		0	1546		P	INDET	BNA	0	0	0	NO RECUPERAT	1991	S		
264	555	C		48	674	734		0	1552		P	OS	DET	0	0	0		1991	S		
264	555	C		49	918	329		0	1541			SILEX	BP	0	0	0		1991	S		
264	555	C		50	885	846		0	1524		P	OS	DET	0	0	0		1991	S		

BOBILA MADURELL  
MAS DURAN  
Objectes Coordinats C5  
Campanya 1991

c	c	C	N	NUM.	X	Y	Zsup	Zinf	ORIENT	PENDENT	MATERIA	OBJECTE	LONG	AMPL	ESPE	ALTERACIONS OBSERVACIONS	P	D	
uX	uY	O	I														ANY	U	I
a	a	N	V															N	B
d	d	J																T	U
264	555	C	2	51	154	55	0	1572	P		RMI	BNA	0	0	0	FRAG	1991	S	
264	555	C	2	52	126	208	0	1582	N		RMI	BNA	0	0	0		1991	S	
264	555	C	2	53	78	822	0	1525	NW		SORRENCA	BNA	0	0	0	FRAG	1991	S	
264	555	C	2	54	289	106	0	1585	N		CERAMICA	VORA	0	0	0		1991	S	
264	555	C	2	56	769	200	0	1576	P		SORRENCA	BNA	0	0	0		1991	S	
264	555	C	2	57	49	462	0	1555	P		CALCARIA	BNA	0	0	0		1991	S	
264	555	C	2	58	24	555	1518	1618	NW		RMI	BNA	0	0	0	FRAG	1991	S	
264	555	C	2	59	732	221	0	1582			INDET	FRAG	0	0	0		1991		
264	555	C	2	60	70	857	0	1598			OS	DET	0	0	0		1991	S	
264	555	C	2	61	166	880	0	1588	NE		OS	DET	0	0	0		1991	S	
264	555	C	2	62	218	882	0	1588	P		CALCARIA	BPF	0	0	0		1991	S	
264	555	C	2	63	263	828	0	1595			OS	DET	0	0	0		1991	S	
264	555	C	2	64	375	893	0	1580	W		RMI	BNA	0	0	0	FRAG	1991	S	
264	555	C	2	65	531	847	0	1596	NE		CERAMICA	INFORME	0	0	0	AMB TERRA CUITA	1991	S	
264	555	C	2	66	19	686	0	1613	N		CERAMICA	INFORME	0	0	0		1991	S	
264	555	C	2	67	531	847	0	1620	P		OS	DET	0	0	0		1991	S	
264	555	C	2	68	736	769	0	1607	P		SORRENCA	BNA	0	0	0	FRAG	1991	S	
264	555	C	2	69	861	776	0	1630	P		RMI	BNA	0	0	0		1991	S	
264	555	C	2	70	796	672	0	1622	N		RMI	BNA	0	0	0	FRAG	1991	S	
264	555	C	2	71	830	561	0	1617	N		SORRENCA	BNA	0	0	0	FRAG	1991	S	
264	555	C	2	72	764	466	0	1635	V		CALCARIA	BNA	0	0	0	FRAC	1991	S	
264	555	C	2	73	833	436	0	1615	W		RMI	BNA	0	0	0	FRAG	1991	S	
264	555	C	2	74	871	378	0	1615	N		SORRENCA	BNA	0	0	0	FRAG	1991	S	
264	555	C	2	76	935	251	0	1620	V		QUARS	BNA	0	0	0	FRAG	1991	S	
264	555	C	2	77	736	226	0	1607	W		CERAMICA	INFORME	0	0	0		1991		
264	555	C	2	78	735	232	0	1618			SILEX	BN2G	0	0	0		1991	S	
264	555	C	2	79	313	207	0	1610	W		RMI	BNA	0	0	0		1991	S	
264	555	C	2	80	261	352	0	1627	P		CALCARIA	BP	0	0	0		1991	S	
264	555	C	2	81	152	377	0	1627	P		QUARS	BNA	0	0	0	FRAG	1991	S	
264	555	C	2	82	178	585	0	1606			OS	INDET	0	0	0		1991	S	
264	555	C	2	83	787	518	0	1636	P		RMI	BNA	0	0	0	FRAG	1991	S	
264	555	C	2	84	824	528	0	1648	V		QUARS	FRAG	0	0	0	NO RECUPERAT	1991	S	
264	555	C	2	85	974	752	0	1635	V		CERAMICA	INFORME	0	0	0		1991	S	
264	555	C	2	86	984	703	0	1644	W		CERAMICA	INFORME	0	0	0		1991	S	
264	555	C	2	87	0	0	0	1637	P		SILEX	BPI	0	0	0		1991	S	
264	555	C	2	88	984	703	0	1623	N		CERAMICA	INFORME	0	0	0		1991	S	
264	555	C	2	89	819	840	0	1650	S		QUARS	BNA	0	0	0	FRAG	1991	S	
264	555	C	2	90	716	276	0	1643	N		SILEX	BPI	0	0	0		1991	S	
264	555	C	2	91	0	0	0	1635	V		SILEX	BPF	0	0	0		1991	S	
264	555	C	2	92	655	348	0	1645	V		SILEX	BP	0	0	0		1991	S	
264	555	C	2	93	563	352	0	1642	W		CERAMICA	INFORME	0	0	0		1991	S	
264	555	C	2	94	596	387	0	1645	P		QUARS	BPI	0	0	0		1991	S	
264	555	C	2	96	598	389	0	1659	V		RMI	BNA	0	0	0	FRAG	1991	S	
264	555	C	2	97	923	774	0	1655	P		SORRENCA	BNA	0	0	0	FRAG	1991	S	
264	555	C	2	98	33	753	0	1670	P		RMI	BNA	0	0	0	FRAG	1991	S	
264	555	C	2	99	719	722	0	1673	N		RMI	BNA	0	0	0		1991	S	
264	555	C	2	100	0	0	1595	1690	P		CALCARIA	BNA	0	0	0	NO RECUPERAT	1991	S	
264	555	C	2	101	319	534	0	1673	N		CERAMICA	INFORME	0	0	0		1991	S	
264	555	C	2	102	116	548	0	1702	NW		QUARS	BNA	0	0	0	NO RECUPERAT	1991	S	
264	555	C	2	103	170	585	0	1705	N		CERAMICA	INFORME	0	0	0		1991	S	

BOBILA MADURELL  
MAS DURAN  
Objectes Coordinats C5  
Campanya 1991

c	c	C	N	NUM.	X	Y	Zsup	Zinf	ORIENT	PENDENT	MATERIA	OBJECTE	LONG	AMPL	ESPE	ALTERACIONS	OBSERVACIONS	P	D
uX	uY	O	I															ANY	U
a	a	N	V															N	B
d	d	J																T	U
264	555	C	2	104	461	534	0	1696	P		RMI	BNA	0	0	0	FRAG		1991	S
264	555	C	2	105	474	648	0	1696	V		CERAMICA	APLICA	0	0	0			1991	S
264	555	C	2	106	536	658	0	1704	NE		QUARS	BNA	0	0	0	NO RECUPERAT		1991	S
264	555	C	2	107	697	507	0	1706	N		CERAMICA	INFORME	0	0	0			1991	S
264	555	C	2	108	977	559	0	1694	V		CALCARIA	CODOL	0	0	0			1991	S
264	555	C	2	109	939	786	0	1690	P		SORRENCA	BNA	0	0	0	NO RECUPERAT		1991	S
264	555	C	2	110	739	845	0	1703	W		CALCARIA	BP	0	0	0			1991	S
264	555	C	2	111	192	129	0	1696	W		SORRENCA	BNA	0	0	0	FRAG NO RECUPER		1991	S
264	555	C	2	112	239	105	0	1696	E		CALCARIA	FRAG	0	0	0			1991	
264	555	C	2	113	337	57	0	1680	P		CALCARIA	BPF	0	0	0			1991	S
264	555	C	2	114	453	11	0	1690	W		QUARS	BNA	0	0	0	FRAG		1991	S
264	555	C	2	115	450	357	0	1698	N		SORRENCA	BNA	0	0	0	NO RECUPERAT		1991	S
264	555	C	2	116	654	423	0	1718	P		QUARS	BNA	0	0	0	FRAG		1991	S
264	555	C	2	117	806	751	0	1719	P		QUARS	BNA	0	0	0	NO RECUPERAT		1991	S
264	555	C	2	118	844	763	0	1715	P		QUARS	BNA	0	0	0	FRAG		1991	S
264	555	C	2	119	391	33	0	1696	SW		SORRENCA	BNA	0	0	0	NO RECUPERAT		1991	S
264	555	C	2	120	529	364	0	1715	N		SORRENCA	BNA	0	0	0	NO RECUPERAT		1991	S
264	555	C	2	121	753	389	0	1720	N		QUARS	BNA	0	0	0	NO RECUPERAT		1991	S
264	555	C	2	122	787	582	0	1716	N		CALCARIA	BN1G	0	0	0			1991	S
264	555	C	2	123	748	676	0	1717	W		CALCARIA	BNA	0	0	0	NO RECUPERAT		1991	S
264	555	C	2	124	518	551	0	1720	N		CALCARIA	BPI	0	0	0			1991	S
264	555	C	2	125	483	585	0	1706	N		CALCARIA	BNA	0	0	0	NO RECUPERAT		1991	S
264	555	C	2	126	459	731	0	1712	SE		CALCARIA	BNA	0	0	0	NO RECUPERAT		1991	S
264	555	C	2	127	407	782	0	1690	SE		QUARS	BPI	0	0	0			1991	S
264	555	C	2	128	341	824	0	1700	N		RMI	BNA	0	0	0	FRAG		1991	S
264	555	C	2	129	744	717	0	1700	P		SILEX	BN2G	0	0	0			1991	S
264	555	C	2	130	341	608	0	1719	N		QUARSITA	BNA	0	0	0	NO RECUPERAT		1991	S
264	555	C	2	131	330	605	0	1716	N		SORRENCA	BNA	0	0	0	NO RECUPERAT		1991	S
264	555	C	2	132	341	608	0	1699	SE		CERAMICA	INFORME	0	0	0			1991	S
264	555	C	2	133	283	525	0	1711	W		RMI	BNA	0	0	0	FRAG		1991	S
264	555	C	2	134	198	505	0	1717	P		QUARS	BNA	0	0	0	NO RECUPERAT		1991	S
264	555	C	2	135	99	527	0	1731	E		QUARS	BNA	0	0	0	FRAG		1991	S
264	555	C	2	136	83	661	0	1700	N		SORRENCA	BNA	0	0	0	NO RECUPERAT		1991	S
264	555	C	2	137	238	576	0	1726	SE		RMI	BNA	0	0	0			1991	S
264	555	C	2	138	83	661	0	1696	P		QUARS	BP2G	0	0	0			1991	S
264	555	C	2	139	50	915	0	1701	E		QUARS	BPI	0	0	0			1991	S
264	555	C	2	140	143	280	0	1732	NE		CERAMICA	INFORME	0	0	0			1991	S
264	555	C	2	141	268	684	0	1725	P		QUARS	BNA	0	0	0	FRAG		1991	S
264	555	C	2	142	453	794	0	1712	P		SORRENCA	BNA	0	0	0	NO RECUPERAT		1991	S
264	555	C	2	143	527	886	0	1700	N		CERAMICA	INFORME	0	0	0			1991	S
264	555	C	2	144	612	902	0	1703	W		INDET	BNA	0	0	0	NO RECUPERAT		1991	S
264	555	C	2	145	713	789	0	1735	P		CALCARIA	BNA	0	0	0	FRAG ALTERAT		1991	S
264	555	C	2	146	773	856	0	1740	N		SORRENCA	BNA	0	0	0	NO RECUPERAT		1991	S
264	555	C	2	147	859	883	0	1719	W		RMI	BNA	0	0	0	FRAG		1991	S
264	555	C	2	148	773	856	0	1746	NE		QUARSITA	BNA	0	0	0	FRAG		1991	S
264	555	C	2	149	859	883	0	1750	P		CERAMICA	INFORME	0	0	0			1991	S
264	555	C	2	150	224	699	0	1737			QUARS	BNA	0	0	0	FRAG		1991	S
264	555	C	2	151	247	718	0	1742			QUARS	BNA	0	0	0	FRAG		1991	S
264	555	C	2	152	167	890	0	1755	NE		RMI	BNA	0	0	0	FRAG		1991	S
264	555	C	2	153	326	840	0	1755	P		CALCARIA	BNA	0	0	0	NO RECUPERAT		1991	S

BOBILA MADURELL  
MAS DURAN  
Objectes Coordinats C5  
Campanya 1991

c	c	C	N											ALTERACIONS	P	D				
wX	uY	O	I	NUM.	X	Y	Zsup	Zinf	ORIENT	PENDENT	MATERIA	OBJECTE	LONG	AMPL	ESPE	OBSERVACIONS	ANY	U	I	
a	a	N	V														N	B		
d	d	J																T	U	
264	555	c	2	154	382	786	0	1744	P		CONGLOME	BNA	0	0	0	NO RECUPERAT	1991	S		
264	555	c	2	155	466	705	0	1733	W		CERAMICA	INFORME	0	0	0		1991	S		
264	555	c	2	156	682	912	0	1720	W		SORRENCA	BNA	0	0	0	NO RECUPERAT	1991	S		
264	555	c	2	157	649	770	0	1736	W		CERAMICA	INFORME	0	0	0		1991	S		
264	555	c	2	158	685	657	0	1735	P		QUARS	BNA	0	0	0	FRAC	1991	S		
264	555	c	2	159	765	750	0	1742	V		QUARS	BNA	0	0	0	FRAG	1991	S		
264	555	c	2	160	941	677	0	1743			INDET	FRAG	0	0	0		1991			
264	555	c	2	161	957	578	0	1730			INDET	BNA	0	0	0	NO RECUPERAT	1991	S		
264	555	c	2	162	932	445	0	1740	SW		QUARSITA	BPI	0	0	0		1991	S		
264	555	c	2	163	933	195	0	1753	E		CALCARIA	BNA	0	0	0	FRAG	1991	S		
264	555	c	2	164	664	423	0	1763	N		QUARS	BNA	0	0	0	FRAG	1991	S		
264	555	c	2	165	534	221	0	1725	NE		RMI	BNA	0	0	0		1991	S		
264	555	c	2	166	498	129	0	1745	N		INDET	BNA	0	0	0	FRAG	1991	S		
264	555	c	2	167	376	231	0	1840	P		SORRENCA	BNA	0	0	0	NO RECUPERAT	1991	S		
264	555	c	2	168	68	152	0	1740			CERAMICA	INFORME	0	0	0		1991			
264	555	c	2	169	393	508	0	1761	NW		ESQUIST	BNA	0	0	0		1991	S		
264	555	c	2	170	342	594	0	1758	N		QUARS	BNA	0	0	0	FRAG	1991	S		
264	555	c	2	171	332	672	0	1770	N		QUARS	BNA	0	0	0	FRAG	1991	S		
264	555	c	2	172	403	650	0	1768	W		INDET	CODOLF	0	0	0		1991	S		
264	555	c	2	173	588	592	0	1764	E		QUARS	BPF	0	0	0		1991	S		
264	555	c	2	174	547	699	0	1750	P		RMI	BNA	0	0	0	FRAG	1991	S		
264	555	c	2	175	589	749	0	1766	W		CONGLOME	BNA	0	0	0	FRAG MICROCONGL	1991	S		
264	555	c	2	176	511	863	0	1760	S		ESQUIST	BNA	0	0	0	FRAG	1991	S		
264	555	c	2	177	511	903	0	1782	S		CALCARIA	BNA	0	0	0		1991	S		
264	555	c	2	179	701	842	0	1756	P		RMI	BNA	0	0	0	FRAG	1991	S		
264	555	c	2	180	672	822	0	1765	W		QUARS	BNA	0	0	0	FRAC	1991	S		
264	555	c	2	181	757	756	0	1764	P		CALCARIA	BNA	0	0	0	ALTERAT	1991	S		
264	555	c	2	182	755	662	0	1769	P		RMI	BNA	0	0	0	FRAG	1991	S		
264	555	c	2	183	749	610	0	1757	W		CERAMICA	INFORME	0	0	0		1991	S		
264	555	c	2	184	806	635	0	1760	W		CERAMICA	VORA	0	0	0		1991	S		
264	555	c	2	185	856	902	0	1757	SW		RMI	BNA	0	0	0	FRAG	1991	S		
264	555	c	2	186	923	756	0	1792	SW		SORRENCA	BNA	0	0	0		1991	S		
264	555	c	2	187	496	267	0	1770	N		SORRENCA	BNA	0	0	0	FRAG	1991	S		
264	555	c	2	188	872	331	0	1765	P		ESQUIST	BNA	0	0	0	FRAG	1991	S		
264	555	c	2	189	837	360	0	1784	P		OS	DET	0	0	0		1991	S		
264	555	c	2	190	743	553	0	1780	N		QUARS	BNA	0	0	0	FRAG	1991	S		
264	555	c	2	191	644	662	0	1779	SW		CERAMICA	INFORME	0	0	0	2 FRAGS	1991	S		
264	555	c	2	192	752	744	0	1790	E		CALCARIA	BNA	0	0	0	FRAG	1991	S		
264	555	c	2	193	459	795	0	1797	SE		RMI	BNA	0	0	0	FRAG	1991	S		
264	555	c	2	194	308	861	0	1795	S		QUARS	BNA	0	0	0	FRAG	1991	S		
264	555	c	2	195	141	765	0	1785	SE		CALCARIA	BNA	0	0	0	FRAG	1991	S		
264	555	c	2	196	262	608	0	1785	P		CALCARIA	BPF	0	0	0		1991	S		
264	555	c	2	197	330	583	0	1785	P		CERAMICA	INFORME	0	0	0		1991	S		
264	555	c	2	198	328	494	0	1781	SW		QUARS	BNA	0	0	0	FRAG	1991	S		
264	555	c	2	199	172	430	0	1782	P		SORRENCA	BNA	0	0	0	FRAG	1991	S		
264	555	c	3	200	969	66	0	1755	NW		CONGLOME	BNA	0	0	0	FRAG	1991	S		
264	555	c	3	201	974	185	0	1762	W		CALCARIA	BNA	0	0	0	FRAG	1991	S		
264	555	c	2	202	948	400	1715	1790	NW		CALCARIA	BNA	0	0	0	FRAG	1991	S		
67	264	555	c	2	203	846	519	1725	1825	NW		CONGLOME	BNA	0	0	0	FRAG MICROCONGL	1991	S	
264	555	c	2	204	868	610	0	1820	N		CALCARIA	BNA	0	0	0	FRAC	1991	S		







BOBILA MADURELL  
MAS DURAN  
Objectes Coordinats C5  
Campanya 1991

c	c	C	N											ALTERACIONS	P	D			
uX	uY	O	I	NUM.	X	Y	Zsup	Zinf	ORIENT	PENDENT	MATERIA	OBJECTE	LONG	AMPL	ESPE	OBSERVACIONS	ANY	U	I
a	a	N	V														N	B	
d	d	J																T	U
264	555	C	2	308	464	357	0	1880	P		CERAMICA	INFORME	0	0	0		1991	S	
264	555	C	2	310	458	630	0	1893	SW		SILEX	BN1G	0	0	0		1991	S	
264	555	C	2	311	433	645	0	1893	SE		SORRENCA	BNA	0	0	0	NO RECUPERAT	1991	S	
264	555	C	2	312	246	825	0	1880	P		RMI	BNA	0	0	0	FRAG	1991	S	
264	555	C	2	313	276	857	0	1874	V		CALCARIA	BP	0	0	0	ALTERAT	1991	S	
264	555	C	2	314	134	650	0	1881	P		SILEX	BPI	0	0	0		1991	S	
264	555	C	2	315	168	258	0	1894	P		QUARS	BNA	0	0	0	FRAG	1991	S	
264	555	C	2	316	412	288	0	1885	SE		RMI	BNA	0	0	0	FRAG	1991	S	
264	555	C	2	317	405	392	0	1907	NE		CONGLOME	BNA	0	0	0	FRAG MICROCONGL	1991	S	
264	555	C	2	318	273	556	0	1901	N		QUARS	BNA	0	0	0	FRAG	1991	S	
264	555	C	2	320	160	556	0	1904	SE		RMI	BNA	0	0	0	FRAG	1991	S	
264	555	C	2	321	359	548	0	1915	N		CERAMICA	INFORME	0	0	0		1991	S	
264	555	C	2	322	305	631	0	1910	V		CONGLOME	BNA	0	0	0	FRAG MICROCONGL	1991	S	
264	555	C	2	323	369	956	0	1735	P		RMI	BNA	0	0	0	FRAG	1991	S	
264	555	C	2	324	250	922	0	1860	P		CONGLOME	BNA	0	0	0	FRAG MICROCONGL	1991	S	
264	555	C	2	325	261	737	0	1900	P		RMI	BNA	0	0	0	FRAG	1991	S	
264	555	C	2	326	145	649	0	1928	V		QUARS	BNA	0	0	0	FRAG	1991	S	
264	555	C	2	327	117	726	0	1890	NW		CONGLOME	BNA	0	0	0	FRAG MICROCONGL	1991	S	
264	555	C	2	328	157	802	0	1896	SE		QUARS	BNA	0	0	0	FRAG	1991	S	
264	555	C	3	330	293	151	0	1900	N		RMI	BNA	0	0	0	FRAG	1991	S	
264	555	C	3	331	326	69	0	1904	N		QUARS	BNA	0	0	0	FRAG	1991	S	
264	555	C	2	332	556	145	0	1900	V		SORRENCA	COOLF	0	0	0		1991	S	
264	555	C	3	333	729	74	0	1888	P		CERAMICA	INFORME	0	0	0	DOS FRAGS	1991	S	
264	555	C	3	334	807	158	0	1889	NW		RMI	BNA	0	0	0	FRAG	1991	S	
264	555	C	2	335	449	550	0	1919	P		QUARS	BNA	0	0	0		1991	S	
264	555	C	2	336	243	564	0	1945	P		RMI	BNA	0	0	0	FRAG	1991	S	
264	555	C	2	337	348	668	0	1926	S		CONGLOME	BNA	0	0	0	FRAG MICROCONGL	1991	S	
264	555	C	3	338	751	230	0	1904	N		SORRENCA	BNA	0	0	0	FRAG	1991	S	
264	555	C	3	339	861	0	0	1870	P		QUARS	BNA	0	0	0		1991	S	
264	555	C	2	340	736	310	0	1942	NE		RMI	BNA	0	0	0		1991	S	
264	555	C	3	341	360	56	0	1930	NE		CALCARIA	BPF	0	0	0		1991	S	
264	555	C	3	342	422	120	0	1935	N		ESQUIST	BNA	0	0	0		1991	S	
264	555	C	2	343	516	357	0	1945	NW		CERAMICA	INFORME	0	0	0		1991	S	
264	555	C	2	344	81	585	0	1930	NW		CALCARIA	BNA	0	0	0	FRAG	1991	S	
264	555	C	2	345	237	678	0	1915	N		QUARSITA	BNA	0	0	0	FRAG	1991	S	
264	555	C	2	346	128	578	0	1950	NE		RMI	BNA	0	0	0	FRAG	1991	S	
264	555	C	2	347	129	679	0	1925	NE		QUARS	BNA	0	0	0		1991	S	
264	555	C	2	348	231	534	0	1958	N		QUARS	BNA	0	0	0	FRAG	1991	S	
264	555	C	2	349	215	759	0	1944	V		CALCARIA	FRAG	0	0	0		1991	S	
264	555	C	2	350	251	737	0	1927	P		OS	DET	0	0	0		1991	S	
264	555	C	2	351	258	768	0	1947	V		RMI	BNA	0	0	0	FRAG	1991	S	
264	555	C	2	352	250	803	0	1934	S		QUARSITA	BNA	0	0	0		1991	S	
264	555	C	2	353	248	860	0	1933	SW		QUARS	BNA	0	0	0		1991	S	
264	555	C	2	354	350	990	0	1872	V		CALCARIA	BNA	0	0	0	FRAG ALTERAT	1991	S	
264	555	C	3	355	407	87	0	1933	V		TOVOT	FRAG	0	0	0		1991	S	
264	555	C	2	356	613	491	0	1950	P		CERAMICA	INFORME	0	0	0		1991	S	
264	555	C	2	357	890	302	0	1920	NW		CALCARIA	BNA	0	0	0	FRAG	1991	S	
264	555	C	2	358	916	319	0	1900	NW		RMI	BNA	0	0	0	FRAG	1991	S	
264	555	C	2	359	972	483	0	1918	NW		QUARS	BNA	0	0	0		1991	S	
264	555	C	2	360	906	731	0	1943	P		RMI	BNA	0	0	0	FRAG	1991	S	

BOBILA MADURELL  
MAS DURAN  
Objectes Coordenats C5  
Campanya 1991

c	c	C	N	NUM.	X	Y	Zsup	Zinf	ORIENT	PENDENT	MATERIA	OBJECTE	LONG	AMPL	ESPE	ALTERACIONS	OBSERVACIONS	P	D
uX	uY	O	I															ANY	U
a	a	N	V															N	B
d	d	J																T	U
264	555	C	3	361	789	248	0	1929	V		CALCARIA	BNA	0	0	0			1991	S
264	555	C	3	362	453	105	0	1955	N		SORRENCA	BNA	0	0	0	FRAG		1991	S
264	555	C	3	363	979	170	0	1930	P		CALCARIA	BNA	0	0	0	FRAG ALTERAT		1991	S
264	555	C	2	364	961	328	0	1924	SW		SORRENCA	BNA	0	0	0			1991	S
264	555	C	2	365	954	539	0	1915	N		CONGLOME	BNA	0	0	0	MICROCONGLOME		1991	S
264	555	C	3	366	502	133	0	1954	P		INDET	BNA	0	0	0			1991	S
264	555	C	2	368	724	379	0	1954	P		SILEX	BN2G	0	0	0			1991	S
264	555	C	2	369	846	323	0	1948	P		QUARSITA	BNA	0	0	0	FRAG		1991	S
264	555	C	3	370	932	270	0	1946	P		QUARS	BNA	0	0	0	FRAG		1991	S
264	555	C	2	371	888	519	0	1952	NW		CONGLOME	BNA	0	0	0	FRAG		1991	S
264	555	C	2	372	907	502	0	1944	E		CONGLOME	BNA	0	0	0	FRAG		1991	S
264	555	C	3	373	865	228	0	1940	W		CONGLOME	BNA	0	0	0	FRAG		1991	S
264	555	C	3	374	911	210	0	1939	P		CONGLOME	BNA	0	0	0	FRAG		1991	S
264	555	C	3	375	250	330	0	1966	N		QUARS	BNA	0	0	0	FRAG		1991	S
264	555	C	3	376	369	145	0	1959	N		CERAMICA	INFORME	0	0	0			1991	S
264	555	C	2	377	764	870	0	1960	P		QUARS	BNA	0	0	0	FRAG		1991	S
264	555	C	3	378	450	103	0	1967	N		RMI	BNA	0	0	0	FRAG		1991	S
264	555	C	3	379	966	149	0	1963	N		CERAMICA	APLICA	0	0	0	LLENGUETA		1991	S
264	555	C	2	380	992	474	0	1933	W		CERAMICA	INFORME	0	0	0			1991	S
264	555	C	2	381	355	860	0	1970	V		CERAMICA	INFORME	0	0	0			1991	S
264	555	C	2	382	373	778	0	1964	N		SORRENCA	BNA	0	0	0	NO RECUPERAT		1991	S
264	555	C	2	383	141	667	0	1985	N		RMI	BNA	0	0	0	FRAG		1991	S
264	555	C	2	384	310	748	0	1993	S		SORRENCA	BNA	0	0	0			1991	S
264	555	C	2	385	607	587	0	1978	E		CERAMICA	INFORME	0	0	0			1991	S
264	555	C	2	386	668	532	0	1997	N		RMI	BNA	0	0	0			1991	S
264	555	C	2	387	772	460	0	1972	NE		RMI	BNA	0	0	0			1991	S
264	555	C	2	388	909	401	0	1979	V		QUARS	BNA	0	0	0	FRAG		1991	S
264	555	C	2	389	996	397	0	1960	S		QUARS	FRAG	0	0	0			1991	S
264	555	C	2	390	997	653	0	1980	W		RMI	BNA	0	0	0	FRAG		1991	S
264	555	C	2	391	902	627	0	1974			CERAMICA	INFORME	0	0	0			1991	S
264	555	C	3	392	718	368	0	1984	NW		SILEX	BPI	0	0	0			1991	S
264	555	C	3	393	565	325	0	1992	NE		CERAMICA	INFORME	0	0	0			1991	S
264	555	C	3	394	409	164	0	1985	NW		CERAMICA	INFORME	0	0	0			1991	S
264	555	C	3	395	860	139	0	1981	NE		RMI	BNA	0	0	0			1991	S
264	555	C	3	396	678	54	0	1984	W		CALCARIA	BNA	0	0	0	FRAC		1991	S
264	555	C	3	397	909	7	0	1992	W		RMI	BNA	0	0	0	FRAG		1991	S
264	555	C	2	398	966	312	0	1986	SW		CERAMICA	INFORME	0	0	0			1991	S
264	555	C	2	399	520	625	1926	2034	P		SORRENCA	BNA	0	0	0	FRAG		1991	S
264	555	C	2	400	699	764	0	1991	P		CALCARIA	BNA	0	0	0	FRAG ALTERAT		1991	S
264	555	C	2	401	443	565	0	2021	NE		CERAMICA	INFORME	0	0	0			1991	S
264	555	C	2	402	823	713	0	2000			OS	DET	0	0	0			1991	S
264	555	C	2	403	201	401	0	2010	P		QUARS	BNA	0	0	0	FRAG		1991	S
264	555	C	2	404	246	267	0	2015	V		QUARS	BNA	0	0	0	FRAG		1991	S
264	555	C	2	405	948	349	0	2015	V		CONGLOME	FRAG	0	0	0			1991	
264	555	C	3	406	805	155	0	2000	N		QUARS	BNA	0	0	0	NO RECUPERAT		1991	S
264	555	C	2	407	749	345	0	1999	W		RMI	BNA	0	0	0	FRAG		1991	S
264	555	C	2	408	772	679	0	2030			OS	INDET	0	0	0			1991	S
264	555	C	2	409	692	732	0	2015	SW		ESQUIST	BNA	0	0	0	FRAG		1991	S
264	555	C	2	410	605	657	0	2022	S		CERAMICA	INFORME	0	0	0			1991	S
264	555	C	2	411	613	632	0	2023	V		QUARS	BNA	0	0	0	NO RECUPERAT		1991	

BOBILA MADURELL  
MAS DURAN  
Objectes Coordenats C5  
Campanya 1991

c	c	C	N	NUM.	X	Y	Zsup	Zinf	ORIENT	PENDENT	MATERIA	OBJECTE	LONG	AMPL	ESPE	ALTERACIONS	OBSERVACIONS	P	D
uX	uY	O	I															ANY	U
a	a	N	V																I
d	d	J																	N
																			B
																			T
																			U
264	555	C	2	412	654	664	0	2016	NW		ESQUIST	BNA	0	0	0			1991	S
264	555	C	2	413	925	521	0	2029	S		CALCARIA	BNA	0	0	0			1991	S
264	555	C	2	414	744	344	0	2022	N		INDET	BNA	0	0	0	ALTERAT		1991	S
264	555	C	2	415	968	327	0	2018	NW		QUARS	BNA	0	0	0	FRAG		1991	S
264	555	C	3	416	617	37	0	2055	V		SORRENCA	BNA	0	0	0			1991	S
264	555	C	2	418	763	442	0	2035	N		SORRENCA	BNA	0	0	0			1991	S
264	555	C	2	419	809	462	0	2030	N		CALCARIA	BNA	0	0	0			1991	S
264	555	C	2	420	966	254	0	2000	NE		CERAMICA	INFORME	0	0	0			1991	S
264	555	C	2	421	929	454	0	2023	E		CALCARIA	BNA	0	0	0	FRAG	ALTERAT	1991	S
264	555	C	2	422	858	636	0	2050	S		CERAMICA	INFORME	0	0	0			1991	S
264	555	C	2	423	740	887	0	2038	W		CERAMICA	INFORME	0	0	0			1991	S
264	555	C	2	424	567	692	0	2038	P		CERAMICA	INFORME	0	0	0	TERRA	CUITA	1991	S
264	555	C	2	425	498	844	0	2022	SE		RMI	BNA	0	0	0	FRAG		1991	S
264	555	C	2	426	438	653	0	2045	V		QUARS	BNA	0	0	0	FRAG		1991	S
264	555	C	2	427	300	532	0	2040	NE		SORRENCA	BNA	0	0	0	FRAG	ALTERAT	1991	S
264	555	C	2	428	225	501	0	2050	V		RMI	BNA	0	0	0	FRAG		1991	S
264	555	C	2	429	111	523	0	2010	S		SORRENCA	BNA	0	0	0	ALTERAT		1991	S
264	555	C	2	430	345	679	0	2052	V		CALCARIA	BNA	0	0	0	FRAG	ALTERAT	1991	S
264	555	C	2	432	562	551	0	2053	N		INDET	BNA	0	0	0	NO	RECUPERAT	1991	S
264	555	C	2	433	227	550	0	2047	NW		OS	DET	0	0	0	VT		1991	S
264	555	C	2	434	768	621	0	2085	W		OS	DET	0	0	0	BA		1991	S
264	555	C	2	435	83	876	0	1690	P		CONGLOME	BNA	0	0	0	MICROCONGLOME		1991	S
264	555	C	2	436	340	979	0	1701	W		QUARS	BPI	0	0	0			1991	S
264	555	C	2	437	83	876	0	1680			SILEX	BPF	0	0	0			1991	S
264	555	C	2	438	448	922	0	1684	P		CALCARIA	BPF	0	0	0			1991	S
264	555	C	2	439	680	970	0	1687	SE		CALCARIA	BPF	0	0	0			1991	S
264	555	C	2	441	299	925	0	1711	NE		QUARS	BPF	0	0	0			1991	S
264	555	C	2	442	499	915	0	1721	N		QUARS	BPF	0	0	0			1991	S
264	555	C	2	443	752	934	0	1701	V		SORRENCA	BNE	0	0	0	ALLISADOR	FRAG	1991	S
264	555	C	2	444	749	909	0	1688	V		CERAMICA	INFORME	0	0	0			1991	S
264	555	C	2	445	554	898	0	1745	NW		SORRENCA	BNA	0	0	0	FRAG		1991	S
264	555	C	2	446	202	944	0	1712	P		CERAMICA	INFORME	0	0	0			1991	S
264	555	C	2	447	370	876	0	1732	V		CALCARIA	BPI	0	0	0			1991	S
264	555	C	2	448	365	924	0	1739	N		CONGLOME	BNA	0	0	0	FRAG		1991	S
264	555	C	2	449	504	927	0	1723	V		CERAMICA	INFORME	0	0	0			1991	S
264	555	C	2	450	552	912	0	1734	V		SILEX	BPF	0	0	0			1991	S
264	555	C	2	451	67	829	0	1738	NE		CALCARIA	BNA	0	0	0	FRAC		1991	S
264	555	C	2	452	148	833	0	1734	W		SORRENCA	BNA	0	0	0			1991	S
264	555	C	2	453	11	978	0	1765	E		SORRENCA	BNA	0	0	0	FRAG		1991	S
264	555	C	2	454	308	931	0	1762	S		CERAMICA	INFORME	0	0	0			1991	S
264	555	C	2	455	515	970	0	1769	S		SORRENCA	BPF	0	0	0			1991	S
264	555	C	2	456	63	953	0	1774	W		RMI	BNA	0	0	0	FRAG		1991	S
264	555	C	2	457	236	986	0	1794	SE		QUARS	BPI	0	0	0			1991	S
264	555	C	2	458	231	990	0	1799	W		CERAMICA	INFORME	0	0	0			1991	S
264	555	C	2	459	37	667	0	1784	SE		CERAMICA	INFORME	0	0	0			1991	S
264	555	C	2	460	31	934	0	1788	P		QUARS	BNA	0	0	0	FRAG		1991	S
264	555	C	2	461	39	535	0	1844	V		CALCARIA	BNA	0	0	0	FRAC		1991	S
264	555	C	2	462	31	974	0	2079	P		QUARS	BNA	0	0	0	FRAG		1991	S
264	555	C	2	463	39	535	0	1843	V		CALCARIA	BPI	0	0	0			1991	S
264	555	C	2	464	552	728	0	1848	P		SORRENCA	BNA	0	0	0	FRAG		1991	S

01/28/92

BOBILA MADURELL  
MAS DURAN  
Objectes Coordenats C5  
Campanya 1991

c	c	C	N	NUM.	X	Y	Zsup	Zinf	ORIENT	PENDENT	MATERIA	OBJECTE	LONG	AMPL	ESPE	ALTERACIONS OBSERVACIONS	P D U I N B T U
uX	uY	O	I														ANY
a	a	N	V														
d	d	J															
264	555	C	2	465	120	896	0	1875	V		CONGLOME	BNA	0	0	0		1991
264	555	C	2	466	151	876	0	1872	V		SORRENCA	BNA	0	0	0	FRAG	1991
264	555	C	2	467	274	889	0	1879	NE		ESQUIST	BNA	0	0	0	FRAG	1991
264	555	C	2	468	66	810	0	1901	NE		SORRENCA	BNA	0	0	0	FRAG	1991
264	555	C	2	469	125	817	0	1891	SE		OS	DET	0	0	0	MD	1991
264	555	C	2	470	209	851	0	1908	V		ESQUIST	BNA	0	0	0	FRAG	1991
264	555	C	2	471	38	712	0	1904	P		ESQUIST	BNA	0	0	0	FRAG	1991
264	555	C	2	472	68	742	1905	1943	P		CONGLOME	BNA	0	0	0	FRAG	1991
264	555	C	2	473	123	768	0	1854	V		CALCARIA	BN1G	0	0	0		1991
264	555	C	2	474	149	727	0	1896	V		SORRENCA	BNA	0	0	0	FRAG	1991
264	555	C	2	475	42	672	0	1881	P		INDET	BNA	0	0	0	FRAG	1991
264	555	C	2	476	86	640	0	1952	P		QUARS	BP	0	0	0		1991
264	555	C	2	477	113	631	0	1985	P		CALCARIA	BN1G	0	0	0		1991
264	555	C	2	478	170	742	0	1953	P		SORRENCA	BNA	0	0	0	FRAG	1991
264	555	C	2	479	164	777	0	1955	NE		CALCARIA	BNA	0	0	0	FRAG	1991
264	555	C	2	480	207	782	0	1974	V		ESQUIST	BNA	0	0	0	FRAG	1991
264	555	C	2	481	124	969	0	1868	V		CERAMICA	INFORME	0	0	0		1991
264	555	C	2	482	241	919	0	1881	V		CALCARIA	BPF	0	0	0		1991
264	555	C	2	483	94	870	0	1905	S		CALCARIA	BNA	0	0	0	FRAG	1991
264	555	C	2	484	120	912	0	1908	W		ESQUIST	BNA	0	0	0	FRAG	1991
264	555	C	2	485	63	762	0	1947	V		CALCARIA	BNA	0	0	0	ALTERAT	1991
264	555	C	2	486	41	934	0	1945	E		CERAMICA	INFORME	0	0	0		1991
264	555	C	2	487	42	657	0	1990	V		GRANIT	BNA	0	0	0	FRAG	1991
264	555	C	2	488	23	740	0	1965	NE		RMI	BNA	0	0	0	FRAG	1991
264	555	C	2	489	63	823	0	1968	V		QUARS	BNA	0	0	0	FRAG	1991
264	555	C	2	490	13	793	0	1995	NE		CALCARIA	BNA	0	0	0	FRAC	1991
264	555	C	2	491	186	848	0	2005	S		QUARS	BNA	0	0	0	FRAG	1991
264	555	C	2	492	204	916	0	2000	V		RMI	BNA	0	0	0	FRAG	1991
264	555	C	2	493	135	703	0	2015	S		RMI	BNA	0	0	0	FRAG	1991
264	555	C	2	494	102	259	0	2010	E		SILEX	BNA	0	0	0	FRAC	1991
264	555	C	2	495	140	735	0	1992	NW		RMI	BNA	0	0	0	FRAG	1991
264	555	C	2	496	117	934	0	1990	S		CERAMICA	INFORME	0	0	0		1991
264	555	C	2	497	150	858	0	1997	S		CERAMICA	INFORME	0	0	0		1991
264	555	C	2	498	463	924	0	2035	S		ESQUIST	BNA	0	0	0	FRAG	1991
264	555	C	2	499	531	994	0	2010	V		SILEX	BNA	0	0	0	FRAC	1991
264	555	C	2	500	170	943	0	2026	V		CONGLOME	BNA	0	0	0	FRAG MICROCONGL	1991
264	555	C	2	501	200	800	0	2051	P		RMI	BNA	0	0	0	FRAC	1991
264	555	C	2	502	148	728	0	2053	S		ESQUIST	BNA	0	0	0	FRAG	1991
264	555	C	2	503	290	827	0	2045	N		CERAMICA	INFORME	0	0	0		1991
264	555	C	2	504	85	366	0	2047	P		ESQUIST	BNA	0	0	0	FRAG	1991
264	555	C	2	505	23	547	0	2065	N		CONGLOME	BNA	0	0	0	FRAG	1991
264	555	C	2	506	275	303	0	2068	N		CALCARIA	BNA	0	0	0	FRAG CREMAT	1991
264	555	C	2	507	222	354	0	2070	N		CALCARIA	BNA	0	0	0	FRAG CREMAT	1991
264	555	C	2	508	180	401	0	2077	NW		RMI	BNA	0	0	0	FRAG	1991
264	555	C	2	509	140	608	0	2075	S		PISSARRA	BNA	0	0	0	FRAG	1991
264	555	C	2	510	86	935	0	2053	E		RMI	BNA	0	0	0	FRAG	1991
264	555	C	2	511	277	775	0	2100	V		CALCARIA	BN1G	0	0	0		1991
264	555	C	2	512	311	659	0	2087	S		CONGLOME	BNA	0	0	0	FRAG	1991
264	555	C	2	513	335	897	0	2077	S		ORGANIC	CARBO	0	0	0		1991
264	555	C	2	514	306	851	0	2106	E		QUARSITA	BNA	0	0	0	FRAC	1991

BOBILA MADURELL  
MAS DURAN  
Objectes Coordenats C5  
Campanya 1991

c	c	C	N										ALTERACIONS	P	D				
uX	uY	O	I	NUM.	X	Y	Zsup	Zinf	ORIENT	PENDENT	MATERIA	OBJECTE	LONG	AMPL	ESPE	OBSERVACIONS	ANY	U	I
a	a	N	V															N	B
d	d	J																T	U
264	555	C	2		515	252	855	0	2105	NW	SILEX	BN2G	0	0	0		1991	S	
264	555	C	2		516	307	728	0	2099	P	CALCARIA	BP	0	0	0	FRAG	1991	S	
264	555	C	2		517	275	633	0	2094	N	RMI	BNA	0	0	0	FRAG	1991	S	
264	555	C	2		518	146	599	0	2086	W	QUARSITA	BNA	0	0	0		1991	S	
264	555	C	2		519	310	435	0	2113	P	CALCARIA	BNA	0	0	0		1991	S	
264	555	C	2		520	368	412	0	2108		RMI	BNA	0	0	0	FRAG	1991	S	
264	555	C	2		521	213	392	0	2109	V	RMI	BNA	0	0	0	FRAG	1991	S	
264	555	C	2		522	185	497	0	2140	V	CERAMICA	APLICA	0	0	0	MUGRO	1991	S	
264	555	C	2		523	109	524	0	2132	V	CERAMICA	APLICA	0	0	0	LLENGUETA	FRAG	1991	S
264	555	C	2		524	50	596	0	2125	SE	CERAMICA	INFORME	0	0	0	ARGILA	CUITA	1991	S
264	555	C	2		525	158	722	0	2150	E	RMI	BNA	0	0	0	FRAC	1991	S	
264	555	C	2		526	228	562	0	2122	S	CALCARIA	BNA	0	0	0	FRAG	1991	S	
264	555	C	2		527	310	603	0	2115	E	SORRENCA	BNA	0	0	0	FRAG	1991	S	
264	555	C	2		528	356	530	0	2140		ORGANIC	CARBO	0	0	0		1991	S	
264	555	C	2		529	72	572	0	2155	V	QUARS	BNA	0	0	0	FRAG	1991	S	3
264	555	C	2		530	83	629	0	2168	V	INDET	BNA	0	0	0	FRAG	1991	S	
264	555	C	2		531	186	635	0	2194	V	QUARS	BNA	0	0	0	FRAG	1991	S	
264	555	C	2		532	208	715	0	2179	P	QUARS	BPI	0	0	0		1991	S	
264	555	C	2		533	239	614	0	2204	P	CERAMICA	INFORME	0	0	0	ARGILA	CUITA	1991	S
264	555	C	2		534	306	506	0	2158	P	OS	INDET	0	0	0		1991	S	
264	555	C	2		535	255	346	0	2160	V	CERAMICA	INFORME	0	0	0	ARGILA	CUITA	1991	S
264	555	C	2		536	148	507	0	2187	P	QUARS	BNA	0	0	0	FRAG	1991	S	
264	555	C	2		537	188	538	0	2195	N	INDET	BNA	0	0	0		1991	S	
264	555	C	2		538	244	570	0	2196	P	CONGLOME	BNA	0	0	0	FRAG	MICROCONGL	1991	S
264	555	C	2		539	131	661	0	2204	V	ESQUIST	BNA	0	0	0	FRAG	1991	S	
264	555	C	2		540	300	598	0	2236	V	CONGLOME	BNA	0	0	0	FRAG	MICROCONGL	1991	S
264	555	C	2		541	0	0	0	2200	P	SILEX	BPI	0	0	0		1991	S	
264	555	C	2		542	299	627	0	2199	S	INDET	BNA	0	0	0	FRAG	1991	S	
264	555	C	2		543	30	544	0	2176		ORGANIC	CARBO	0	0	0	MOLT	GRAN	1991	S
264	555	C	2		544	271	577	0	2207	P	QUARS	BNA	0	0	0	FRAG	1991	S	
264	555	C	2		545	184	617	0	2226	P	ORGANIC	CARBO	0	0	0		1991	S	
264	555	C	2		546	167	607	0	2230		CERAMICA	INFORME	0	0	0		1991	S	
264	555	C	2		547	308	473	0	2208	S	RMI	BNA	0	0	0	FRAG	1991	S	
264	555	C	2		548	44	404	1920	2140	V	RMI	BNA	0	0	0		1991	S	
264	555	C	2		549	290	503	0	2240	E	CALCARIA	BNA	0	0	0	FRAG	1991	S	
264	555	C	2		550	124	484	0	2207		ORGANIC	CARBO	0	0	0		1991	S	
264	555	C	2		551	438	846	0	2062	N	SORRENCA	BNA	0	0	0	FRAG	1991	S	
264	555	C	2		552	396	771	0	2067	E	ESQUIST	BNA	0	0	0	FRAG	1991	S	
264	555	C	2		553	357	814	0	2086	S	QUARS	BNA	0	0	0	FRAG	1991	S	
264	555	C	2		554	685	749	0	2057	S	SILEX	BPF	0	0	0		1991	F	
264	555	C	2		555	749	264	0	2055	W	QUARS	BPF	0	0	0		1991	S	
264	555	C	2		556	562	365	0	2086	P	CALCARIA	BP	0	0	0		1991	S	
264	555	C	2		557	190	536	0	2127	W	OS	DET	0	0	0		1991	S	
264	555	C	2		558	436	317	0	2125	NE	CERAMICA	INFORME	0	0	0		1991	S	
264	555	C	2		559	745	493	0	2090	W	CERAMICA	INFORME	0	0	0		1991	S	
264	555	C	2		560	771	524	0	2094	W	CERAMICA	INFORME	0	0	0		1991	S	
264	555	C	2		561	698	721	0	2148	NW	QUARS	BNA	0	0	0	FRAC	1991	S	
264	555	C	2		562	720	751	0	2142	V	CALCARIA	BNA	0	0	0		1991	S	
264	555	C	2		563	626	845	0	2133	V	CERAMICA	INFORME	0	0	0		1991	S	
264	555	C	2		564	714	837	0	2090	V	CERAMICA	APLICA	0	0	0	LLENGUETA	1991	S	

BOBILA MADURELL  
MAS DURAN  
Objectes Coordinats C5  
Campanya 1991

c	c	C	N													ALTERACIONS	P	D	
uX	uY	O	I	NUM.	X	Y	Zsup	Zinf	ORIENT	PENDENT	MATERIA	OBJECTE	LONG	AMPL	ESPE	OBSERVACIONS	ANY	U	I
a	a	N	V														N	B	
d	d	J															T	U	
264	555	C	2	565	758	413	0	2083	P		QUARSITA	BNA	0	0	0		1991	S	
264	555	C	2	566	730	373	0	2078	W		QUARS	BNA	0	0	0	FRAG	1991	S	
264	555	C	2	567	766	360	0	2063	W		CERAMICA	INFORME	0	0	0		1991	S	
264	555	C	2	568	669	594	0	2112	E		CONGLOME	BNA	0	0	0	FRAG	1991	S	
264	555	C	2	569	637	619	0	2131	E		CALCARIA	BNA	0	0	0	FRAG ALTERAT	1991	S	
264	555	C	2	570	692	698	0	2120	N		CONGLOME	BNA	0	0	0	FRAG MICROCONGL	1991	S	
264	555	C	2	571	824	654	0	2099	V		QUARS	BNA	0	0	0	FRAG	1991	S	
264	555	C	2	572	506	707	0	2146	W		CERAMICA	INFORME	0	0	0		1991	S	
264	555	C	2	573	452	477	2035	2173	W		SORRENCA	BNA	0	0	0	FRAG	1991	S	
264	555	C	2	574	678	360	0	2107	V		RMI	BNA	0	0	0	FRAG	1991	S	
264	555	C	2	575	600	729	0	2160	W		CERAMICA	INFORME	0	0	0	VARIS FRAGS	1991	S	
264	555	C	2	576	654	626	0	2139	V		QUARS	BNA	0	0	0	FRAG	1991	S	
264	555	C	2	577	722	723	0	2159			ORGANIC	CARBO	0	0	0		1991	S	
264	555	C	2	578	706	657	0	2112	W		CERAMICA	INFORME	0	0	0		1991	S	
264	555	C	2	579	840	299	0	2073	NW		CERAMICA	INFORME	0	0	0		1991	S	
264	555	C	2	580	890	351	0	2105	N		RMI	BNA	0	0	0	FRAG	1991	S	
264	555	C	2	581	895	411	0	2105	P		SORRENCA	BNA	0	0	0		1991	S	
264	555	C	2	582	760	492	0	2130	W		SILEX	BP	0	0	0		1991	S	
264	555	C	2	583	713	562	0	2134	P		CERAMICA	APLICA	0	0	0	MUGRO	1991	S	
264	555	C	2	584	898	690	0	2070	W		CERAMICA	INFORME	0	0	0		1991	S	
264	555	C	2	585	749	743	0	2157	V		CERAMICA	VORA	0	0	0		1991	S	
264	555	C	2	586	838	799	0	2090	V		RMI	BNA	0	0	0	FRAG	1991	S	
264	555	C	2	587	839	886	0	2064	W		CALCARIA	BPF	0	0	0		1991	S	
264	555	C	2	588	368	402	0	2203	W		CONGLOME	BNA	0	0	0	FRAG MICROCONGL	1991	S	
264	555	C	2	589	746	458	0	2212	P		CONGLOME	BNA	0	0	0	FRAG MICROCONGL	1991	S	
264	555	C	2	590	610	555	0	2170	P		QUARS	BN1G	0	0	0		1991	S	
264	555	C	2	592	522	746	0	2187	N		ESQUIST	BNA	0	0	0	FRAG	1991	S	
264	555	C	2	593	826	779	0	2147	V		OS	DET	0	0	0		1991	S	
264	555	C	2	594	659	559	0	2192	W		INDET	BNA	0	0	0	FRAG	1991	S	
264	555	C	2	595	659	665	0	2200	W		RMI	BNA	0	0	0	FRAC	1991	S	
264	555	C	2	596	574	676	0	2207	E		QUARS	BNA	0	0	0	FRAG	1991	S	
264	555	C	2	597	620	926	0	2171	S		OS	DET	0	0	0		1991	S	
264	555	C	2	598	485	501	0	2210	P		ESQUIST	BNA	0	0	0	FRAG	1991	S	
264	555	C	2	599	511	559	0	2206	N		QUARS	BNA	0	0	0	FRAG	1991	S	
264	555	C	2	600	545	578	0	2200	W		QUARS	BNA	0	0	0	FRAG	1991	S	
264	555	C	2	601	498	621	0	2220			OS	DET	0	0	0	FRAG MD	1991	S	
264	555	C	2	602	894	413	0	2130	W		CALCARIA	BPF	0	0	0		1991	S	
264	555	C	2	603	895	683	0	2141	NW		QUARS	BNA	0	0	0	FRAC	1991	S	
264	555	C	2	604	409	552	0	2236	N		CONGLOME	BNA	0	0	0		1991	S	
264	555	C	2	605	670	666	0	2192	N		QUARS	BNA	0	0	0	FRAC	1991	S	
264	555	C	2	606	487	783	0	2256	S		RMI	BNA	0	0	0	FRAG	1991	S	
264	555	C	2	607	425	736	0	2260	S		INDET	BNA	0	0	0	FRAC	1991	S	
264	555	C	2	608	475	211	0	2245	W		RMI	BNA	0	0	0	FRAG	1991	S	
264	555	C	3	609	357	974	0	2228	S		CONGLOME	BNA	0	0	0	FRAG MICROCONGL	1991	S	
264	555	C	3	610	150	953	0	2296	P		CALCARIA	BNA	0	0	0		1991	S	
264	555	C	3	611	235	920	0	2309	S		CALCARIA	BNA	0	0	0		1991	S	
264	555	C	3	612	229	970	0	2294	N		CONGLOME	BNA	0	0	0	MICROCONGLOME	1991	S	
264	555	C	3	613	515	906	0	2292	W		RMI	BNA	0	0	0	FRAG	1991	S	
75	264	555	C	3	614	120	969	0	2305	S	RMI	BPI	0	0	0		1991	S	
264	555	C	3	615	161	872	0	2304	P		QUARS	BNA	0	0	0	FRAG	1991	S	

BOBILA MADURELL  
MAG DURAN  
Objectes Coordinats C5  
Campanya 1991

c c C N												ALTERACIONS	P D					
uX	uY	O	I	NUM.	X	Y	Zsup	Zinf	ORIENT	PENDENT	MATERIA	OBJECTE	LONG	AMPL	ESPE	OBSERVACIONS	ANY	U I
a a N V																		N B
d	d	J															T U	
264	555	C	3		616	247	822	0	2311	P	CALCARIA	BP	0	0	0		1991	S
264	555	C	3		617	313	910	0	2309	P	INDET	BNA	0	0	0		1991	S
264	555	C	3		618	391	881	0	2312	E	QUARSITA	BNA	0	0	0		1991	S
264	555	C	3		619	458	855	0	2299	W	CALCARIA	BNA	0	0	0	FRAG	1991	S
264	555	C	3		620	187	926	0	2308		ORGANIC	CARBO	0	0	0		1991	S
264	555	C	3		621	485	94	0	2100	E	QUARS	BNA	0	0	0		1991	
264	555	C	3		622	947	93	0	2118	NE	QUARS	BNA	0	0	0	FRAG	1991	S
264	555	C	3		623	853	140	0	2101	P	CERAMICA	INFORME	0	0	0	TOVOT	1991	
264	555	C	3		624	841	81	0	2109	N	SORRENCA	BNA	0	0	0	FRAG ALTERAT	1991	S
264	555	C	3		625	558	177	0	2090	NW	CERAMICA	INFORME	0	0	0		1991	S
264	555	C	3		626	481	77	0	2116	S	CERAMICA	APLICA	0	0	0	FRAG	1991	S
264	555	C	3		627	536	81	0	2127	S	CALCARIA	BNA	0	0	0	FRAG ALTERAT	1991	S
264	555	C	3		628	505	260	0	2101	P	SILEX	BNA	0	0	0	FRAG ALTERAT	1991	S
264	555	C	3		629	850	149	0	2129	P	CERAMICA	VORA	0	0	0		1991	S
264	555	C	3		630	821	220	0	2134	S	CALCARIA	BNA	0	0	0	FRAG ALTERAT	1991	S
264	555	C	3		631	912	265	0	2130	S	CERAMICA	VORA	0	0	0		1991	S
264	555	C	3		632	879	656	0	2153	N	CERAMICA	INFORME	0	0	0		1991	S
264	555	C	3		633	554	317	0	2105	P	CALCARIA	BN2G	0	0	0	ALTERAT	1991	S
264	555	C	3		634	734	336	0	2133	N	RMI	BNA	0	0	0		1991	S
264	555	C	3		635	924	722	0	2111	V	RMI	BNA	0	0	0	FRAG	1991	S
264	555	C	3		636	682	406	0	2137	P	CERAMICA	INFORME	0	0	0	TOVOT	1991	S
264	555	C	3		637	827	325	0	2152	P	CALCARIA	BNA	0	0	0		1991	S
264	555	C	3		638	946	324	0	2121	P	RMI	BNA	0	0	0	FRAG	1991	S
264	555	C	3		639	799	144	0	2133	W	CALCARIA	BNA	0	0	0	ALTERAT	1991	S
264	555	C	3		640	608	13	0	2172	S	QUARS	BNA	0	0	0	FRAG	1991	S
264	555	C	3		641	617	70	0	2167	P	QUARS	BNA	0	0	0	FRAC	1991	S
264	555	C	3		642	691	58	0	2166	W	SORRENCA	BNA	0	0	0	FRAG	1991	S
264	555	C	3		643	748	58	0	2146	N	SORRENCA	BNA	0	0	0	FRAG	1991	S
264	555	C	3		644	815	105	0	2162	W	SORRENCA	BNA	0	0	0	FRAG	1991	S
264	555	C	3		645	922	197	0	2144	N	QUARSITA	BNA	0	0	0	FRAC	1991	S
264	555	C	3		646	558	152	0	2185	P	RMI	BNA	0	0	0	FRAG	1991	S
264	555	C	3		647	665	263	0	2173	V	SORRENCA	BNA	0	0	0	FRAG	1991	S
264	555	C	3		648	819	259	0	2168	P	RMI	BNA	0	0	0	FRAG	1991	S
264	555	C	3		649	895	300	0	2152	N	CERAMICA	INFORME	0	0	0		1991	S
264	555	C	3		650	988	277	0	2144	P	LIDITA	BNA	0	0	0	FRAC	1991	S
264	555	C	3		651	797	312	0	2166	S	CERAMICA	INFORME	0	0	0		1991	S
264	555	C	3		652	749	409	0	2157	N	SORRENCA	BNA	0	0	0		1991	S
264	555	C	3		653	909	417	0	2147	P	RMI	BNA	0	0	0	FRAG	1991	S
264	555	C	3		654	735	471	0	2210	P	ORGANIC	CARBO	0	0	0		1991	S
264	555	C	3		655	251	143	0	2174	NW	CERAMICA	INFORME	0	0	0	VARIS FRAGS	1991	S
264	555	C	3		656	554	48	0	2187	N	CONGLOME	BNA	0	0	0	MICROCONGLOME	1991	S
264	555	C	3		657	573	122	0	2186	N	RMI	BNA	0	0	0	FRAG	1991	S
264	555	C	3		658	538	170	0	2193	E	RMI	BNA	0	0	0	FRAG	1991	S
264	555	C	3		659	515	256	0	2210	W	CONGLOME	BNA	0	0	0	MICROCONGLOME	1991	S
264	555	C	3		660	637	276	0	2195	W	QUARS	BNA	0	0	0	FRAG	1991	S
264	555	C	3		661	752	552	0	2235	V	CALCARIA	BNA	0	0	0	ALTERAT	1991	S
264	555	C	3		662	815	632	0	2224	P	RMI	BNA	0	0	0	FRAG	1991	S
264	555	C	3		663	804	857	2140	2265	SW	CONGLOME	BNA	0	0	0	MICROCONGLOME	1991	S
264	555	C	3		664	362	37	0	2205	N	RMI	BNA	0	0	0	FRAG	1991	S
264	555	C	3		665	670	179	0	2200	NE	CERAMICA	VORA	0	0	0	3 FRAGS	1991	S

BOBILA MADURELL  
MAS DURAN  
Objectes Coordenats C5  
Campanya 1991

c	c	C	N	NUM.	X	Y	Zsup	Zinf	ORIENT	PENDENT	MATERIA	OBJECTE	LONG	AMPL	ESPE	ALTERACIONS	OBSERVACIONS	P	D	
uX	uY	O	I															ANY	U	I
a	a	N	V																N	B
d	d	J																	T	U
264	555	C	3	666	911	201		0	2220	N	QUARS	BNA	0	0	0	FRAG		1991	S	
264	555	C	3	667	463	131		0	2255	NW	QUARSITA	BNA	0	0	0			1991	S	
264	555	C	3	668	251	314		0	2247	S	QUARS	BNA	0	0	0	FRAC		1991	S	
264	555	C	3	669	837	205		0	2250	NE	CALCARIA	BNA	0	0	0	FRAG		1991	S	
264	555	C	3	670	838	296		0	2240	W	CERAMICA	INFORME	0	0	0			1991	S	
264	555	C	3	671	571	75	2175	2280		S	CALCARIA	BNA	0	0	0	FRAG		1991	S	
264	555	C	3	672	575	561	2210	2305		E	CALCARIA	BNA	0	0	0			1991	S	
264	555	C	3	673	653	620		0	2260	P	QUARS	BNA	0	0	0			1991	S	
264	555	C	3	674	767	646		0	2265	SW	CALCARIA	BNA	0	0	0	FRAG		1991	S	
264	555	C	3	675	837	593		0	2260	E	QUARS	BNA	0	0	0	FRAG		1991	S	
264	555	C	3	676	836	667		0	2260	P	CERAMICA	INFORME	0	0	0			1991	S	
264	555	C	3	677	776	711		0	2265	V	CERAMICA	INFORME	0	0	0			1991	S	
264	555	C	3	678	711	698		0	2255	S	CERAMICA	VORA	0	0	0			1991	S	
264	555	C	3	679	528	787		0	2290	W	CALCARIA	BNA	0	0	0			1991	S	
264	555	C	3	680	460	734		0	2290	P	CALCARIA	BNA	0	0	0	ALTERAT		1991	S	
264	555	C	3	681	642	115		0	2295	SE	CERAMICA	INFORME	0	0	0	TERRACOTA		1991	S	
264	555	C	3	682	595	166		0	2320	W	CERAMICA	APLICA	0	0	0	LLENGETA		1991	S	
264	555	C	3	683	710	352		0	2275	P	CERAMICA	INFORME	0	0	0	TERRACOTA		1991	S	
264	555	C	3	684	585	347		0	2305	S	CERAMICA	INFORME	0	0	0	2 FRAGS		1991	S	
264	555	C	3	685	549	366		0	2310	S	CERAMICA	INFORME	0	0	0			1991	S	
264	555	C	3	686	370	476		0	2315	P	SILEX	BP2G	0	0	0			1991	S	
264	555	C	3	687	133	756		0	2290	V	RMI	BNA	0	0	0	FRAG		1991	S	
264	555	C	3	688	453	702		0	2310	P	OS	INDET	0	0	0	2 FRAGS		1991	S	
264	555	C	3	689	483	703		0	2300	N	OS	DET	0	0	0	MD Inf		1991	S	
264	555	C	3	690	515	755		0	2330	V	CERAMICA	INFORME	0	0	0			1991	S	
264	555	C	3	691	606	88		0	2320	E	QUARS	BNA	0	0	0			1991	S	
264	555	C	3	692	680	162		0	2320	P	CALCARIA	BNA	0	0	0	FRAC		1991	S	
264	555	C	3	693	512	266		0	2350	V	QUARSITA	BNA	0	0	0			1991	S	
264	555	C	3	694	452	233		0	2355	SE	SORRENCA	BNA	0	0	0	FRAG ALTERAT		1991	S	
264	555	C	3	695	910	609		0	2290	S	QUARSITA	BNA	0	0	0	FRAG		1991	S	
264	555	C	3	696	747	631		0	2315	S	OS	DET	0	0	0	VT		1991	S	
264	555	C	3	697	385	931		0	2425	V	RMI	BNA	0	0	0	FRAG		1991	S	
264	555	C	3	698	374	675		0	2348	V	CALCARIA	BNA	0	0	0	FRAG ALTERAT		1991	S	
264	555	C	3	699	385	554		0	2340	W	CALCARIA	BNA	0	0	0	FRAG ALTERAT		1991	S	
264	555	C	3	700	472	466		0	2335	P	RMI	BNE	0	0	0	FRAG		1991	S	
264	555	C	3	701	421	415		0	2346	SW	CERAMICA	INFORME	0	0	0	TOVOT		1991	S	
264	555	C	3	702	300	618		0	2390	P	QUARSITA	BNA	0	0	0			1991	S	
264	555	C	3	703	225	606		0	2378	SW	RMI	BNA	0	0	0			1991	S	
264	555	C	3	704	147	577		0	2380	P	CONGLOME	BNA	0	0	0			1991	S	
264	555	C	3	705	457	144		0	2360	NW	CALCARIA	BNA	0	0	0	FRAG ALTERAT		1991	S	
264	555	C	3	706	401	164		0	2373	N	RMI	BNA	0	0	0	FRAG		1991	S	
264	555	C	3	707	307	31		0	2345	S	RMI	BNA	0	0	0	FRAG		1991	S	
264	555	C	3	708	775	390		0	2333	S	RMI	BNA	0	0	0	FRAG		1991	S	
264	555	C	3	709	885	720		0	2325	P	CERAMICA	INFORME	0	0	0	2 FRAGS		1991	S	
264	555	C	3	710	231	69		0	2380	V	RMI	BNA	0	0	0	FRAG		1991	S	
264	555	C	3	711	166	208		0	2416	V	CALCARIA	BN1G	0	0	0			1991	S	
264	555	C	3	712	177	347		0	2405	N	RMI	BNA	0	0	0	FRAG ALTERAT		1991	S	
264	555	C	3	713	174	651		0	2384	S	CERAMICA	INFORME	0	0	0			1991	S	
264	555	C	3	714	306	481		0	2405	W	CERAMICA	INFORME	0	0	0			1991	S	
264	555	C	3	715	226	469		0	2415	E	CALCARIA	BNA	0	0	0	FRAC		1991	S	



BOBILA MADURELL  
MAS DURAN  
Objectes Coordenats C5  
Campanya 1991

c	c	C	N										ALTERACIONS			P	D				
uX	uY	O	I	NUM.	X	Y	Zsup	Zinf	ORIENT	PENDENT	MATERIA	OBJECTE	LONG	AMPL	ESPE	OBSERVACIONS	ANY	U	I		
a	a	N	V																N	B	
d	d	J																	T	U	
264	555	C	3	716	301	340	0	2430	S	OS	DET	0	0	0	EI MPa		1991	S			
264	555	C	3	717	211	310	0	2440	W	SORRENCA	BNA	0	0	0	FRAG		1991	S			
264	555	C	3	718	140	270	0	2430	E	RMI	BNA	0	0	0	FRAG		1991	S			
264	555	C	3	719	97	170	0	2405	E	CALCARIA	BNA	0	0	0	FRAC		1991	S			
264	555	C	3	720	164	65	0	2370	NE	RMI	BNA	0	0	0	FRAG		1991	S			
264	555	C	3	721	11	646	2226	2351	SW	CONGLOME	BNA	0	0	0	MICROCONG	ALTER	1991	S			
264	555	C	3	722	26	395	0	2441	SW	RMI	BNA	0	0	0	FRAG		1991	S			
264	555	C	3	723	12	267	0	2422	NE	RMI	BNE	0	0	0	FRAG MOLI		1991	S			
264	555	C	3	724	71	77	0	2433	V	CALCARIA	BNA	0	0	0	FRAG		1991	S			
264	555	C	3	725	162	134	0	2444	NW	RMI	BNE	0	0	0	FRAG MOLI		1991	S			
264	555	C	3	726	23	158	0	2410		OS	DET	0	0	0	MICRO		1991	S			
264	555	C	3	727	178	208	0	2430	S	CERAMICA	INFORME	0	0	0			1991	S			
264	555	C	3	728	161	401	0	2465	S	OS	DET	0	0	0			1991	S			
264	555	C	3	729	115	225	0	2463	SE	CALCARIA	BNA	0	0	0			1991	S			
264	555	C	3	730	191	210	0	2462	SE	RMI	BNA	0	0	0	FRAG		1991	S			
264	555	C	3	731	277	268	0	2468	V	RMI	BNA	0	0	0	FRAG		1991	S			
264	555	C	3	732	372	814	0	2510	S	OS	DET	0	0	0			1991	S			
264	555	C	3	733	152	212	0	2483	V	RMI	BNA	0	0	0	FRAG		1991	S			
264	555	C	3	734	235	186	0	2505	NW	CERAMICA	INFORME	0	0	0			1991	S			
264	556	C		1	581	103	0	1320	E	CALCARIA	FRAG	0	0	0			1991	S			
264	556	C		2	657	217	1300	1339	N	QUARSITA	BNA	0	0	0			1991	S			
264	556	C		3	797	340	1285	1309	E	CALCARIA	CODOLF	0	0	0			1991	S			
264	556	C		4	432	244	1273	1301	SE	QUARS	BNA	0	0	0	FRAG		1991	S			
264	556	C		5	330	304	1290	1328	S	SORRENCA	BNA	0	0	0	FRAG		1991	S			
264	556	C		6	393	455	1231	1264	NW	SORRENCA	BNA	0	0	0	FRAG		1991	S			
264	556	C		7	864	876	1244	1326	SW	RMI	BNA	0	0	0			1991	S			
264	556	C		8	440	875	1239	1278	W	QUARSITA	BNA	0	0	0	FRAG		1991	S			
264	556	C		9	505	909	1234	1272	NW	QUARS	BNA	0	0	0	FRAG		1991	S			
264	556	C		10	806	903	1186	1273	NW	CONGLOME	BNA	0	0	0	MICROCONGL	FRAG	1991	S			
264	556	C		11	696	890	1254	1286	SE	SORRENCA	BNA	0	0	0	FRAG		1991	S			
264	556	C		12	939	731	1187	1233	SE	SORRENCA	BNA	0	0	0	FRAG		1991	S			
264	556	C		13	463	771	1196	1230	W	RMI	BNA	0	0	0	FRAG		1991	S			
264	556	C		14	471	775	0	1278	S	CERAMICA	INFORME	0	0	0			1991	S			
264	556	C		15	436	951	1216	1249	S	CALCARIA	BNA	0	0	0	FRAG		1991	S			
264	556	C		16	696	875	1217	1258	E	GRANIT	FRAG	0	0	0			1991	S			
264	556	C		17	938	876	1274	1294	N	QUARS	FRAG	0	0	0			1991	S			
264	556	C		18	459	702	0	1285	W	SORRENCA	FRAG	0	0	0			1991	S			
264	556	C		19	505	736	0	1270	N-S	W	INDET	FRAG	0	0	0			1991	S		
264	556	C		20	345	714	0	1275	NW-SE	W	INDET	FRAG	0	0	0			1991	S		
264	556	C		21	499	532	0	1258	N-S	N	CERAMICA	INFORME	0	0	0			1991	S		
264	556	C		22	942	480	0	1285		V	CERAMICA	INFORME	0	0	0			1991	S		
264	556	C		23	427	278	0	1287	NW-SE	W	CERAMICA	INFORME	0	0	0			1991	S		
264	556	C		24	124	732	0	1315		SE	INDET	BNA	0	0	0			1991	S		
264	556	C		25	427	278	0	1365			QUARS	BNA	0	0	0	FRAG		1991	S		
264	556	C		27	65	540	0	1339			CALCARIA	BPF	0	0	0			1991	S		
264	556	C		28	251	906	0	1394	P		CALCARIA	BNA	0	0	0	FRAG		1991	S		
264	556	C		29	28	782	0	1375	P		SILEX	BPI	0	0	0			1991	S		
264	556	C		30	451	385	0	1415	P		INDET	BNA	0	0	0			1991	S		
264	556	C		31	154	624	0	1430	N		QUARSITA	BNA	0	0	0			1991	S		
264	556	C		33	936	619	0	1435	W		CERAMICA	VORA	0	0	0			1991	S		

BOBILA MADURELL  
MAS DURAN  
Objectes Coordinats C5  
Campanya 1991

c c C N																	ALTERACIONS				P D	
uX	uY	O I	NUM.	X	Y	Zsup	Zinf	ORIENT	PENDENT	MATERIA	OBJECTE	LONG	AMPL	ESPE	OBSERVACIONS	ANY	U I	N B	T U			
a	a	N V																				
d	d	J																				
264	556	C	34	974	755	0	1440			CERAMICA	INFORME	0	0	0	NO RECUPERAT	1991	S					
264	556	C	35	19	320	0	1390	P		CERAMICA	INFORME	0	0	0		1991	S					
264	556	C 2	36	466	510	0	1469	NW		RMI	BNA	0	0	0		1991	S					
264	556	C 2	37	276	146	0	1485	P		CERAMICA	INFORME	0	0	0		1991	S					
264	556	C 2	38	245	149	0	1485	P		CALCARIA	BNA	0	0	0		1991	S					
264	556	C 2	39	299	257	0	1502	P		QUARS	BNA	0	0	0	FRAG	1991	S					
264	556	C 2	40	416	252	0	1510	N		QUARS	BNA	0	0	0	FRAG	1991	S					
264	556	C 2	41	56	368	0	1475	P		RMI	BNA	0	0	0		1991	S					
264	556	C 2	42	33	377	0	1480	E		CONGLOME	BNA	0	0	0	FRAG MICROCONGL	1991	S					
264	556	C 2	43	884	718	0	1475			CERAMICA	INFORME	0	0	0		1991	S					
264	556	C 2	44	466	600	0	1482	S		CERAMICA	INFORME	0	0	0		1991	S					
264	556	C 2	45	42	39	0	1475	P		RMI	BNA	0	0	0	FRAG	1991	S					
264	556	C 2	46	214	23	0	1468	P		QUARS	BNA	0	0	0	NO RECUPERAT	1991	S					
264	556	C 2	47	121	330	0	1501	SE		QUARS	BNA	0	0	0	FRAC	1991	S					
264	556	C 2	49	368	562	0	1510	P		QUARS	BNA	0	0	0		1991	S					
264	556	C 2	50	56	811	0	1518	V		SORRENCA	BNA	0	0	0		1991	S					
264	556	C 2	51	785	79	0	1521			OS	DET	0	0	0		1991	S					
264	556	C 2	52	756	986	0	1543	V		RMI	BNA	0	0	0	FRAG	1991	S					
264	556	C 2	53	822	62	0	1553	W		SORRENCA	BNA	0	0	0	FRAG	1991	S					
264	556	C 2	54	973	508	1487	1540	P		RMI	BNE	0	0	0	BNE?	1991	S					
264	556	C 2	55	983	701	0	1531	P		RMI	BNA	0	0	0	FRAG	1991	S					
264	556	C 2	56	145	293	0	1509	P		CERAMICA	INFORME	0	0	0	2 FRAGS	1991	S					
264	556	C 2	57	149	270	0	1509	P		CERAMICA	INFORME	0	0	0		1991	S					
264	556	C 2	58	89	249	0	1515	P		RMI	BNA	0	0	0	FRAG	1991	S					
264	556	C 2	59	207	219	0	1512	NE		QUARSITA	BNA	0	0	0	FRAG	1991	S					
264	556	C 2	60	836	125	0	1595	P		SORRENCA	BNA	0	0	0	FRAG	1991	S					
264	556	C 2	61	153	226	0	1535	P		SORRENCA	BNA	0	0	0	FRAG	1991	S					
264	556	C 2	62	836	125	0	1530	P		CALCARIA	BP	0	0	0		1991	S					
264	556	C 2	63	15	384	0	1513	W		CERAMICA	INFORME	0	0	0		1991	S					
264	556	C 2	64	125	162	0	1533	NW		SORRENCA	BNA	0	0	0	FRAG	1991	S					
264	556	C 2	65	928	270	0	1618	P		QUARS	BP	0	0	0		1991	S					
264	556	C 2	66	792	246	0	1628	P		SORRENCA	BPF	0	0	0		1991	S					
264	556	C 2	67	903	337	0	1600	W		CERAMICA	INFORME	0	0	0		1991	S					
264	556	C 2	68	725	331	0	1610	N		RMI	BNA	0	0	0	FRAG	1991	S					
264	556	C 2	69	840	406	0	1611	V		QUARS	BNA	0	0	0	FRAG	1991	S					
264	556	C 2	70	593	934	0	1583	W		SORRENCA	BNA	0	0	0	FRAG	1991	S					
264	556	C 2	71	495	15	0	1572	SE		CERAMICA	INFORME	0	0	0		1991	S					
264	556	C 2	72	553	253	0	1589	S		CERAMICA	INFORME	0	0	0		1991	S					
264	556	C 2	73	984	665	0	1615	P		CERAMICA	INFORME	0	0	0		1991	S					
264	556	C 2	74	90	602	0	1555	P		RMI	BNA	0	0	0	FRAG	1991	S					
264	556	C 2	75	524	495	0	1615	P		QUARS	BNA	0	0	0	FRAG	1991	S					
264	556	C 2	76	531	320	0	1626	P		INDET	BNA	0	0	0		1991	S					
264	556	C 2	77	620	430	0	1599	W		RMI	BNA	0	0	0	FRAG	1991	S					
264	556	C 2	78	248	29	0	1603	SW		QUARS	BNA	0	0	0	FRAG	1991	S					
264	556	C 2	79	119	319	0	1612	P		CALCARIA	BNA	0	0	0		1991	S					
264	556	C 2	80	248	29	0	1589	P		QUARS	BNA	0	0	0	FRAG	1991	S					
264	556	C 2	81	119	319	0	1626	W		QUARS	BNA	0	0	0	FRAG	1991	S					
264	556	C 2	82	28	455	0	1630	P		SORRENCA	BNA	0	0	0	FRAG NO RECUPER	1991	S					
264	556	C 2	83	530	576	0	1592	S		CONGLOME	BNA	0	0	0	FRAG MICROCONGL	1991	S					
264	556	C 2	84	713	364	0	1616	E		SILEX	BPI	0	0	0		1991	S					

BOBILA MADURELL  
 MAS DURAN  
 Objectes Coordinats C5  
 Campanya 1991

c	c	C	N	NUM.	X	Y	Zsup	Zinf	ORIENT	PENDENT	MATERIA	OBJECTE	LONG	AMPL	ESPE	ALTERACIONS	OBSERVACIONS	P	D
uX	uY	O	I															ANY	U
a	a	N	V																I
d	d	J																	N
																			B
																			T
																			U
264	556	C	2	85	721	914	0	1642	S		RMI	BNA	0	0	0	FRAG		1991	S
264	556	C	2	86	36	25	0	1640	W		CONGLOME	BNA	0	0	0	MICROCONGLOME		1991	S
264	556	C	2	87	582	280	0	1618	P		QUARS	BNA	0	0	0			1991	S
264	556	C	2	88	870	472	0	1611	N		SILEX	BN2G	0	0	0			1991	S
264	556	C	2	89	640	910	0	1624	SW		CALCARIA	BP	0	0	0			1991	S
264	556	C	2	90	448	986	0	1636			CERAMICA	VORA	0	0	0			1991	S
264	556	C	2	91	400	712	0	1629	P		SILEX	BPI	0	0	0			1991	S
264	556	C	2	92	335	526	0	1631	P		CALCARIA	BP	0	0	0			1991	S
264	556	C	2	93	305	776	0	1624			ORGANIC	CARBO	0	0	0			1991	S
264	556	C	2	94	139	673	0	1632			CALCARIA	BP	0	0	0			1991	S
264	556	C	2	95	240	905	0	1626	SW		CERAMICA	INFORME	0	0	0			1991	S
264	556	C	2	96	136	454	0	1624	P		SILEX	BPF	0	0	0			1991	S
264	556	C	2	97	511	913	0	1633	P		QUARS	BNA	0	0	0			1991	S
264	556	C	2	98	374	737	0	1642	N		QUARS	BNA	0	0	0	FRAC		1991	S
264	556	C	2	99	439	780	0	1632	S		RMI	BNA	0	0	0	FRAG		1991	S
264	556	C	2	100	59	776	0	1663	E		CALCARIA	BPI	0	0	0			1991	S
264	556	C	2	101	690	633	0	1641	S		SILEX	BPI	0	0	0	2 FRAGS		1991	S
264	556	C	2	102	813	555	0	1646	S		CERAMICA	VORA	0	0	0			1991	S
264	556	C	2	103	744	502	0	1651	N		CERAMICA	APLICA	0	0	0	LLENGUETA		1991	
264	556	C	2	104	696	528	0	1653	E		RMI	BNA	0	0	0	FRAG		1991	S
264	556	C	2	105	413	542	0	1667	P		CERAMICA	APLICA	0	0	0	MUGRO		1991	S
264	556	C	2	106	490	460	0	1650	V		RMI	BNA	0	0	0	FRAC		1991	S
264	556	C	2	107	400	484	0	1655	NW		QUARS	BP2G	0	0	0			1991	S
264	556	C	2	108	611	364	0	1654	N		CALCARIA	BPI	0	0	0	ALTERAT		1991	S
264	556	C	2	109	66	443	0	1648	SW		CONGLOME	BNA	0	0	0	FRAG MICROCONGL		1991	S
264	556	C	2	110	911	770	0	1640	P		CALCARIA	BP	0	0	0			1991	S
264	556	C	2	111	144	713	0	1654	P		QUARS	BNA	0	0	0	FRAG		1991	S
264	556	C	2	112	244	665	0	1653	S		QUARSITA	BNA	0	0	0	FRAG		1991	S
264	556	C	2	114	415	622	0	1637	W		CALCARIA	BP	0	0	0	ALTERAT		1991	S
264	556	C	2	115	443	579	0	1670	S		CERAMICA	INFORME	0	0	0			1991	S
264	556	C	2	116	748	30	0	1666	V		QUARSITA	BNE	0	0	0	FRAG DESTRAL		1991	S
264	556	C	2	117	780	335	0	1647	P		CERAMICA	INFORME	0	0	0	ARGILA CUITA		1991	S
264	556	C	2	118	692	271	0	1656	V		RMI	BNA	0	0	0			1991	S
264	556	C	2	119	382	328	0	1647	S		CONGLOME	BNA	0	0	0	FRAG		1991	S
264	556	C	2	120	444	167	0	1639	S		SORRENCA	BNA	0	0	0	ALTERAT		1991	S
264	556	C	2	121	251	48	0	1648	SE		SORRENCA	BNA	0	0	0	FRAG		1991	S
264	556	C	2	122	384	108	0	1652			OS	INDET	0	0	0			1991	S
264	556	C	2	123	254	116	0	1634	V		CALCARIA	BPF	0	0	0			1991	S
264	556	C	2	124	124	237	1561	1655	V		CALCARIA	BNA	0	0	0			1991	S
264	556	C	2	125	375	38	0	1660	S		RMI	BNA	0	0	0	FRAG		1991	S
264	556	C	2	126	302	21	0	1671	V		QUARS	BNA	0	0	0			1991	S
264	556	C	2	127	410	40	0	1666	SE		CERAMICA	INFORME	0	0	0			1991	S
264	556	C	2	128	984	13	0	1668	P		CALCARIA	BPF	0	0	0			1991	S
264	556	C	2	129	930	169	0	1657	V		QUARS	BNA	0	0	0			1991	S
264	556	C	2	130	966	177	0	1667	V		QUARS	BNA	0	0	0			1991	S
264	556	C	2	131	905	301	0	1680	P		CERAMICA	INFORME	0	0	0			1991	S
264	556	C	2	132	763	346	0	0	P		GRANIT	BNA	0	0	0	FRAG NO RECUPER		1991	
264	556	C	2	133	703	356	0	1674	E		CONGLOME	BNA	0	0	0	FRAG MICROCONGL		1991	S
264	556	C	2	134	681	337	0	0	V		CALCARIA	BNA	0	0	0	FRAG NO RECUPER		1991	S
264	556	C	2	135	642	339	0	1670	V		QUARS	BPI	0	0	0			1991	S

BOBILA MADURELL  
MAS DURAN  
Objectes Coordinats C5  
Campanya 1991

c	c	C	N												ALTERACIONS			P	D		
uX	uY	O	I	NUM.	X	Y	Zsup	Zinf	ORIENT	PENDENT	MATERIA	OBJECTE	LONG	AMPL	ESPE	OBSERVACIONS	ANY	U	I		
a	a	N	V																	N	B
d	d	J																		T	U
264	556	C	2	136	410	358	0	1661	S		CERAMICA	INFORME	0	0	0		1991	S			
264	556	C	2	137	259	304	0	1665	P		QUARS	BNA	0	0	0		1991	S			
264	556	C	2	138	164	293	0	1670	V		SORRENCA	BNA	0	0	0	FRAG	1991	S			
264	556	C	2	139	106	281	0	1667	V		SORRENCA	BNA	0	0	0		1991	S			
264	556	C	2	140	334	551	0	1676	V		SORRENCA	BNA	0	0	0	FRAG	1991	S			
264	556	C	2	141	45	597	0	1665	E		CONGLOME	BNA	0	0	0	FRAG MICROCONGL	1991	S			
264	556	C	2	142	191	655	0	1669	P		CERAMICA	INFORME	0	0	0		1991	S			
264	556	C	2	143	250	662	0	1671	P		CERAMICA	INFORME	0	0	0		1991	S			
264	556	C	2	144	414	688	0	1678	V		QUARSITA	BNA	0	0	0	FRAG	1991	S			
264	556	C	2	145	180	724	0	1667	P		CERAMICA	INFORME	0	0	0		1991	S			
264	556	C	2	147	24	779	0	1666	E		CERAMICA	INFORME	0	0	0		1991	S			
264	556	C	2	148	43	835	0	1664	V		QUARS	BNA	0	0	0	FRAG	1991	S			
264	556	C	2	149	109	619	0	1677	V		CERAMICA	INFORME	0	0	0		1991	S			
264	556	C	2	150	409	445	0	1671	P		RMI	BNA	0	0	0	FRAG	1991	S			
264	556	C	2	151	758	175	0	1679	W		CALCARIA	BPI	0	0	0		1991	S			
264	556	C	2	152	599	250	0	1684	S		CONGLOME	FRAG	0	0	0	NO RECUPERAT	1991	S			
264	556	C	2	153	360	387	0	1671	N		CALCARIA	BPI	0	0	0		1991	S			
264	556	C	2	154	467	475	0	1682	N		CERAMICA	INFORME	0	0	0		1991	S			
264	556	C	2	155	802	281	0	1687	P		SORRENCA	BNA	0	0	0	FRAG	1991	S			
264	556	C	2	156	410	143	0	1679	P		QUARS	BPF	0	0	0		1991	S			
264	556	C	2	157	142	936	0	1684	P		CERAMICA	INFORME	0	0	0		1991	S			
264	556	C	2	158	215	674	0	1694	P		QUARS	FRAG	0	0	0		1991	S			
264	556	C	2	160	337	260	0	1694	SW		SORRENCA	BNA	0	0	0	ALTERAT	1991	S			
264	556	C	2	161	380	293	0	1705	P		QUARSITA	BNA	0	0	0		1991	S			
264	556	C	2	162	507	201	0	1693	P		QUARS	BNA	0	0	0	FRAG	1991	S			
264	556	C	2	163	672	369	0	1695	N		SORRENCA	BNA	0	0	0	FRAG	1991	S			
264	556	C	2	164	908	12	0	1684	E		SORRENCA	BNA	0	0	0	FRAG NO RECUPER	1991	S			
264	556	C	2	165	145	9	0	1679	S		SORRENCA	BNA	0	0	0	FRAG	1991	S			
264	556	C	2	166	263	359	0	1701	V		CALCARIA	BNA	0	0	0		1991	S			
264	556	C	2	167	291	198	0	1705	P		SORRENCA	BNA	0	0	0	FRAG	1991	S			
264	556	C	2	168	358	226	0	1714	P		CALCARIA	BPF	0	0	0		1991	S			
264	556	C	2	169	443	992	0	1715	P		QUARS	BNA	0	0	0	FRAG	1991	S			
264	556	C	2	170	346	350	0	1711	P		QUARS	BPI	0	0	0		1991	S			
264	556	C	2	171	41	412	0	1705	V		OS	DET	0	0	0	DENT BOTA	1991	S			
264	556	C	2	172	81	511	0	1694	NW		INDET	FRAG	0	0	0		1991	S			
264	556	C	2	173	225	532	0	1711	S		CERAMICA	INFORME	0	0	0		1991	S			
264	556	C	2	174	288	514	0	1689	P		SORRENCA	BNA	0	0	0	FRAG	1991	S			
264	556	C	2	175	195	256	0	1710	P		CERAMICA	INFORME	0	0	0	2 FRAGS	1991	S			
264	556	C	2	176	123	218	0	1715	SW		CONGLOME	BNA	0	0	0	MICROCONGL FRAG	1991	S			
264	556	C	2	177	165	37	0	1691	P		CONGLOME	BNA	0	0	0	FRAG	1991	S			
264	556	C	2	178	300	154	0	1701	SW		SORRENCA	BNA	0	0	0	FRAG	1991	S			
264	556	C	2	179	366	157	0	1702	SW		CALCARIA	BPI	0	0	0		1991	S			
264	556	C	2	180	450	50	0	1692	V		QUARS	BPI	0	0	0		1991	S			
264	556	C	2	181	501	251	0	1705	P		SORRENCA	BNA	0	0	0	FRAG	1991	S			
264	556	C	2	182	513	209	0	1691	P		CERAMICA	INFORME	0	0	0		1991	S			
264	556	C	2	183	580	244	0	1695	NE		SORRENCA	BNA	0	0	0	FRAG	1991	S			
264	556	C	2	184	644	220	0	1693	NE		QUARS	BNA	0	0	0	FRAC	1991	S			
264	556	C	2	185	655	146	0	1702	V		SORRENCA	BNA	0	0	0	FRAG	1991	S			
264	556	C	2	186	659	308	0	1709	P		CALCARIA	BP	0	0	0		1991	S			
264	556	C	2	187	696	369	0	1711	N		QUARS	BNA	0	0	0	FRAG	1991	S			

BOBILA MADURELL  
MAS DURAN  
Objectes Coordenats C5  
Campanya 1991

c	c	C	N	NUM.	X	Y	Zsup	Zinf	ORIENT	PENDENT	MATERIA	OBJECTE	LONG	AMPL	ESPE	ALTERACIONS	OBSERVACIONS	P	D
uX	uY	O	I															ANY	U
a	a	N	V																I
d	d	J																	N
																			B
																			T
																			U
264	556	C	2	188	802	347	0	1694	P		SORRENCA	FRAG	0	0	0			1991	S
264	556	C	2	189	819	81	0	1694	N		QUARS	BPI	0	0	0			1991	S
264	556	C	2	190	802	124	0	1695	V		SILEX	BNA	0	0	0			1991	S
264	556	C	2	191	977	498	0	1705	V		CALCARIA	BN1G	0	0	0			1991	S
264	556	C	2	192	952	8	0	1701	SW		SORRENCA	BNA	0	0	0	FRAG		1991	S
264	556	C	2	193	984	594	0	1697	P		SORRENCA	BNA	0	0	0	FRAG		1991	S
264	556	C	2	194	286	650	0	1731	P		SORRENCA	BNA	0	0	0	FRAG		1991	S
264	556	C	2	195	923	75	0	1698	V		CALCARIA	BNA	0	0	0	FRAG		1991	S
264	556	C	2	196	497	516	0	1715	S		SORRENCA	BNA	0	0	0	FRAG		1991	S
264	556	C	2	197	70	480	0	1702	NE		CALCARIA	BNA	0	0	0			1991	S
264	556	C	2	198	43	42	0	1710	NW		SORRENCA	BNA	0	0	0	FRAG		1991	S
264	556	C	2	199	190	415	0	1730	SE		CALCARIA	BPF	0	0	0			1991	S
264	556	C	2	200	212	25	0	1711	S		SORRENCA	BPF	0	0	0			1991	S
264	556	C	2	201	240	108	0	1717	P		CALCARIA	FRAG	0	0	0	ALTERAT		1991	
264	556	C	2	202	301	20	0	1708	S		CONGLOME	BNA	0	0	0	FRAG		1991	S
264	556	C	2	203	307	48	0	1715	V		CERAMICA	VORA	0	0	0			1991	S
264	556	C	2	204	408	13	0	1715	V		RMI	BNA	0	0	0	FRAG		1991	S
264	556	C	2	205	371	155	0	1721	V		CONGLOME	BNA	0	0	0	MICROCONGL	FRAG	1991	S
264	556	C	2	206	437	275	0	1720	SE		CALCARIA	BPF	0	0	0			1991	S
264	556	C	2	207	504	28	0	1710	P		SORRENCA	BNA	0	0	0	FRAG		1991	S
264	556	C	2	208	502	136	0	1724	V		SORRENCA	BNA	0	0	0	FRAG		1991	S
264	556	C	2	209	526	168	0	1725	V		SORRENCA	BNA	0	0	0	FRAG		1991	S
264	556	C	2	210	563	35	0	1718	V		QUARS	BNA	0	0	0			1991	
264	556	C	2	211	610	39	0	1700	S		SORRENCA	BNA	0	0	0	FRAG		1991	S
264	556	C	2	213	618	99	0	1713	P		ESQUIST	BNA	0	0	0	FRAG		1991	S
264	556	C	2	214	645	206	0	1717	V		QUARS	BN1G	0	0	0			1991	S
264	556	C	2	215	641	266	0	1718	NW		QUARS	BNA	0	0	0	FRAG		1991	S
264	556	C	2	216	674	206	0	1723	V		ESQUIST	BNA	0	0	0	FRAG		1991	S
264	556	C	2	217	821	38	0	1718	P		RMI	BNA	0	0	0	FRAG		1991	S
264	556	C	2	218	883	602	0	1719	SW		SORRENCA	BNA	0	0	0	FRAG		1991	S
264	556	C	2	219	874	679	0	1718	SW		QUARS	BNA	0	0	0			1991	S
264	556	C	2	220	973	224	0	1719	S		QUARS	BPF	0	0	0			1991	S
264	556	C	2	221	132	777	0	1743	NE		SORRENCA	BNA	0	0	0	FRAG		1991	S
264	556	C	2	222	303	427	0	1734	NE		CERAMICA	INFORME	0	0	0			1991	S
264	556	C	2	223	308	384	0	1740	V		SORRENCA	BNA	0	0	0	FRAG		1991	S
264	556	C	2	224	320	350	0	1741	V		CERAMICA	INFORME	0	0	0			1991	S
264	556	C	2	225	344	271	0	1739	E		QUARS	BPF	0	0	0			1991	S
264	556	C	2	226	239	133	0	1734	E		CERAMICA	INFORME	0	0	0	TRENCAT		1991	S
264	556	C	2	227	274	872	0	1726	P		CERAMICA	INFORME	0	0	0	TRENCAT		1991	S
264	556	C	2	228	475	238	0	1737	P		CERAMICA	INFORME	0	0	0	TERRA CUITA		1991	S
264	556	C	2	229	445	174	0	1728	NW		QUARS	BPI	0	0	0			1991	S
264	556	C	2	230	433	98	0	1732	V		SILEX	BPF	0	0	0			1991	S
264	556	C	2	231	479	66	0	1736	V		SORRENCA	BNA	0	0	0	FRAG BNE?		1991	S
264	556	C	2	232	590	120	0	1736	P		CERAMICA	INFORME	0	0	0	TERRA CUITA		1991	S
264	556	C	2	233	973	636	0	1725	P		CERAMICA	INFORME	0	0	0			1991	S
264	556	C	2	234	81	81	0	1743	N		QUARS	BNA	0	0	0	FRAC		1991	S
264	556	C	2	235	44	184	0	1730	NE		SORRENCA	BNA	0	0	0	FRAG		1991	S
264	556	C	2	236	56	331	0	1758	NW		QUARS	FRAG	0	0	0			1991	S
264	556	C	2	237	59	455	0	1754	P		QUARS	BPF	0	0	0			1991	S
264	556	C	2	238	167	358	0	1750	V		QUARSITA	FRAG	0	0	0			1991	S

BOBILA MADURELL  
MAS DURAN  
Objectes Coordenats C5  
Campanya 1991

c	c	C	N											ALTERACIONS			P	D	
uX	uY	O	I	NUM.	X	Y	Zsup	Zinf	ORIENT	PENDENT	MATERIA	OBJECTE	LONG	AMPL	ESPE	OBSERVACIONS	ANY	U	I
a	a	N	V														N	B	
d	d	J															T	U	
264	556	C	2	239	164	25	0	1747	NE		CALCARIA BNA		0	0	0	FRAG	1991	S	
264	556	C	2	240	213	4	0	1741	P		CERAMICA INFORME		0	0	0		1991	S	
264	556	C	2	241	231	25	0	1754	P		SORRENCA BNA		0	0	0		1991	S	
264	556	C	2	242	287	6	0	1750	NE		SORRENCA BNA		0	0	0	FRAG	1991	S	
264	556	C	2	243	293	32	0	1748	V		QUARS BPI		0	0	0		1991	S	
264	556	C	2	244	889	323	0	1751	P		SORRENCA BP		0	0	0		1991	S	
264	556	C	2	245	550	45	0	1758	P		CONGLOME FRAG		0	0	0		1991		
264	556	C	2	246	527	209	0	1761	SE		QUARS BPI		0	0	0		1991	S	
264	556	C	2	247	32	327	0	1757	NW		CERAMICA INFORME		0	0	0		1991	S	
264	556	C	2	248	88	291	0	1759	N		CALCARIA BPF		0	0	0		1991	S	
264	556	C	2	249	75	215	0	1767	P		RMI BNA		0	0	0	FRAG	1991	S	
264	556	C	2	250	256	765	0	1759	P		SORRENCA BNA		0	0	0	FRAG	1991	S	
264	556	C	2	251	120	201	0	1771	SE		QUARSITA BPI		0	0	0		1991	S	
264	556	C	2	252	163	203	0	1766	SE		RMI BNA		0	0	0	FRAG	1991	S	
264	556	C	2	253	199	170	0	1772	NE		CALCARIA BPI		0	0	0		1991	S	
264	556	C	2	254	177	109	0	1755	V		RMI BNA		0	0	0	FRAG	1991	S	
264	556	C	2	255	162	85	0	1763	N		QUARS BNA		0	0	0	FRAG	1991	S	
264	556	C	2	256	404	211	0	1767	P		CONGLOME BNA		0	0	0	MICROCONGLOME	1991	S	
264	556	C	2	257	488	399	0	1782	NE		RMI BNA		0	0	0	FRAG	1991	S	
264	556	C	2	258	513	12	0	1757	SE		QUARS BNA		0	0	0		1991	S	
264	556	C	2	259	804	506	0	1761	NE		SILEX BN1G		0	0	0		1991	S	
264	556	C	2	260	840	365	0	1766	P		RMI BNA		0	0	0	FRAG	1991	S	
264	556	C	2	261	841	251	0	1757	P		CALCARIA BNA		0	0	0		1991	S	
264	556	C	2	262	38	20	0	1752	N		CALCARIA BPI		0	0	0		1991	S	
264	556	C	2	263	103	16	0	1763	S		QUARS BPI		0	0	0		1991	S	
264	556	C	2	264	239	73	0	1765	S		SILEX BN2G		0	0	0		1991	S	
264	556	C	2	265	277	45	0	1759	V		QUARS BPI		0	0	0		1991	S	
264	556	C	2	266	82	277	0	1778	S		QUARS BNA		0	0	0	FRAC	1991	S	
264	556	C	2	267	27	297	0	1780	P		QUARS CODOLF		0	0	0		1991	S	
264	556	C	2	268	219	406	0	1788	SE		SORRENCA BNA		0	0	0	FRAG	1991	S	
264	556	C	2	269	27	136	0	1793	P		CALCARIA BNA		0	0	0	FRAG NO RECUPER	1991	S	
264	556	C	2	270	138	129	0	1790	W		CERAMICA INFORME		0	0	0		1991	S	
264	556	C	2	271	163	73	0	1807	W		RMI BNA		0	0	0	FRAG	1991	S	
264	556	C	2	272	269	123	0	1795	W		CALCARIA BNA		0	0	0	FRAG NO RECUPER	1991	S	
264	556	C	2	273	85	36	0	1785	V		QUARS BNA		0	0	0	3 FRAGS	1991	S	
264	556	C	2	274	931	391	1577	1835	V		GRANIT BNE		0	0	0	MOLI	1991	S	
264	556	C	2	275	82	19	0	1825	V		RMI BNA		0	0	0	FRAG	1991	S	
264	556	C	2	276	114	51	0	1817	P		QUARSITA BNA		0	0	0	FRAC	1991	S	
264	556	C	2	277	162	138	0	1813	P		RMI BNA		0	0	0	FRAG	1991	S	
264	556	C	2	278	361	960	0	1793	P		CERAMICA INFORME		0	0	0		1991		
264	556	C	2	279	627	230	0	1826	P		ESQUIST BNA		0	0	0	FRAG	1991	S	
264	556	C	2	280	754	397	0	1834	SE		RMI BNA		0	0	0	FRAG	1991	S	
264	556	C	2	281	841	419	0	1828	NE		QUARS BNA		0	0	0	FRAC	1991	S	
264	556	C	2	282	164	154	0	1865	W		RMI BNA		0	0	0	FRAG	1991	S	
264	556	C	2	283	119	49	0	1869	V		CERAMICA INFORME		0	0	0		1991	S	
264	556	C	2	284	45	73	0	1868	NE		SILEX BNA		0	0	0	FRAC	1991	S	
264	556	C	3	285	321	777	0	1884	P		CERAMICA VORA		0	0	0		1991	S	
264	556	C	3	286	456	774	0	1955	E		RMI BNA		0	0	0	ALTERAT	1991	S	
264	556	C	3	287	902	906	0	1925	W		RMI BNA		0	0	0	FRAG	1991	S	
264	556	C	3	288	95	802	0	1975	N		QUARS BNA		0	0	0		1991	S	

BOBILA MADURELL  
MAS DURAN  
Objectes Coordenats C5  
Campanya 1991

c	c	C	N											ALTERACIONS	P	D			
uX	uY	O	I	NUM.	X	Y	Zsup	Zinf	ORIENT	PENDENT	MATERIA	OBJECTE	LONG	AMPL	ESPE	OBSERVACIONS	ANY	U	I
a	a	N	V														N	B	
d	d	J															T	U	
264	556	C	3	289	354	594	0	1975	E		CERAMICA APLICA		0	0	0	MUGRO	1991	S	
264	556	C	3	290	103	887	0	2000	W		CERAMICA INFORME		0	0	0		1991	S	
264	556	C	3	291	21	722	0	2010			OS INDET		0	0	0	3 FRAGS	1991	S	
264	556	C	3	292	940	544	0	1979			ORGANIC CARBO		0	0	0		1991		
264	556	C	3	293	803	697	0	1981	S		SORRENCA BNA		0	0	0	FRAG	1991	S	
264	556	C	3	294	827	477	0	2000	NE		OS DET		0	0	0	DENT 2 FRAGS	1991	S	
264	556	C	3	295	844	568	1920	2029	P		CALCARIA BNA		0	0	0	ALTERAT	1991	S	
264	556	C	3	296	883	641	0	2013	W		QUARS BNA		0	0	0	FRAC	1991	S	
264	556	C	3	297	602	633	0	2025			QUARS BNA		0	0	0	FRAG	1991	S	
264	556	C	3	299	892	95	0	2045	P		CERAMICA INFORME		0	0	0		1991	S	
264	556	C	3	300	722	262	0	2075	NE		CERAMICA VORA		0	0	0		1991	S	
264	556	C	3	301	821	454	0	2032	P		CERAMICA INFORME		0	0	0		1991	S	
264	556	C	3	302	756	451	0	2052	P		CALCARIA BNA		0	0	0	FRAG	1991	S	
264	556	C	3	303	427	528	0	2040	S		CERAMICA INFORME		0	0	0		1991	S	
264	556	C	3	304	734	729	0	2052	S		SORRENCA BNA		0	0	0	FRAG	1991	S	
264	556	C	3	305	813	683	0	2056	P		CERAMICA INFORME		0	0	0		1991	S	
264	556	C	3	306	468	459	0	2067	S		RMI BNA		0	0	0	FRAG	1991	S	
264	556	C	3	307	387	402	0	2049	P		SORRENCA BNA		0	0	0	FRAG	1991	S	
264	556	C	3	308	27	785	0	2040	E		OS INDET		0	0	0		1991	S	
264	556	C	3	309	955	42	0	2034	P		CERAMICA INFORME		0	0	0		1991	S	
264	556	C	3	310	770	352	0	2054	SE		RMI BNA		0	0	0	FRAC	1991	S	
264	556	C	3	311	562	232	0	2070	SW		CERAMICA INFORME		0	0	0	4 FRAGS	1991	S	
264	556	C	3	312	472	543	0	2089			CONGLOME BNA		0	0	0	5 FRAGS MICROCG	1991	S	
264	556	C	3	313	582	558	0	2090	P		CERAMICA INFORME		0	0	0		1991	S	
264	556	C	3	314	571	609	0	2085	S		CERAMICA VORA		0	0	0		1991	S	
264	556	C	3	315	735	550	0	2083	S		CERAMICA INFORME		0	0	0		1991	S	
264	556	C	3	316	773	607	0	2075	SW		CERAMICA INFORME		0	0	0	2 FRAGS	1991	S	
264	556	C	3	317	497	670	0	2093	P		CERAMICA INFORME		0	0	0		1991	S	
264	556	C	3	318	936	38	0	2060	W		RMI BNA		0	0	0		1991	S	
264	556	C	3	319	607	217	0	2082	S		RMI BNA		0	0	0		1991	S	
264	556	C	3	320	540	352	0	2105	P		RMI BNA		0	0	0	FRAG	1991	S	
264	556	C	3	321	676	396	0	2095	S		RMI BNA		0	0	0	FRAG	1991	S	
264	556	C	3	322	786	400	0	2068	S		RMI BP		0	0	0		1991	S	
264	556	C	3	323	767	658	0	2089			QUARS BPI		0	0	0		1991	S	
264	556	C	3	324	356	459	0	2095	P		RMI BNA		0	0	0	FRAG	1991	S	
264	556	C	3	325	14	274	0	2102	P		RMI BPI		0	0	0		1991	S	
264	556	C	3	326	670	211	0	2129	W		OS DET		0	0	0		1991	S	
264	556	C	3	327	636	241	0	2140	W		CONGLOME BNA		0	0	0	FRAG	1991	S	
264	556	C	3	328	757	423	0	2128	V		CERAMICA INFORME		0	0	0		1991	S	
264	556	C	3	329	771	448	0	2110	P		RMI BNA		0	0	0		1991	S	
264	556	C	3	330	664	443	0	2102	S		CERAMICA INFORME		0	0	0		1991	S	
264	556	C	3	331	551	328	0	2128	N		CONGLOME BNA		0	0	0	FRAG MICROCONGL	1991	S	
264	556	C	3	332	506	358	0	2126	P		CONGLOME BNA		0	0	0	FRAG MICROCONGL	1991	S	
264	556	C	3	333	479	413	0	2124	S		CONGLOME BNA		0	0	0	FRAG MICROCONGL	1991	S	
264	556	C	3	334	499	449	0	2108	P		RMI BNA		0	0	0	FRAG	1991	S	
264	556	C	3	335	501	499	0	2106	E		CONGLOME BNA		0	0	0	FRAG MICROCONGL	1991	S	
264	556	C	3	336	941	983	0	2131	V		RMI BNA		0	0	0	FRAG	1991	S	
264	556	C	3	337	502	150	2055	2132	S		RMI BNA		0	0	0	FRAC	1991	S	
264	556	C	3	338	916	51	0	2125			CERAMICA VORA		0	0	0	3 FRAGS	1991	S	
264	556	C	3	339	548	235	0	2152	SW		RMI BNA		0	0	0	FRAG	1991	S	

BOBILA MADURELL  
MAS DURAN  
Objectes Coordinats C5  
Campanya 1991

c	c	C	N											ALTERACIONS	P	D				
uX	uY	O	I	NUM.	X	Y	Zsup	Zinf	ORIENT	PENDENT	MATERIA	OBJECTE	LONG	AMPL	ESPE	OBSERVACIONS	ANY	U	I	
a	a	N	V															N	B	
d	d	J																T	U	
264	556	C	3		340	199	655	0	2149		ORGANIC	CARBO	0	0	0		1991	S		
264	556	C	3		342	687	981	0	2175	P	RMI	BNA	0	0	0	FRAG	1991	S		
264	556	C	3		343	739	895	0	2168	NW	RMI	BNA	0	0	0	FRAG	1991	S		
264	556	C	3		344	917	847	0	2195	SE	SORRENCA	BNA	0	0	0	FRAG	1991	S		
264	556	C	3		345	70	206	0	2183	SW	RMI	BNA	0	0	0	FRAG	1991	S		
264	556	C	3		346	406	232	0	2155	SW	CALCARIA	BNA	0	0	0	FRAG	1991	S		
264	556	C	3		347	410	179	0	2162	P	RMI	BNA	0	0	0	FRAG	1991	S		
264	556	C	3		348	387	700	0	2183	N	CERAMICA	VORA	0	0	0		1991	S		
264	556	C	3		349	271	744	0	2192	P	QUARS	BPI	0	0	0		1991	S		
264	556	C	3		350	375	977	0	2181	SW	QUARS	BNA	0	0	0	FRAG	1991	S		
264	556	C	3		351	397	123	0	2196		ORGANIC	CARBO	0	0	0		1991	S		
264	556	C	3		352	515	720	0	2215		ORGANIC	CARBO	0	0	0		1991	S		
264	556	C	3		353	513	10	0	2226	P	RMI	BNA	0	0	0		1991	S		
264	556	C	3		354	461	636	0	2269	SW	CERAMICA	PANXA	0	0	0		1991	S		
264	556	C	3		355	392	715	0	2266	W	RMI	BNA	0	0	0	FRAG	1991	S		
264	556	C	3		356	397	766	0	2245	W	CERAMICA	INFORME	0	0	0		1991	S		
264	556	C	3		357	473	831	0	2242	W	CERAMICA	INFORME	0	0	0	TOVOT	1991	S		
264	556	C	3		358	367	839	0	2258		ORGANIC	CARBO	0	0	0		1991	S		
264	556	C	3		359	620	762	0	2248	W	CERAMICA	INFORME	0	0	0		1991	S		
264	556	C	3		360	586	47	0	2308	E	QUARS	BNA	0	0	0		1991	S		
264	556	C	3		361	736	341	0	2315	NW	CERAMICA	INFORME	0	0	0		1991	S		
264	556	C	3		362	523	652	0	2302		ORGANIC	CARBO	0	0	0		1991	S		
264	556	C	3		363	423	912	0	2314	SW	CERAMICA	INFORME	0	0	0		1991	S		
264	556	C	3		364	500	913	0	2310	W	CERAMICA	INFORME	0	0	0		1991	S		
264	556	C	3		365	475	944	0	2294	P	GRANIT	BPI	0	0	0		1991	S		
264	556	C	3		366	549	890	0	2305	P	CERAMICA	INFORME	0	0	0		1991	S		
264	556	C	3		367	550	997	0	2290	W	RMI	BNA	0	0	0	FRAG	1991	S		
264	556	C	3		368	324	885	0	2320	SW	RMI	BP	0	0	0	FRAG	TERMIC	1991	S	
264	556	C	3		369	420	792	0	2321	W	CERAMICA	INFORME	0	0	0		1991	S		
264	556	C	3		370	588	528	0	2351	P	OS	DET	0	0	0	EI	1991	S		
264	556	C	3		371	666	266	0	2334	V	CALCARIA	BNA	0	0	0	FRAC	ALTERAT	1991	S	
264	556	C	3		372	676	627	0	2320		ORGANIC	CARBO	0	0	0		1991	S		
264	556	C	3		373	316	927	0	2355	S	CALCARIA	BNA	0	0	0	FRAC	1991	S		
264	556	C	3		374	247	921	0	2344	S	CONGLOME	BNA	0	0	0	FRAG	MICROCONGL	1991	S	
264	557	C			1	58	128	1170	1219	NE-SW	SW	RMI	BNA	0	0	0	FRAG	1991	S	
264	557	C			2	127	388	1174	1204	N-S	S	SORRENCA	BNA	0	0	0	FRAG	1991	S	
264	557	C			3	142	66	1203	1273	N-S	S	CONGLOME	BNA	0	0	0	MICROCONGLOME	1991	S	
264	557	C			5	548	74	1236	1246			CERAMICA	INFORME	0	0	0	2 FRAGS	1991	S	
264	557	C			6	592	314	1193	1218	NW-SE	SE	QUARS	BNA	0	0	0	FRAG	1991	S	
264	557	C			7	726	275	1911	1248	NE-SW	NE	CONGLOME	BNA	0	0	0	MICROCONGLOME	1991	S	
264	557	C			9	849	219	1228	1268			QUARS	BNA	0	0	0	FRAC	1991	S	
264	557	C			10	745	488	1203	1245	N-S	N	CALCARIA	BN1G	0	0	0		1991	S	
264	557	C			11	637	490	0	1215	V		CALCARIA	BNA	0	0	0	ALTERAT	1991		
264	557	C			12	839	592	1156	1182	E-W	S	CALCARIA	BNA	0	0	0	ALTERAT	1991	S	
264	557	C			13	644	662	1161	1181	N-S	SE	QUARS	BNA	0	0	0		1991	S	
264	557	C			14	60	901	1232	1270	N-S	NW	CONGLOME	BNA	0	0	0	MICROCONGLOME	1991	S	
264	557	C			15	96	868	1210	1249	NE-SW	NE	INDET	BNA	0	0	0	FRAG	1991	S	
264	557	C			16	144	875	1203	1258	NW-SE	NW	CALCARIA	BNA	0	0	0	FRAG	1991	S	
264	557	C			17	167	872	1207	1233	NW-SE	NW	QUARS	FRAG	0	0	0		1991		
264	557	C			18	224	171	1234	1280	N-S	S	RMI	BNA	0	0	0		1991	S	



BOBILA MADURELL  
MAS DURAN  
Objectes Coordenats C5  
Campanya 1991

c	c	C	N											ALTERACIONS			P	D	
uX	uY	O	I	NUM.	X	Y	Zsup	Zinf	ORIENT	PENDENT	MATERIA	OBJECTE	LONG	AMPL	ESPE	OBSERVACIONS	ANY	U	I
a	a	N	V														N	B	
d	d	J															T	U	
264	557	C		19	454	358	1202	1229	N-S	S	QUARS	BNA	0	0	0	FRAG	1991	S	
264	557	C		20	393	558	1198	1245	NE-SW		QUARS	BNA	0	0	0	FRAG	1991	S	
264	557	C		21	387	614	1193	1227	NE-SW	S	SORRENCA	BNA	0	0	0	FRAG	1991	S	
264	557	C		22	244	607	1208	1231	NW-SE	NW	SORRENCA	BNA	0	0	0	FRAG	1991	S	
264	557	C		23	123	593	1223	1230	N-S	P	INDET	BPI	0	0	0		1991	S	
264	557	C		24	94	668	1207	1237	NE-SW	S	CALCARIA	BNA	0	0	0	ALTERAT	1991	S	
264	557	C		25	148	755	1222	1257	N-S	N	RMI	BNA	0	0	0	FRAG	1991	S	
264	557	C		26	191	756	0	1210	N-S	N	RMI	BNA	0	0	0		1991	S	
264	557	C		27	350	956	1192	1220	NE-SW	NE	QUARS	BNA	0	0	0	FRAG	1991	S	
264	557	C		28	71	717	0	1280	E-W	E	CALCARIA	BNA	0	0	0	FRAG	1991	S	
264	557	C		29	550	762	0	1280	E-W	P	RMI	BNA	0	0	0	FRAG	1991	S	
264	557	C		30	434	221	0	1300		P	QUARS	BNA	0	0	0		1991	S	
264	557	C		31	95	328	0	1280			CERAMICA	INFORME	0	0	0		1991	S	
264	557	C		32	416	907	0	1285	N-S		CERAMICA	INFORME	0	0	0		1991	S	
264	557	C	2	33	777	943	0	1368		SW	SORRENCA	BNA	0	0	0		1991	S	
264	557	C	2	34	149	732	1230	1398		P	CALCARIA	BNA	0	0	0	FRAG	1991	S	
264	557	C	2	35	773	732	0	1379		P	RMI	BNA	0	0	0	FRAG	1991	S	
264	557	C	2	36	680	563	0	1370			CALCARIA	BNA	0	0	0	FRAC	1991	S	
264	557	C	2	37	725	44	0	1392			SORRENCA	BNA	0	0	0	FRAG	1991	S	
264	557	C	2	38	400	997	0	1353		N	RMI	BNA	0	0	0	FRAG	1991	S	
264	557	C	2	39	18	891	0	1352		V	INDET	BNA	0	0	0	FRAG	1991	S	
264	557	C	2	40	249	905	0	1367		P	RMI	BNA	0	0	0	FRAG	1991	S	
264	557	C	2	41	432	559	0	1392		SW	RMI	BNA	0	0	0	FRAG	1991	S	
264	557	C	2	42	954	229	0	1385		P	CERAMICA	INFORME	0	0	0		1991	S	
264	557	C	2	43	917	29	0	1391		W	CONGLOME	BNA	0	0	0	FRAG	1991	S	
264	557	C	2	44	987	509	0	1396		P	CERAMICA	INFORME	0	0	0		1991	S	
264	557	C	2	45	18	717	0	1439		S	SORRENCA	BNA	0	0	0	FRAG	1991	S	
264	557	C	2	46	599	591	0	1422		P	CERAMICA	INFORME	0	0	0		1991	S	
264	557	C	2	47	794	565	0	1425		P	SORRENCA	BNA	0	0	0	FRAG	1991	S	
264	557	C	2	48	38	343	0	1404		V	QUARSITA	BNA	0	0	0	FRAG	1991	S	
264	557	C	2	49	853	977	0	1453		P	QUARS	BNA	0	0	0	FRAG	1991	S	
264	557	C	2	50	679	902	0	1451		P	QUARSITA	BNA	0	0	0	FRAG	1991	S	
264	557	C	2	51	698	771	0	1444		P	QUARS	BPI	0	0	0		1991	S	
264	557	C	2	52	591	50	0	1454		P	SORRENCA	BNA	0	0	0		1991	S	
264	557	C	2	53	23	824	0	1451		P	QUARS	CODOL	0	0	0		1991	S	
264	557	C	2	54	17	779	0	1453		V	QUARSITA	BNA	0	0	0	FRAG	1991	S	
264	557	C	2	55	197	886	0	1454		P	SORRENCA	BNA	0	0	0	FRAG	1991	S	
264	557	C	2	56	262	910	0	1441		P	SORRENCA	BNA	0	0	0		1991	S	
264	557	C	2	57	137	917	0	1461		S	QUARS	BNA	0	0	0	FRAG	1991	S	
264	557	C	2	58	96	867	0	1470		P	QUARS	BNA	0	0	0	FRAG	1991	S	
264	557	C	2	59	359	663	0	1471		S	SORRENCA	BNA	0	0	0	FRAG	1991	S	
264	557	C	2	60	279	661	0	1495		E	SORRENCA	BNA	0	0	0	FRAG	1991	S	
264	557	C	2	61	66	166	0	1515		S	CERAMICA	INFORME	0	0	0		1991	S	
264	557	C	2	62	47	462	0	1480		S	CALCARIA	BNA	0	0	0	FRAG ALTERAT	1991	S	
264	557	C	2	63	245	446	0	1520		P	SORRENCA	FRAG	0	0	0		1991	S	
264	557	C	2	64	80	727	0	1509		V	CALCARIA	BN1G	0	0	0		1991	S	
264	557	C	2	65	641	371	0	1516		SW	QUARS	BNA	0	0	0	FRAG	1991	S	
264	557	C	2	66	646	657	0	1505		V	SORRENCA	BNA	0	0	0	FRAG	1991	S	
264	557	C	2	67	762	356	0	1510		V	CERAMICA	INFORME	0	0	0	TERRACUITA	1991	S	
264	557	C	2	68	821	436	0	1510		V	QUARS	BNA	0	0	0	FRAG	1991	S	

BOBILA MADURELL  
MAS DURAN  
Objectes Coordinats C5  
Campanya 1991

c	c	C	N											ALTERACIONS	P	D				
uX	uY	O	I	NUM.	X	Y	Zsup	Zinf	ORIENT	PENDENT	MATERIA	OBJECTE	LONG	AMPL	ESPE	OBSERVACIONS	ANY	U	I	
a	a	N	V														N	B		
d	d	J															T	U		
264	557	c	2	69	938	330	0	1519	P		CERAMICA	APLICA	0	0	0	LENGETA	1991	S		
264	557	c	2	70	771	643	0	1509	P		CERAMICA	INFORME	0	0	0		1991	S		
264	557	c	2	71	250	401	0	1542	S		QUARS	BNA	0	0	0	FRAG	1991	S		
264	557	c	2	72	137	538	0	1540	S		CERAMICA	INFORME	0	0	0		1991	S		
264	557	c	2	73	827	410	0	1537	S		SORRENCA	BNA	0	0	0	FRAG	1991	S		
264	557	c	2	74	974	212	0	1535	SW		SORRENCA	BNA	0	0	0	2 FRAGS	1991	S		
264	557	c	2	75	827	410	0	1562	P		QUARS	FRAG	0	0	0		1991			
264	557	c	2	76	974	212	0	1571	S		CALCARIA	BNA	0	0	0	FRAG	1991	S		
264	557	c	2	77	691	229	0	1558	P		QUARS	BPI	0	0	0		1991			
264	557	c	2	78	609	21	0	1575	W		SORRENCA	BP	0	0	0		1991	S		
264	557	c	2	79	743	424	0	1581	W		RMI	BNA	0	0	0	FRAG	1991	S		
264	557	c	2	80	76	23	0	1612	W		SORRENCA	BNA	0	0	0	FRAG	1991	S		
264	557	c	2	81	131	146	0	1592	SE		CALCARIA	BPF	0	0	0		1991	S		
264	557	c	2	82	76	23	0	1600	P		SORRENCA	BNA	0	0	0	NO RECUPERAT	1991	S		
264	557	c	2	83	359	205	0	1595			CERAMICA	INFORME	0	0	0		1991			
264	557	c	2	84	575	123	0	1595	W		SORRENCA	BNA	0	0	0		1991	S		
264	557	c	2	85	575	80	0	1575	SE		CERAMICA	INFORME	0	0	0		1991	S		
264	557	c	2	86	558	14	0	1599	W		CERAMICA	INFORME	0	0	0		1991	S		
264	557	c	2	87	54	190	0	1596	S		RMI	BNA	0	0	0	FRAG	1991	S		
264	557	c	2	88	366	29	0	1594	SW		INDET	BNA	0	0	0	FRAG	1991	S		
264	557	c	2	89	172	566	0	1585	P		CERAMICA	INFORME	0	0	0		1991	S		
264	557	c	2	90	555	377	0	1536	P		CERAMICA	INFORME	0	0	0	2 FRAGS	1991	S		
264	557	c	2	91	602	801	0	1586	P		CERAMICA	INFORME	0	0	0	NO RECUPERAT	1991	S		
264	557	c	2	92	761	948	0	1667	P		SILEX	BN2G	0	0	0		1991	S		
264	557	c	2	93	866	990	0	1650	N		CERAMICA	INFORME	0	0	0	VARIS FRAGS	1991	S		
264	557	c	2	94	674	554	0	1657	S		SORRENCA	BNA	0	0	0	FRAG	1991	S		
264	557	c	2	95	452	543	0	1677	S		CONGLOME	BNA	0	0	0	MICROCONGLOME	1991	S		
264	557	c	2	96	570	422	0	1691			ORGANIC	CARBO	0	0	0		1991	S		
264	557	c	2	97	248	536	0	1677			ORGANIC	CARBO	0	0	0		1991	S		
264	557	c	2	98	233	963	1582	1668	SW		ESQUIST	BNA	0	0	0	FRAG	1991	S		
264	557	c	2	99	433	951	1550	1656	SW		CONGLOME	BNA	0	0	0	FRAG	1991	S		
264	557	c	3	100	61	149	0	1751	P		SORRENCA	BNA	0	0	0	FRAG	1991	S		
264	557	c	3	101	974	651	0	1736	V		CERAMICA	INFORME	0	0	0	2 FRAGS	1991	S		
264	557	c	3	102	348	462	0	1757	SW		CERAMICA	VORA	0	0	0	FRAG	1991	S		
264	557	c	3	103	317	212	0	1801	P		RMI	BNA	0	0	0	FRAG	1991	S		
264	557	c	3	104	417	314	0	1781	SW		CERAMICA	INFORME	0	0	0	VARIS FRAGS	1991	S		
264	557	c	3	105	934	595	0	1772	V		CONGLOME	BNA	0	0	0	MICROCONGL FRAG	1991	S		
264	557	c	3	106	925	962	0	1760	V		OS	DET	0	0	0	DENT	1991	S		
264	557	c	3	107	900	606	0	1793	E		QUARS	BNA	0	0	0	FRAC	1991	S		
264	557	c	3	109	98	91	0	1808	SE		CERAMICA	INFORME	0	0	0	FRAG	1991	S		
264	557	c	3	110	535	120	0	1810	S		CERAMICA	INFORME	0	0	0		1991	S		
264	557	c	3	111	176	217	0	1694	P		ORGANIC	CARBO	0	0	0		1991	S		
264	557	c	3	112	616	340	0	1840	P		QUARS	BNA	0	0	0	FRAC	1991	S		
264	557	c	3	113	798	359	0	1841	SE		CERAMICA	INFORME	0	0	0		1991	S		
264	557	c	3	114	836	264	0	1843	P		CERAMICA	INFORME	0	0	0		1991	S		
264	557	c	3	115	801	97	0	1852	E		QUARS	BNA	0	0	0	FRAC	1991	S		
264	557	c	3	116	640	995	0	1883	NW		CALCARIA	BNA	0	0	0		1991	S		
264	557	c	3	117	748	288	0	1905	P		OS	INDET	0	0	0		1991	S		
264	557	c	3	118	837	313	0	1905	P		CERAMICA	INFORME	0	0	0		1991	S		
264	557	c	3	119	977	142	0	1902	W		OS	DET	0	0	0		1991	S		

BOBILA MADURELL  
MAS DURAN  
Objectes Coordinats C5  
Campanya 1991

c	c	C	N												ALTERACIONS		P	D			
uX	uY	O	I	NUM.	X	Y	Zsup	Zinf	ORIENT	PENDENT	MATERIA	OBJECTE	LONG	AMPL	ESPE	OBSERVACIONS	ANY	U	I		
a	a	N	V																	N	B
d	d	J																		T	U
264	557	c	3	120	202	604	0	1948	NW		CALCARIA	BNA	0	0	0	FRAG	1991	S			
264	557	c	3	121	821	591	0	1928			ORGANIC	CARBO	0	0	0		1991	S			
264	557	c	3	122	811	718	0	1942			QUARS	BP2G	0	0	0		1991	S			
264	557	c	3	123	807	651	0	1945	SE		CERAMICA	VORA	0	0	0		1991	S			
264	557	c	3	124	795	61	0	1962	P		OS	INDET	0	0	0	2 FRAGS	1991	S			
264	557	c	3	125	720	151	0	1957	S		RMI	BNA	0	0	0	FRAG	1991	S			
264	557	c	3	126	916	902	0	1970	S		CONGLOME	BNA	0	0	0	MICROCONGL	FRAG	1991	S		
264	557	c	3	127	782	762	0	2029	P		RMI	BNA	0	0	0	FRAG	1991	S			
264	557	c	3	128	748	67	0	2083	N		CONGLOME	BNA	0	0	0	MICROCONGL	FRAG	1991	S		
264	557	c	3	129	822	92	0	2086	P		TOVOT	FRAG	0	0	0		1991	S			
264	557	c	3	130	656	221	0	2123	P		OS	DET	0	0	0		1991	S			
264	557	c	3	131	705	144	0	2112	S		CERAMICA	INFORME	0	0	0	ARGILA	CUITA	1991	S		
264	557	c	3	132	707	716	0	2144	S		SORRENCA	BNA	0	0	0	FRAG	1991	S			
264	557	c	3	133	774	668	0	2136	P		QUARS	BNA	0	0	0	FRAC	1991	S			
264	557	c	3	134	355	894	0	2153	S		RMI	BNA	0	0	0	FRAG	1991	S			
264	557	c	3	135	263	807	0	2184	S		QUARS	BPI	0	0	0		1991	S			
264	557	c	3	136	904	828	0	2159	S		RMI	BNA	0	0	0	FRAG	1991	S			
264	557	c	3	137	985	231	0	2156	P		CONGLOME	BNA	0	0	0	FRAG	1991	S			
264	557	c	3	138	897	175	0	2163	W		OS	DET	0	0	0		1991	S			
264	557	c	3	139	875	774	0	2174	SW		CERAMICA	INFORME	0	0	0	ARGILA	CUITA	1991	S		
264	557	c	3	140	917	750	0	2194	SW		RMI	BNA	0	0	0	FRAG	1991	S			
264	557	c	3	141	927	124	0	2199	N		RMI	BNA	0	0	0	FRAG	1991	S			
264	557	c	3	142	101	999	0	2220	SE		CALCARIA	BNA	0	0	0	FRAG	ALTERAT	1991	S		
264	557	c	3	143	228	999	0	2192	P		CALCARIA	BNA	0	0	0		1991	S			
264	557	c	3	144	251	964	0	2177	NW		SORRENCA	BNA	0	0	0	FRAG	1991	S			
264	557	c	3	145	190	902	0	2216	SW		QUARSITA	BNA	0	0	0		1991	S			
264	557	c	3	146	131	938	0	2225	P		QUARS	BNA	0	0	0	FRAC	1991	S			
264	557	c	3	147	266	917	0	2196	S		SORRENCA	BNA	0	0	0		1991	S			
264	557	c	3	148	84	887	0	2240	P		SORRENCA	BNA	0	0	0		1991	S			
264	557	c	3	149	104	827	0	2245	W		RMI	BNA	0	0	0	FRAG	1991	S			
264	557	c	3	150	177	852	0	2230	P		RMI	BNA	0	0	0	FRAG	1991	S			
264	557	c	3	151	165	776	0	2207	NW		RMI	BNA	0	0	0	FRAG	1991	S			
264	557	c	3	152	90	722	0	2255	SE		SORRENCA	BNA	0	0	0	FRAG	1991	S			
264	557	c	3	153	408	444	0	2230	S		RMI	BNA	0	0	0	FRAG	1991	S			
264	557	c	3	154	485	432	0	2230	S		RMI	BNA	0	0	0	FRAG	1991	S			
264	557	c	3	155	491	345	0	2225	SE		CERAMICA	INFORME	0	0	0		1991	S			
264	557	c	3	156	697	126	0	2197	SE		QUARS	BNA	0	0	0	FRAG	1991	S			
264	557	c	3	157	779	147	0	2193	NE		CONGLOME	BNA	0	0	0	MICROCONGLOME	1991	S			
264	557	c	3	158	207	913	0	2225	SW		CERAMICA	APLICA	0	0	0	MAMELO	1991	S			
264	557	c	3	159	491	78	0	2251	SW		CERAMICA	APLICA	0	0	0	MAMELO	1991	S			
264	557	c	3	160	437	113	0	2255	SW		CERAMICA	VORA	0	0	0		1991	S			
264	557	c	3	161	458	172	0	2255	SW		CERAMICA	INFORME	0	0	0	4 FRAGS	1991	S			
264	557	c	3	162	441	330	0	2246	V		CERAMICA	INFORME	0	0	0		1991	S			
264	557	c	3	163	147	516	0	2245	E		RMI	BNA	0	0	0	FRAG	1991	S			
264	557	c	3	164	44	557	0	2254	P		QUARS	BPI	0	0	0		1991	S			
264	557	c	3	165	34	964	0	0	P		QUARSITA	BPF	0	0	0		1991	S			
264	557	c	3	166	132	647	0	2253	P		OS	DET	0	0	0		1991	S			
264	557	c	3	167	109	594	0	2265	P		RMI	BNA	0	0	0		1991	S			
264	557	c	3	168	174	584	0	2253			CERAMICA	INFORME	0	0	0	2 FRAGS	1991	S			
264	557	c	3	169	89	531	0	2287	P		RMI	BNA	0	0	0		1991	S			

BOBILA MADURELL  
MAS DURAN  
Objectes Coordenats C5  
Campanya 1991

													ALTERACIONS		P D					
c	c	C	N											ANY	U	I				
uX	uY	O	I	NUM.	X	Y	Zsup	Zinf	ORIENT	PENDENT	MATERIA	OBJECTE	LONG	AMPL	ESPE	OBSERVACIONS	N	B		
a	a	N	V																T	U
d	d	J																		
264	557	C	3	170	132	458	0	2262	SW		CONGLOME	BNA	0	0	0	MICROCONGLOME	1991	S		
264	557	C	3	171	499	259	0	2257	SW		OS	DET	0	0	0		1991	S		
264	557	C	3	172	457	166	0	2260	SW		OS	DET	0	0	0		1991	S		
264	557	C	3	173	495	117	0	2264	SW		SORRENCA	BNA	0	0	0	FRAG	1991	S		
264	557	C	3	174	60	918	0	2303	P		INDET	BNA	0	0	0		1991	S		
264	557	C	3	175	417	41	0	2276	P		CERAMICA	VORA	0	0	0		1991	S		
264	557	C	3	176	132	538	0	2305	P		SORRENCA	BNA	0	0	0		1991	S		
264	557	C	3	177	142	459	0	2300	SW		CERAMICA	INFORME	0	0	0		1991	S		
264	557	C	3	178	164	449	0	2295	V		CERAMICA	INFORME	0	0	0		1991	S		
264	557	C	3	179	197	414	0	2273	W		INDET	BNA	0	0	0		1991	S		
264	557	C	3	180	161	367	0	2296	P		CERAMICA	INFORME	0	0	0	TOVOT	1991	S		
264	557	C	3	181	491	211	0	2304	P		CALCARIA	BNA	0	0	0		1991	S		
264	557	C	3	182	313	127	0	2281	P		CONGLOME	BNA	0	0	0	FRAG MICROCONGL	1991	S		
264	557	C	3	183	158	112	0	2294	SW		CALCARIA	BNA	0	0	0		1991	S		
264	557	C	3	184	295	50	0	2306	E		SORRENCA	BNA	0	0	0	ALTERAT	1991	S		
264	557	C	3	185	464	46	0	2293	S		RMI	BNA	0	0	0	FRAG	1991	S		
264	557	C	3	186	198	594	0	2335	V		CONGLOME	BNA	0	0	0	MICROCONGLOME	1991	S		
264	557	C	3	187	419	103	0	2303	N		INDET	BNA	0	0	0	FRAG ALTERAT	1991	S		
264	557	C	3	188	111	33	0	2314	W		CERAMICA	APLICA	0	0	0	MUGRO	1991	S		
264	557	C	3	189	98	138	0	2359	V		QUARS	BNA	0	0	0		1991	S		
264	557	C	3	190	317	116	0	2373	P		SORRENCA	BNE	0	0	0	FRAG ALTERAT	1991	S		
264	557	C	3	191	28	336	0	2364	W		CONGLOME	BNA	0	0	0	FRAG MICROCONGL	1991	S		
264	557	C	3	192	210	269	0	2370	P		CERAMICA	APLICA	0	0	0	CORDO/VORA	1991	S		
264	557	C	3	193	203	305	0	2358			CALCARIA	BPI	0	0	0		1991	S		
264	557	C	3	194	300	344	0	2360	W		QUARSITA	BNA	0	0	0	FRAC	1991	S		
264	557	C	3	195	280	413	0	2370	S		SORRENCA	BNA	0	0	0	ALTERAT	1991	S		
264	557	C	3	196	316	460	0	2359	P		CONGLOME	BNA	0	0	0	FRAG MICROCONGL	1991	S		
264	557	C	3	197	140	548	0	2387	S		RMI	BNA	0	0	0	FRAG	1991	S		
264	557	C	3	198	153	403	0	2405	W		QUARSITA	BNA	0	0	0	FRAG	1991	S		
264	557	C	3	199	204	504	0	2368	W		SILEX	BNA	0	0	0	FRAC	1991	S		
264	557	C	3	200	284	523	0	2354	P		QUARS	BNA	0	0	0	FRAG	1991	S		
264	557	C	3	201	13	416	0	2419			CERAMICA	INFORME	0	0	0	TERRA CUITA	1991	S		
264	557	C	3	202	74	210	0	2424	N		QUARS	BNA	0	0	0		1991	S		
264	557	C	3	203	39	491	0	2432	SE		OS	DET	0	0	0	EI	1991	S		
264	558	C		1	46	151	0	1220	NE-SW	SW	RMI	BNA	0	0	0	FRAG	1991	S		
264	558	C		2	450	82	1225	1170	NW-SE	SW	INDET	FRAG	0	0	0		1991	S		
264	558	C		3	498	97	0	1160	N-S	P	QUARS	FRAG	0	0	0		1991	S		
264	558	C		4	479	188	0	1165	NW-SE	V	QUARS	CODOL	0	0	0		1991	S		
264	558	C		5	341	254	0	1165	NE-SW	V	GRANIT	CODOL	0	0	0		1991	S		
264	558	C		6	604	261	0	1150	E-W	S	QUARSITA	FRAG	0	0	0		1991	S		
264	558	C		7	252	591	0	1134	NW-SE	SW	CERAMICA	INFORME	0	0	0		1991	S		
264	558	C		8	372	643	0	1150	NW-SE	P	INDET	FRAG	0	0	0		1991	S		
264	558	C		9	101	83	1247	1303	S		RMI	BNA	0	0	0	FRAG	1991	S		
264	558	C		10	222	322	0	1290	V		SILEX	BPI	0	0	0	CORTICAL	1991	S		
264	558	C		11	503	412	1240	1266	NW		RMI	BNA	0	0	0	FRAG	1991	S		
264	558	C		12	891	424	0	1265	V		QUARS	BNA	0	0	0		1991	S		
264	558	C		13	80	537	0	1305	P		INDET	BNA	0	0	0		1991	S		
264	558	C		14	620	593	0	1290			RMI	BNA	0	0	0	FRAG	1991	S		
264	558	C		15	776	647	0	1312	SE		RMI	BNA	0	0	0		1991	S		
264	558	C		16	157	49	0	1320	SW		SORRENCA	BNA	0	0	0	FRAG	1991	S		

BOBILA MADURELL  
MAS DURAN  
Objectes Coordenats C5  
Campanya 1991

c	c	C	N											ALTERACIONS			P	D	
uX	uY	O	I	NUM.	X	Y	Zsup	Zinf	ORIENT	PENDENT	MATERIA	OBJECTE	LONG	AMPL	ESPE	OBSERVACIONS	ANY	U	I
a	a	N	V															N	B
d	d	J																T	U
264	558	C	2	17	421	457	0	1369			CERAMICA	INFORME	0	0	0		1991	S	
264	558	C	2	18	575	293	0	1378	P		CALCARIA	BNA	0	0	0		1991	S	
264	558	C	2	19	960	165	0	1367	E		INDET	BNA	0	0	0	FRAG	1991	S	
264	558	C	2	20	235	50	0	1385	V		SORRENCA	BNA	0	0	0		1991	S	
264	558	C	2	21	498	243	0	1393	W		SORRENCA	BNA	0	0	0		1991	S	
264	558	C	2	22	664	98	0	1402	W		QUARSITA	BNA	0	0	0	FRAG	1991	S	
264	558	C	2	23	889	105	0	1399	P		CALCARIA	CODOLF	0	0	0		1991		
264	558	C	2	24	340	10	0	1411	P		RMI	BNA	0	0	0	FRAG	1991	S	
264	558	C	2	25	49	308	0	1418	V		CONGLOME	BNA	0	0	0	FRAG MICROCONGL	1991	S	
264	558	C	2	26	211	453	0	1412	E		QUARS	BNA	0	0	0		1991	S	
264	558	C	2	28	699	315	0	1426	P		QUARS	BNA	0	0	0	FRAG	1991	S	
264	558	C	2	29	739	267	0	1413	P		ESQUIST	BNA	0	0	0	FRAG	1991	S	
264	558	C	2	30	783	259	0	1414	N		CERAMICA	INFORME	0	0	0		1991	S	
264	558	C	2	31	834	156	0	1421	W		CERAMICA	INFORME	0	0	0		1991	S	
264	558	C	2	32	842	471	0	1391	W		QUARS	BPI	0	0	0		1991	S	
264	558	C	2	33	835	542	0	1402	NW		SORRENCA	BNA	0	0	0	ALTERAT	1991	S	
264	558	C	2	34	775	769	0	1399	V		CERAMICA	INFORME	0	0	0		1991	S	
264	558	C	2	35	41	320	0	1394	V		QUARS	BNA	0	0	0	FRAG	1991	S	
264	558	C	2	36	60	987	0	1406			OS	INDET	0	0	0	MICRO	1991	S	
264	558	C	2	37	61	789	0	1420	V		QUARS	BNA	0	0	0	FRAG	1991	S	
264	558	C	2	38	21	934	0	1425	P		INDET	BNA	0	0	0	FRAG	1991	S	
264	558	C	2	39	287	991	0	1398	S		RMI	BNA	0	0	0	FRAG	1991	S	
264	558	C	2	40	670	931	0	1403			CERAMICA	INFORME	0	0	0		1991	S	
264	558	C	2	41	921	53	0	1499	P		CALCARIA	BNA	0	0	0	FRAG	1991	S	
264	558	C	2	42	645	97	0	1370	E		INDET	FRAG	0	0	0		1991		
264	558	C	2	43	921	53	0	1414	P		QUARS	FRAG	0	0	0		1991		
264	558	C	2	44	285	82	0	1396	N		SORRENCA	FRAG	0	0	0		1991		
264	558	C	2	45	633	24	0	1408	P		CERAMICA	INFORME	0	0	0		1991		
264	558	C	2	46	832	157	0	1439	SE		SORRENCA	BNA	0	0	0	FRAG	1991	S	
264	558	C	2	47	622	774	0	1441	SE		OS	INDET	0	0	0		1991	S	
264	558	C	2	48	654	759	0	1443	E		OS	INDET	0	0	0		1991	S	
264	558	C	2	49	632	739	0	1436	E		OS	INDET	0	0	0		1991	S	
264	558	C	2	50	835	951	0	1437	E		SORRENCA	BNA	0	0	0	FRAG	1991	S	
264	558	C	2	51	864	755	0	1426	P		CALCARIA	BNA	0	0	0		1991	S	
264	558	C	2	52	911	611	0	1416	S		SORRENCA	BNA	0	0	0	FRAG	1991	S	
264	558	C	2	53	759	705	0	1422	P		QUARS	BNA	0	0	0	FRAG	1991	S	
264	558	C	2	54	554	811	0	1444	E		QUARS	BNA	0	0	0		1991	S	
264	558	C	2	55	559	769	0	1439	S		SORRENCA	BNA	0	0	0	FRAG	1991	S	
264	558	C	2	56	577	503	0	1426	NE		SORRENCA	BNA	0	0	0		1991	S	
264	558	C	2	57	249	125	0	1435	S		CALCARIA	BNA	0	0	0	FRAC	1991	S	
264	558	C	2	58	485	221	0	1456	NW		CERAMICA	INFORME	0	0	0	2 FRAGS	1991	S	
264	558	C	2	59	166	893	0	1448	V		QUARS	BNA	0	0	0	FRAG	1991	S	
264	558	C	2	60	653	747	0	1485	V		SORRENCA	BNA	0	0	0	FRAG	1991	S	
264	558	C	2	61	948	840	0	1437	P		SORRENCA	BNA	0	0	0	FRAG	1991	S	
264	558	C	2	62	307	596	0	1444	SE		SORRENCA	BNA	0	0	0	FRAG	1991	S	
264	558	C	2	63	309	323	0	1446	E		QUARS	BN1G	0	0	0		1991	S	
264	558	C	2	64	873	764	0	1453	W		SORRENCA	BNA	0	0	0	FRAG	1991	S	
264	558	C	2	65	486	474	0	1465	E		ESQUIST	BNA	0	0	0	FRAG	1991	S	
264	558	C	2	66	608	415	0	1484	V		SILEX	BNA	0	0	0	FRAC	1991	S	
264	558	C	2	67	610	394	0	1485	V		QUARS	BNA	0	0	0	FRAG	1991	S	

BOBILA MADURELL  
MAS DURAN  
Objectes Coordenats C5  
Campanya 1991

c c C N												ALTERACIONS			P D				
uX	uY	O	I	NUM.	X	Y	Zsup	Zinf	ORIENT	PENDENT	MATERIA	OBJECTE	LONG	AMPL	ESPE	OBSERVACIONS	ANY	U	I
a	a	N	V															N	B
d	d	J																T	U
264	558	C	2	68	654	397	0	1493	P		RMI	BNA	0	0	0	FRAG	1991	S	
264	558	C	2	69	967	934	0	1474	E		QUARS	BNA	0	0	0	FRAC	1991	S	
264	558	C	2	70	866	947	0	1460	P		SORRENCA	BNA	0	0	0	FRAG	1991	S	
264	558	C	2	71	691	879	0	1452	P		SORRENCA	BNA	0	0	0	FRAG	1991	S	
264	558	C	2	72	793	823	0	1456	N		ESQUIST	BNA	0	0	0	FRAG	1991	S	
264	558	C	2	73	797	746	0	1466	NE		CONGLOME	BNA	0	0	0	MICROCONGL. FRAG	1991	S	
264	558	C	2	74	982	654	0	1511	V		CALCARIA	BNA	0	0	0	2 FRAGS	1991	S	
264	558	C	2	75	632	837	0	1443	P		CERAMICA	INFORME	0	0	0		1991	S	
264	558	C	2	76	684	808	0	1444	V		CALCARIA	BNA	0	0	0	FRAG	1991	S	
264	558	C	2	77	646	750	0	1455	P		CERAMICA	INFORME	0	0	0		1991	S	
264	558	C	2	78	444	880	0	1472	V		OS	INDET	0	0	0	4 FRAGS	1991	S	
264	558	C	2	79	355	810	0	1473	P		CERAMICA	INFORME	0	0	0		1991	S	
264	558	C	2	80	330	770	0	1475	V		CERAMICA	APLICA	0	0	0	MUGRO	1991	S	
264	558	C	2	81	341	658	0	1487	P		QUARS	BNA	0	0	0	FRAC	1991	S	
264	558	C	2	83	406	457	0	1472	W		RMI	BNA	0	0	0	FRAG	1991	S	
264	558	C	2	84	227	337	0	1487	P		CERAMICA	INFORME	0	0	0		1991	S	
264	558	C	2	85	430	352	0	1476	P		RMI	BNA	0	0	0	FRAG	1991	S	
264	558	C	2	86	297	241	0	1478	V		SORRENCA	BNA	0	0	0		1991	S	
264	558	C	2	87	311	138	0	1449	P		ESQUIST	BNA	0	0	0	FRAG	1991	S	
264	558	C	2	88	471	39	0	1469	N		QUARS	BNA	0	0	0	FRAC	1991	S	
264	558	C	2	89	736	934	0	1463	E-W	P	QUARSITA	BPF	0	0	0		1991	S	
264	558	C	2	91	386	980	0	1460	N-S	P	CERAMICA	VORA	0	0	0		1991	S	
264	558	C	2	92	261	981	0	1467	N-S	S	ESQUIST	BNA	0	0	0	FRAG	1991	S	
264	558	C	2	93	45	946	0	1473	NW-SE	V	ESQUIST	BNA	0	0	0		1991	S	
264	558	C	2	94	164	853	0	1460	E-W	W	QUARSITA	BNA	0	0	0	FRAG	1991	S	
264	558	C	2	95	533	851	0	1484	NW-SE	V	CALCARIA	BNA	0	0	0	FRAC	1991	S	
264	558	C	2	96	115	708	0	1475	NW-SE	P	RMI	BNA	0	0	0	FRAG	1991	S	
264	558	C	2	97	179	664	0	1487	E-W	P	QUARS	BPI	0	0	0		1991	S	
264	558	C	2	98	176	450	0	1485	E-W	E	QUARS	BNA	0	0	0	FRAC	1991	S	
264	558	C	2	99	107	420	0	1485	E-W	E	RMI	BNA	0	0	0	FRAG	1991	S	
264	558	C	2	100	235	23	0	1465	E-W	P	CERAMICA	INFORME	0	0	0		1991	S	
264	558	C	2	101	270	23	0	1473	N-S	P	CERAMICA	INFORME	0	0	0		1991	S	
264	558	C	2	102	225	955	0	1492	N-S	S	QUARS	BNA	0	0	0	FRAC	1991	S	
264	558	C	2	103	948	940	0	1489		P	ESQUIST	BNA	0	0	0	FRAG	1991	S	
264	558	C	2	104	825	963	0	1500		V	SORRENCA	BNA	0	0	0		1991	S	
264	558	C	2	105	714	952	0	1488		V	RMI	BNA	0	0	0	FRAG	1991	S	
264	558	C	2	106	633	950	0	1480		P	SORRENCA	BNA	0	0	0	FRAG	1991	S	
264	558	C	2	107	541	927	0	1485		P	QUARS	BNA	0	0	0		1991	S	
264	558	C	2	108	249	927	0	1504		NE	ESQUIST	BNA	0	0	0	FRAG	1991	S	
264	558	C	2	109	120	844	0	1485		P	SILEX	BPI	0	0	0		1991	S	
264	558	C	2	110	621	911	0	1490		E	ESQUIST	BNA	0	0	0	FRAG	1991	S	
264	558	C	2	111	858	903	0	1482		P	INDET	BNA	0	0	0	FRAG	1991	S	
264	558	C	2	112	816	726	0	1475		NE	RMI	BNA	0	0	0	FRAG	1991	S	
264	558	C	2	113	619	751	0	1492		SE	RMI	BNA	0	0	0	FRAG	1991	S	
264	558	C	2	114	442	773	0	1502		V	OS	INDET	0	0	0		1991	S	
264	558	C	2	115	122	756	0	1488		P	SILEX	BNA	0	0	0	FRAC	1991	S	
264	558	C	2	116	70	653	0	1486		N	CALCARIA	BPF	0	0	0		1991	S	
264	558	C	2	117	314	646	0	1492		P	CERAMICA	INFORME	0	0	0		1991	S	
264	558	C	2	118	804	600	0	1496		S	ESQUIST	BNA	0	0	0		1991	S	
264	558	C	2	119	671	537	0	1490			QUARS	BNA	0	0	0	FRAG	1991	S	

BOBILA MADURELL  
MAS DURAN  
Objectes Coordenats C5  
Campanya 1991

c	c	C	N									ALTERACIONS	P	D					
uX	uY	O	I	NUM.	X	Y	Zsup	Zinf	ORIENT	PENDENT	MATERIA	OBJECTE	LONG	AMPL	ESPE	OBSERVACIONS	ANY	U	I
a	a	N	V															N	B
d	d	J																T	U
264	558	c	2	120	56	588	0	1482			ESQUIST	BNA	0	0	0		1991	S	
264	558	c	2	121	362	464	0	1505	P		QUARS	BPI	0	0	0		1991	S	
264	558	c	2	122	508	330	0	1501	V		CERAMICA	INFORME	0	0	0		1991	S	
264	558	c	2	123	37	313	0	1502	E		RMI	BNA	0	0	0		1991	S	
264	558	c	2	124	574	152	0	1495	V		QUARS	BNA	0	0	0	FRAG	1991	S	
264	558	c	2	125	244	481	0	1500	W		SORRENCA	BNA	0	0	0	FRAG	1991	S	
264	558	c	2	126	457	340	0	1510	P		QUARS	BNA	0	0	0		1991	S	
264	558	c	2	127	103	979	0	1505	N		RMI	BNA	0	0	0	FRAG	1991	S	
264	558	c	2	128	78	872	0	1485	E		CALCARIA	BNA	0	0	0	FRAG	1991	S	
264	558	c	2	129	213	880	0	1515	P		SORRENCA	BNA	0	0	0	FRAG	1991	S	
264	558	c	2	130	353	987	0	1515	P		CALCARIA	BNA	0	0	0	FRAG ALTERAT	1991	S	
264	558	c	2	131	452	980	0	1520	V		SORRENCA	BNA	0	0	0	FRAG	1991	S	
264	558	c	2	132	567	917	0	1513	NE		QUARS	BNA	0	0	0	FRAG	1991	S	
264	558	c	2	133	657	938	0	1511	V		SILEX	BN1G	0	0	0		1991	S	
264	558	c	2	135	653	713	0	1489	S		CALCARIA	BP	0	0	0		1991	S	
264	558	c	2	136	694	699	0	1504	P		SORRENCA	BNA	0	0	0	FRAG	1991	S	
264	558	c	2	137	641	650	0	1513	E		SORRENCA	BNA	0	0	0	FRAG	1991	S	
264	558	c	2	138	649	605	0	1510	SE		CERAMICA	VORA	0	0	0		1991	S	
264	558	c	2	139	781	728	0	1507	P		ESQUIST	BNA	0	0	0	FRAG	1991	S	
264	558	c	2	140	754	677	0	1504	P		CERAMICA	VORA	0	0	0	2 FRAGS	1991	S	
264	558	c	2	141	785	664	0	1504	P		CERAMICA	VORA	0	0	0		1991	S	
264	558	c	2	144	870	778	0	1503	P		RMI	BNA	0	0	0	FRAG	1991	S	
264	558	c	2	145	138	714	0	1510	N		CONGLOME	BNA	0	0	0	MICROCONFL FRAG	1991	S	
264	558	c	2	146	935	692	0	1499	P		QUARS	BP	0	0	0		1991	S	
264	558	c	2	147	155	971	0	1525	NW		CERAMICA	INFORME	0	0	0	2 FRAGS	1991	S	
264	558	c	2	148	150	706	0	1517	SE		QUARS	BPI	0	0	0		1991	S	
264	558	c	2	149	260	790	0	1520	P		CERAMICA	INFORME	0	0	0		1991	S	
264	558	c	2	150	890	894	0	1515	S		SORRENCA	BNA	0	0	0	FRAG ALTERAT	1991	S	
264	558	c	2	151	379	777	0	1540	P		OS	DET	0	0	0		1991	S	
264	558	c	2	152	500	954	0	1514	S		SORRENCA	BNA	0	0	0	FRAG	1991	S	
264	558	c	2	153	660	851	0	1524	V		QUARS	BNA	0	0	0	FRAG	1991	S	
264	558	c	2	154	616	709	0	1524	P		QUARS	BNA	0	0	0	FRAG	1991	S	
264	558	c	2	155	578	557	0	1524	P		SORRENCA	BP	0	0	0	FRAG	1991	S	
264	558	c	2	156	315	494	0	1531	S		CERAMICA	INFORME	0	0	0	3 FRAGS	1991	S	
264	558	c	2	157	755	797	0	1520	E		SORRENCA	BNA	0	0	0	FRAG ALTERAT	1991	S	
264	558	c	2	158	49	777	0	1505	SW		QUARS	BNA	0	0	0	FRAG	1991	S	
264	558	c	2	159	897	866	0	1590			OS	DET	0	0	0		1991	S	
264	558	c	2	160	798	905	0	1545	NE		QUARSITA	BNA	0	0	0	FRAG	1991	S	
264	558	c	2	161	782	848	0	1540	NE		SORRENCA	BNA	0	0	0		1991	S	
264	558	c	2	162	651	900	0	1540	P		CONGLOME	BNA	0	0	0	MICROCONGLOME	1991	S	
264	558	c	2	163	641	810	0	1545	V		RMI	BNA	0	0	0	FRAG	1991	S	
264	558	c	2	164	614	777	0	1535	N		CERAMICA	INFORME	0	0	0		1991	S	
264	558	c	2	165	134	809	0	1535	S		SORRENCA	BPF	0	0	0	FRAG	1991	S	
264	558	c	2	166	713	808	0	1565	NE		CERAMICA	INFORME	0	0	0		1991	S	
264	558	c	2	167	640	779	0	1573	N		CERAMICA	INFORME	0	0	0		1991	S	
264	558	c	2	168	663	765	0	1578	E		CERAMICA	INFORME	0	0	0		1991	S	
264	558	c	2	169	763	899	0	1590	NW		CERAMICA	VORA	0	0	0		1991	S	
264	558	c	2	170	530	896	0	1613	N		QUARS	BNA	0	0	0	FRAG	1991	S	
264	558	c	2	171	595	888	0	1617	N		QUARS	BNA	0	0	0	FRAG	1991	S	
264	558	c	2	172	446	399	0	1630	SE		QUARS	BNA	0	0	0	FRAG	1991	S	

BOBILA MADURELL  
MAS DURAN  
Objectes Coordenats C5  
Campanya 1991

c uX a d	c uY a d	C O N V J	M I N V	NUM.	X	Y	Zsup	Zinf	ORIENT	PENDENT	MATERIA	OBJECTE	LONG	AMPL	ESPE	ALTERACIONS OBSERVACIONS	P D I B U T
264	558	C	2	173	359	343	1550	1639	SW		CONGLOME	BNA	0	0	0	MICROCONGL FRAG	1991 S
264	558	C	3	174	307	259	0	1730	P		RMI	BNA	0	0	0	FRAG	1991 S
264	558	C	3	175	907	34	0	1775	P		QUARS	BNA	0	0	0	FRAC	1991 S
264	558	C	3	176	384	8	0	1895	P		RMI	BNA	0	0	0		1991 S
264	558	C	3	177	502	666	0	1938	E		CERAMICA	INFORME	0	0	0	FRAG	1991 S
264	558	C	3	178	60	311	0	1989	W		RMI	BNA	0	0	0	FRAG	1991 S
264	558	C	3	179	241	202	0	2010	P		CERAMICA	INFORME	0	0	0		1991 S
264	558	C	3	180	809	400	0	2024	W		CERAMICA	INFORME	0	0	0		1991 S
264	558	C	3	181	749	9	0	2062	W		RMI	BNA	0	0	0	FRAG	1991 S
264	558	C	3	182	581	124	0	2059	W		RMI	BNA	0	0	0		1991 S
264	558	C	3	183	621	184	0	2048	NW		QUARS	BNA	0	0	0	FRAC	1991 S
264	558	C	3	184	816	334	0	2066	SE		CONGLOME	BNA	0	0	0		1991 S
264	558	C	3	185	870	282	0	2089	W		CONGLOME	BNA	0	0	0	MICROCONGLOME	1991 S
264	558	C	3	186	723	571	0	2068	NW		RMI	BNA	0	0	0		1991 S
264	558	C	3	187	165	651	0	2041	N		CERAMICA	VORA	0	0	0		1991 S
264	558	C	3	188	16	781	0	2051	P		OS	DET	0	0	0		1991 S
264	558	C	3	189	53	979	0	2056	P		CERAMICA	INFORME	0	0	0		1991 S
264	558	C	3	190	108	946	0	2064	P		CERAMICA	INFORME	0	0	0		1991 S
264	558	C	3	191	146	949	0	2064	E		CERAMICA	INFORME	0	0	0		1991 S
264	558	C	3	192	333	158	0	2103	W		CERAMICA	INFORME	0	0	0	VARIS FRAGS	1991 S
264	558	C	3	193	754	160	0	2089	S		SORRENCA	BNA	0	0	0	ALTERAT	1991 S
264	558	C	3	194	626	819	0	2108	E		CONGLOME	BNA	0	0	0	MICROCONGLOME	1991 S
264	558	C	3	195	733	873	0	2086	E		RMI	BNA	0	0	0	FRAG	1991 S
264	558	C	3	196	758	820	0	2087	W		RMI	BNA	0	0	0		1991 S
264	558	C	3	197	369	99	0	2135	W		QUARS	BNA	0	0	0	FRAG	1991 S
264	558	C	3	198	698	32	0	2126	N		CERAMICA	INFORME	0	0	0		1991 S
264	558	C	3	199	395	206	0	2131	SW		CALCARIA	BNA	0	0	0		1991 S
264	558	C	3	200	205	300	0	2122	W		CALCARIA	BP	0	0	0		1991 S
264	558	C	3	201	460	299	0	2126	NE		CALCARIA	BNA	0	0	0	FRAC	1991 S
264	558	C	3	202	468	441	0	2130	NW		GRANIT	BNA	0	0	0		1991 S
264	558	C	3	203	913	202	0	2170	W		CERAMICA	INFORME	0	0	0		1991 S
264	558	C	3	204	157	635	0	2159	P		RMI	BNA	0	0	0	FRAG	1991 S
264	558	C	3	205	725	407	0	2166	SW		RMI	BNA	0	0	0	FRAG	1991 S
264	558	C	3	206	668	411	0	2153	SW		QUARS	BPI	0	0	0		1991 S
264	558	C	3	207	857	733	0	2187	W		RMI	BNA	0	0	0	FRAG	1991 S
264	558	C	3	208	0	0	0	2200	SW		CERAMICA	INFORME	0	0	0	FRAG	1991 S
264	558	C	3	209	911	848	0	2227	P		CALCARIA	BNA	0	0	0	ALTERAT	1991 S
264	558	C	3	210	989	706	0	2225	NW		RMI	BNA	0	0	0	FRAG	1991 S
264	559	C		1	514	939	0	1261	P		SORRENCA	BNA	0	0	0	FRAG DE BNA	1991 S
264	559	C		2	676	932	0	1265	S		CERAMICA	INFORME	0	0	0		1991 S
264	559	C		3	991	562	0	1295	P		SORRENCA	BNA	0	0	0	FRAG	1991 S
264	559	C		4	718	230	0	1291	P		SORRENCA	BNA	0	0	0	FRAG	1991 S
264	559	C		5	458	937	0	1280	P		CERAMICA	INFORME	0	0	0		1991 S
264	559	C		7	206	917	0	1274	P		SORRENCA	BNA	0	0	0	FRAG	1991 S
264	559	C		8	30	977	0	1260	W		CERAMICA	INFORME	0	0	0		1991 S
264	559	C		9	677	380	0	1326	S		CERAMICA	INFORME	0	0	0		1991 S
264	559	C		10	799	624	0	1320	N		QUARS	BPF	0	0	0		1991 S
264	559	C		11	847	721	0	1316	P		INDET	BNA	0	0	0		1991 S
264	559	C		12	343	729	0	1303	P		ESQUIST	BNA	0	0	0	FRAG	1991 S
264	559	C		13	127	546	0	1316	P		ESQUIST	BNA	0	0	0	FRAG	1991 S



BOBILA MADURELL  
MAS DURAN  
Objectes Coordenats C5  
Campanya 1991

c	c	C	N												ALTERACIONS	P	D	
uX	uY	O	I	NUM.	X	Y	Zsup	Zinf	ORIENT	PENDENT	MATERIA	OBJECTE	LONG	AMPL	ESPE	OBSERVACIONS	ANY	U
a	a	N	V														I	
d	d	J															N	
																	B	
																	T	
																	U	
264	559	C		14	215	398	0	1294	SE		SORRENCA	BNA	0	0	0	FRAG	1991	S
264	559	C	2	15	526	506	0	1331	SE		CALCARIA	BN1G	0	0	0		1991	S
264	559	C	2	16	103	507	0	1337	SE		QUARS	BNA	0	0	0	FRAC	1991	S
264	559	C	2	17	297	612	0	1346	SE		SORRENCA	BNA	0	0	0	FRAG	1991	S
264	559	C	2	18	229	771	0	1330	P		QUARSITA	BNA	0	0	0	FRAC	1991	S
264	559	C	2	19	175	851	0	1326	P		QUARS	BNA	0	0	0	FRAC	1991	S
264	559	C	2	20	220	883	0	1319	P		QUARS	BPI	0	0	0		1991	S
264	559	C	2	21	93	925	0	1322	S		QUARS	BNA	0	0	0		1991	S
264	559	C	2	22	837	589	0	1326	S		SORRENCA	BNA	0	0	0	FRAG	1991	S
264	559	C	2	23	952	326	0	1330	P		QUARS	BNA	0	0	0	FRAC	1991	S
264	559	C	2	24	928	291	0	1331	SE		SORRENCA	BNA	0	0	0	FRAG	1991	S
264	559	C	2	25	7	458	0	1313	P		SORRENCA	BNA	0	0	0	FRAG	1991	S
264	559	C	2	26	519	242	0	1326	SE		SORRENCA	BNA	0	0	0	FRAG	1991	S
264	559	C	2	27	605	430	0	1335	P		SORRENCA	BNA	0	0	0	FRAG	1991	S
264	559	C	2	28	265	500	0	1360	P		SORRENCA	BNA	0	0	0	FRAG	1991	S
264	559	C	2	29	216	587	0	1361	SE		QUARS	BNA	0	0	0		1991	S
264	559	C	2	30	152	611	0	1346	S		SORRENCA	BNA	0	0	0	FRAG	1991	S
264	559	C	2	31	9	613	0	1342	S		CALCARIA	BNA	0	0	0	FRAC ALTERAT	1991	S
264	559	C	2	32	76	630	0	1350	P		CONGLOME	BNA	0	0	0	FRAC	1991	S
264	559	C	2	33	109	714	0	1354	P		SORRENCA	BNA	0	0	0	FRAG ALTERAT	1991	S
264	559	C	2	34	9	821	0	1356	W		SORRENCA	BNA	0	0	0	FRAG	1991	S
264	559	C	2	35	167	797	0	1360	P		SORRENCA	BNA	0	0	0	FRAG	1991	S
264	559	C	2	37	325	794	0	1363	W		QUARS	BNA	0	0	0	FRAC	1991	S
264	559	C	2	38	207	706	0	1352	P		CALCARIA	BNA	0	0	0	FRAG	1991	S
264	559	C	2	39	673	712	0	1338	P		QUARS	BNA	0	0	0	FRAC	1991	S
264	559	C	2	40	952	201	0	1385	SE		CONGLOME	BNA	0	0	0	FRAG	1991	S
264	559	C	2	41	656	377	0	1348	P		QUARSITA	BNA	0	0	0		1991	S
264	559	C	2	42	584	208	0	1363	V		SORRENCA	BNA	0	0	0		1991	S
264	559	C	2	43	377	79	0	1367	V		QUARS	BNA	0	0	0	FRAC	1991	S
264	559	C	2	44	206	636	0	1386	SW		GRANIT	BNA	0	0	0	FRAC	1991	S
264	559	C	2	45	174	665	0	1393	P		GRANIT	BNA	0	0	0	FRAG	1991	S
264	559	C	2	46	278	835	0	1369	P		RMI	BNA	0	0	0	FRAG	1991	S
264	559	C	2	47	310	742	0	1384	P		RMI	BNA	0	0	0		1991	S
264	559	C	2	48	379	638	0	1369	SE		RMI	BNA	0	0	0	FRAG	1991	S
264	559	C	2	49	182	839	0	1382	P		CERAMICA	INFORME	0	0	0		1991	S
264	559	C	2	50	123	823	0	1379	P		CERAMICA	INFORME	0	0	0		1991	S
264	559	C	2	51	174	760	0	1386	SE		RMI	BNA	0	0	0	FRAG	1991	S
264	559	C	2	52	336	146	0	1390	P		RMI	BNA	0	0	0	FRAG	1991	S
264	559	C	2	53	484	146	0	1369	SW		RMI	BNA	0	0	0	FRAG	1991	S
264	559	C	2	54	633	421	0	1364	P		CERAMICA	INFORME	0	0	0	4 FRAGS	1991	S
264	559	C	2	55	542	230	0	1392	SW		RMI	BNA	0	0	0	FRAG	1991	S
264	559	C	2	56	546	249	0	1409	SW		RMI	BNA	0	0	0	FRAG	1991	S
264	559	C	2	57	51	698	0	1386	S		QUARS	BPI	0	0	0		1991	S
264	559	C	2	58	794	41	0	1408	V		CALCARIA	BPF	0	0	0		1991	S
264	559	C	2	59	242	484	0	1386	P		CALCARIA	BPI	0	0	0		1991	S
264	559	C	2	60	530	138	0	1398	P		CONGLOME	BNA	0	0	0	FRAG	1991	S
264	559	C	2	61	751	617	0	1374	S		QUARS	BNA	0	0	0	FRAG	1991	S
264	559	C	2	62	918	173	0	1404	P		SORRENCA	BNA	0	0	0	FRAG	1991	S
264	559	C	2	63	335	857	0	1385	S		SORRENCA	BNA	0	0	0	FRAG	1991	S
264	559	C	2	64	175	827	0	1403	SW		QUARS	BNA	0	0	0	CODOL	1991	S

BOBILA MADURELL  
MAS DURAN  
Objectes Coordinats C5  
Campanya 1991

c	c	C	N										ALTERACIONS		P	D			
uX	uY	O	I	NUM.	X	Y	Zsup	Zinf	ORIENT	PENDENT	MATERIA	OBJECTE	LONG	AMPL	ESPE	OBSERVACIONS	ANY	U	I
a	a	N	V														N	B	
d	d	J																T	U
264	559	C	2		65	135	881	0	1397	NW	QUARS	BNA	0	0	0	FRAC	1991	S	
264	559	C	2		66	864	117	0	1388	S	SILEX	BP	0	0	0		1991	S	
264	559	C	2		67	934	79	0	1399	W	QUARS	BPI	0	0	0		1991	S	
264	559	C	2		68	961	196	0	1402	S	QUARS	BNA	0	0	0	FRAC 2 FRAGS	1991	S	
264	559	C	2		69	959	275	0	1399	SE	QUARS	BNA	0	0	0	FRAC	1991	S	
264	559	C	2		70	953	369	0	1402	V	QUARS	BNA	0	0	0		1991	S	
264	559	C	2		71	983	441	0	1364	V	SORRENCA	BPF	0	0	0		1991	S	
264	559	C	2		72	993	541	0	1403	V	CERAMICA	INFORME	0	0	0		1991	S	
264	559	C	2		73	842	598	0	1378	W	SORRENCA	BNA	0	0	0	FRAG	1991	S	
264	559	C	2		74	20	506	0	1397	V	SORRENCA	BNA	0	0	0	FRAG	1991	S	
264	559	C	2		75	948	840	0	1421	SE	SORRENCA	BNA	0	0	0	FRAG	1991	S	
264	559	C	2		76	35	671	0	1413	P	SORRENCA	BNA	0	0	0	FRAG	1991	S	
264	559	C	2		77	552	453	0	1397	V	CALCARIA	BPI	0	0	0		1991	S	
264	559	C	2		78	21	277	0	1408	N	CALCARIA	BNA	0	0	0		1991	S	
264	559	C	2		79	279	332	0	1423	W	CALCARIA	BNA	0	0	0	FRAC ALTERAT	1991	S	
264	559	C	2		80	211	557	0	1407	W	SORRENCA	FRAG	0	0	0	FRAG	1991	S	
264	559	C	2		81	47	932	0	1425	P	CONGLOME	BNA	0	0	0	FRAG	1991	S	
264	559	C	2		82	508	911	0	1440	SW	SORRENCA	BNA	0	0	0		1991	S	
264	559	C	2		83	210	629	0	1438	V	ESQUIST	BNA	0	0	0	FRAG	1991	S	
264	559	C	2		84	332	624	0	1442	P	CERAMICA	INFORME	0	0	0		1991	S	
264	559	C	2		85	276	551	0	1437	W	CALCARIA	BPI	0	0	0		1991	S	
264	559	C	2		86	381	442	0	1437	P	SORRENCA	BNA	0	0	0	FRAG ALTERAT	1991	S	
264	559	C	2		87	242	257	0	1440	N	RMI	BNE	0	0	0		1991	S	
264	559	C	2		88	642	131	0	1438	S	QUARSITA	BN1G	0	0	0		1991	S	
264	559	C	2		89	921	335	0	1432	P	CALCARIA	BPI	0	0	0		1991	S	
264	559	C	2		90	921	14	0	1430	P	SORRENCA	BNA	0	0	0	FRAG	1991	S	
264	559	C	2		91	766	74	0	1442	W	CALCARIA	BNA	0	0	0	ALTERAT	1991	S	
264	559	C	2		92	731	112	0	1452	W	RMI	BNA	0	0	0		1991	S	
264	559	C	2		93	687	126	0	1472	W	CONGLOME	BNA	0	0	0	MICROCONGL FRAG	1991	S	
264	559	C	2		94	536	41	0	1459	P	QUARS	BNA	0	0	0	FRAC	1991	S	
264	559	C	2		95	355	160	0	1454	V	QUARS	BN1G	0	0	0		1991	S	
264	559	C	2		96	279	156	0	1468	V	QUARS	BNA	0	0	0		1991	S	
264	559	C	2		97	498	295	0	1444	V	ESQUIST	BNA	0	0	0		1991	S	
264	559	C	2		98	748	231	0	1469	NW	SORRENCA	BNA	0	0	0		1991	S	
264	559	C	2		99	762	266	0	1461	S	CALCARIA	BNA	0	0	0		1991	S	
264	559	C	2		100	630	348	0	1472	W	INDET	BNA	0	0	0	FRAG	1991	S	
264	559	C	2		101	151	531	0	1449	NW	CALCARIA	BNA	0	0	0	FRAG	1991	S	
264	559	C	2		102	51	835	0	1439	S	INDET	BNA	0	0	0	FRAG	1991	S	
264	559	C	2		103	131	516	0	1439	S	CERAMICA	INFORME	0	0	0		1991	S	
264	559	C	2		104	317	735	0	1452	NE	ESQUIST	BNA	0	0	0	FRAG	1991	S	
264	559	C	2		105	182	833	0	1463	NE	RMI	BNA	0	0	0	FRAG	1991	S	
264	559	C	2		106	534	776	0	1440	W	CERAMICA	INFORME	0	0	0		1991	S	
264	559	C	2		107	23	445	0	1435	S	SORRENCA	BNA	0	0	0	FRAG	1991	S	
264	559	C	2		108	85	312	0	1475	NW	SORRENCA	BNA	0	0	0	FRAG	1991	S	
264	559	C	2		109	294	30	0	1468	W	SORRENCA	BNA	0	0	0	FRAG	1991	S	
264	559	C	2		110	226	247	0	1462	S	CERAMICA	INFORME	0	0	0		1991	S	
264	559	C	2		111	642	138	0	1485	NE	QUARS	BPI	0	0	0		1991	S	
264	559	C	2		112	754	244	0	1474	NW	CERAMICA	INFORME	0	0	0		1991	S	
264	559	C	2		113	768	29	0	1475	NE	CALCARIA	BNA	0	0	0	FRACTURAT	1991	S	
264	559	C	2		114	151	43	0	1470	S	ESQUIST	BNA	0	0	0	FRAG	1991	S	

BOBILA MADURELL  
MAS DURAN  
Objectes Coordinats C5  
Campanya 1991

c c C N													ALTERACIONS			P D		
uX	uY	O	I	NUM.	X	Y	Zsup	Zinf	ORIENT	PENDENT	MATERIA	OBJECTE	LONG	AMPL	ESPE	OBSERVACIONS	ANY	U I
a	a	N	V															N B
d	d	J															T U	
264	559	C	2	115	32	153	0	1464	S		RMI	BNA	0	0	0	FRAG	1991	S
264	559	C	2	116	43	262	0	1484	NW		RMI	BNA	0	0	0	FRAG	1991	S
264	559	C	2	117	950	108	0	1471	NE		SORRENCA	BNA	0	0	0	FRAG	1991	S
264	559	C	2	118	930	46	0	1476	V		QUARS	BPI	0	0	0		1991	S
264	559	C	2	119	751	172	0	1495	P		CALCARIA	BP	0	0	0		1991	S
264	559	C	2	120	689	125	0	1499	SW		CERAMICA	INFORME	0	0	0		1991	S
264	559	C	2	121	636	149	0	1504	NW		CERAMICA	INFORME	0	0	0		1991	S
264	559	C	2	122	461	143	0	1492	W		SORRENCA	BNA	0	0	0	FRAG	1991	S
264	559	C	2	123	309	104	0	1492	NW		SILEX	BPI	0	0	0		1991	S
264	559	C	2	124	657	455	0	1471	V		CERAMICA	INFORME	0	0	0		1991	S
264	559	C	2	125	146	556	0	1443	E		SORRENCA	BNA	0	0	0	FRAG	1991	S
264	559	C	2	126	773	749	0	1491	NW		SORRENCA	BNA	0	0	0		1991	S
264	559	C	2	127	559	51	0	1498	P		RMI	BNA	0	0	0	FRAG	1991	S
264	559	C	2	128	118	154	0	1491	NW		CONGLOME	BNA	0	0	0	MICROCONGLOME	1991	S
264	559	C	2	129	184	369	0	1480	NW		QUARS	BNA	0	0	0	FRAG	1991	S
264	559	C	2	130	222	425	0	1483	P		CONGLOME	BNA	0	0	0	MICROCONGL FRAG	1991	S
264	559	C	2	131	72	427	0	1496	NW		RMI	BNA	0	0	0	FRAG	1991	S
264	559	C	2	132	38	462	0	1489	N		SORRENCA	BNA	0	0	0	FRAG	1991	S
264	559	C	2	133	232	540	0	1462	P		QUARS	BPI	0	0	0		1991	S
264	559	C	2	134	155	618	0	1462	W		SORRENCA	BNA	0	0	0		1991	S
264	559	C	2	135	917	612	0	1442	S		CONGLOME	BNA	0	0	0	MICROCONGLOME	1991	S
264	559	C	2	136	744	38	0	1504	V		SORRENCA	BNA	0	0	0		1991	S
264	559	C	2	137	766	69	0	1501	V		CONGLOME	BNA	0	0	0		1991	S
264	559	C	2	138	701	240	0	1504	V		RMI	BP	0	0	0		1991	S
264	559	C	3	139	686	829	0	1520	W		RMI	BNA	0	0	0		1991	S
264	559	C	3	140	736	856	0	1521	P		CERAMICA	INFORME	0	0	0		1991	S
264	559	C	2	141	580	156	0	1503	P		RMI	BNA	0	0	0	FRAG	1991	S
264	559	C	2	142	482	218	0	1515	V		SORRENCA	BNA	0	0	0		1991	S
264	559	C	2	143	602	353	0	1505	S		SORRENCA	BNA	0	0	0	FRAG	1991	S
264	559	C	2	144	546	373	0	1500	S		SORRENCA	BNA	0	0	0		1991	S
264	559	C	2	145	483	424	0	1487	P		SORRENCA	BP	0	0	0	ALTERAT	1991	S
264	559	C	2	146	316	334	0	1480	S		CONGLOME	BNA	0	0	0	MICROCONGLOME	1991	S
264	559	C	2	147	237	210	0	1511	W		QUARS	BNA	0	0	0	FRAG	1991	S
264	559	C	2	148	253	306	0	1486	P		QUARS	BNA	0	0	0	FRAG	1991	S
264	559	C	2	149	334	390	0	1491	S		SORRENCA	BNA	0	0	0	FRAG	1991	S
264	559	C	2	150	282	406	0	1493	W		RMI	BNA	0	0	0	FRAG	1991	S
264	559	C	2	151	178	302	0	1507	S		SORRENCA	BNA	0	0	0	FRAG	1991	S
264	559	C	2	152	426	44	0	1497	V		QUARS	BN1G	0	0	0		1991	S
264	559	C	2	153	200	654	0	1500	NW		RMI	BNA	0	0	0	FRAG	1991	S
264	559	C	2	154	210	491	0	1516	S		QUARS	BNA	0	0	0		1991	S
264	559	C	2	155	234	490	0	1505			CERAMICA	INFORME	0	0	0		1991	S
264	559	C	2	156	293	424	0	1505	W		SORRENCA	BNA	0	0	0	FRAG	1991	S
264	559	C	2	157	361	407	0	1497	P		RMI	BNA	0	0	0	FRAG	1991	S
264	559	C	2	159	560	323	0	1536	V		CONGLOME	BNA	0	0	0	MICROCONGL FRAG	1991	S
264	559	C	2	160	591	344	0	1551	V		CALCARIA	BNA	0	0	0	FRAG	1991	S
264	559	C	2	161	804	265	1463	1517	P		ESQUIST	BNA	0	0	0	FRAG	1991	S
264	559	C	2	162	842	204	0	1515	P		CALCARIA	BNA	0	0	0		1991	S
264	559	C	2	163	611	55	0	1507	P		ESQUIST	BNA	0	0	0	FRAG	1991	S
264	559	C	2	164	490	84	0	1513	NW		SORRENCA	BNA	0	0	0	FRAG	1991	S
264	559	C	2	165	361	36	0	1513	P		QUARS	BP	0	0	0		1991	S

BOBILA MADURELL  
 MAS DURAN  
 Objectes Coordenats C5  
 Campanya 1991

		c	c	C	N													ALTERACIONS	P	D
uX	uY	O	I	NUM.	X	Y	Zsup	Zinf	ORIENT	PENDENT	MATERIA	OBJECTE	LONG	AMPL	ESPE	OBSERVACIONS	ANY	U	I	
a	a	N	V															N	B	
d	d	J																T	U	
264	559	C	2	166	114	53	0	1515	P	QUARS	BNA		0	0	0		1991	S		
264	559	C	2	167	392	286	0	1527	S	SORRENCA	BNA		0	0	0		1991	S		
264	559	C	2	168	366	259	0	1520	P	RMI	BNA		0	0	0		1991	S		
264	559	C	2	169	196	297	0	1522	P	QUARSITA	BNA		0	0	0		1991	S		
264	559	C	2	170	249	331	0	1523	S	QUARS	BNA		0	0	0	FRAG	1991	S		
264	559	C	2	171	202	350	0	1540	P	ESQUIST	BNA		0	0	0		1991	S		
264	559	C	2	172	141	332	0	1530		OS	INDET		0	0	0		1991	S		
264	559	C	2	173	557	165	0	1541	W	RMI	BNA		0	0	0	FRAG	1991	S		
264	559	C	2	174	371	95	0	1525	V	QUARS	BPI		0	0	0		1991	S		
264	559	C	2	175	351	237	0	1537	V	QUARS	BPI		0	0	0		1991	S		
264	559	C	2	176	164	168	0	1537	V	SORRENCA	BNA		0	0	0	FRAG	1991	S		
264	559	C	2	177	262	863	0	1503	P	QUARS	BNA		0	0	0	FRAC	1991	S		
264	559	C	2	178	838	103	0	1411	NE	RMI	BN1G		0	0	0		1991	S		
264	559	C	2	179	2	671	0	1425	S	CALCARIA	BNA		0	0	0		1991	S		
264	559	C	2	180	538	444	0	1433	W	ESQUIST	BNA		0	0	0	FRAG	1991	S		
264	559	C	2	181	173	828	0	1427	N	ESQUIST	BNA		0	0	0	FRAG	1991	S		
264	559	C	2	182	494	534	0	1432	NE	QUARS	BNA		0	0	0	FRAG	1991	S		
264	559	C	2	183	135	892	0	1417	N	QUARS	BNA		0	0	0	FRAG	1991	S		
264	559	C	2	184	15	506	0	1433	NW	CERAMICA	INFORME		0	0	0		1991	S		
264	559	C	2	185	970	514	0	1433	W	CERAMICA	INFORME		0	0	0	2 FRAGS	1991	S		
264	559	C	2	186	927	347	0	1432	P	CERAMICA	INFORME		0	0	0		1991	S		
264	559	C	2	187	30	559	0	1399	W	QUARSITA	BNA		0	0	0	FRAG	1991	S		
264	559	C	2	188	748	598	0	1412	V	CALCARIA	BPF		0	0	0		1991	S		
264	559	C	2	189	513	117	0	1376	P	QUARSITA	BNA		0	0	0	FRAG	1991	S		
264	559	C	2	190	940	173	0	1397	P	QUARS	BNA		0	0	0	FRAC	1991	S		
264	559	C	2	191	836	572	0	1421	P	QUARS	BPI		0	0	0		1991	S		
264	559	C	2	192	965	417	0	1431	SE	CERAMICA	INFORME		0	0	0		1991	S		
264	559	C	2	193	939	257	0	1396	P	CERAMICA	INFORME		0	0	0	ARGILA CUITA	1991	S		
264	559	C	2	194	888	47	0	1555	P	QUARS	BPI		0	0	0		1991	S		
264	559	C	2	195	837	76	0	1554	E	ESQUIST	BNA		0	0	0	FRAG	1991	S		
264	559	C	2	196	561	21	0	1576	N	QUARS	BNA		0	0	0		1991	S		
264	559	C	2	197	360	309	0	1563	P	SORRENCA	BNA		0	0	0	FRAG	1991	S		
264	559	C	2	198	61	195	0	1558	W	QUARS	BPI		0	0	0		1991	S		
264	559	C	2	199	81	96	0	1533	P	SORRENCA	BNA		0	0	0	FRAG	1991	S		
264	559	C	2	200	81	27	0	1550	NE	RMI	BNA		0	0	0	FRAG	1991	S		
264	559	C	2	201	767	146	0	1580	P	QUARSITA	BNA		0	0	0		1991	S		
264	559	C	2	202	945	345	0	1558	P	QUARS	BPF		0	0	0		1991	S		
264	559	C	2	203	946	186	0	1563	NE	SORRENCA	BNA		0	0	0		1991	S		
264	559	C	2	204	831	34	0	1570	P	CERAMICA	INFORME		0	0	0	3 FRAGS	1991	S		
264	559	C	2	205	649	123	1566	1591	NW	RMI	BNA		0	0	0	FRAG	1991	S		
264	559	C	2	206	705	256	0	1610	W	RMI	BNA		0	0	0	FRAG	1991	S		
264	559	C	2	208	305	41	0	1602	E	QUARSITA	BNA		0	0	0	FRAC	1991	S		
264	559	C	2	209	100	714	0	1528	SE	ESQUIST	BNA		0	0	0		1991	S		
264	559	C	2	211	164	856	0	1502	SE	RMI	BNA		0	0	0	FRAG	1991	S		
264	559	C	2	212	962	199	0	1595	NE	CONGLOME	BNA		0	0	0	FRAG	1991	S		
264	559	C	2	213	402	946	0	1504	SE	QUARSITA	BNA		0	0	0	FRAG	1991	S		
264	559	C	3	214	902	584	0	1502	P	CERAMICA	INFORME		0	0	0	FRAG	1991			
264	559	C	3	215	999	846	0	1543	P	CERAMICA	APLICA		0	0	0	MOGRO	1991			
264	559	C	3	216	830	833	0	1592	SE	CERAMICA	INFORME		0	0	0	VARIS FRAGS	1991			
264	559	C	3	217	919	668	0	1609	V	CERAMICA	APLICA		0	0	0	MAMELO FRAG	1991			

97

BOBILA MADURELL  
MAS DURAN  
Objectes Coordenats C5  
Campanya 1991

c	c	C	N										ALTERACIONS		P	D			
uX	uY	O	I	NUM.	X	Y	Zsup	Zinf	ORIENT	PENDENT	MATERIA	OBJECTE	LONG	AMPL	ESPE	OBSERVACIONS	ANY	U	I
a	a	N	V															N	B
d	d	J																T	U
264	559	C	3		218	156	734	0	1576	P	QUARS	BN1G	0	0	0		1991		
264	559	C	3		219	165	641	0	1587	V	RMI	BNA	0	0	0	FRAG	1991		
264	559	C	3		220	153	565	0	1591	S	QUARS	BNA	0	0	0	FRAG	1991		
264	559	C	3		221	104	563	0	1575	N	RMI	BNA	0	0	0		1991	S	
264	559	C	3		222	102	502	0	1585	P	INDET	BNA	0	0	0		1991	S	
264	559	C	3		223	274	410	0	1614	V	ESQUIST	BNA	0	0	0	FRAG	1991	S	
264	559	C	3		224	127	258	0	1625	SE	QUARS	BPF	0	0	0	2 FRAGS	1991	S	
264	559	C	3		225	244	335	0	1631	W	CONGLOME	BNA	0	0	0	FRAG MICROCONGL	1991	S	
264	559	C	3		226	312	276	0	1624	NW	CERAMICA	INFORME	0	0	0	2 FRAGS	1991	S	
264	559	C	3		227	688	114	0	1606	SW	ESQUIST	BNA	0	0	0	FRAG	1991	S	
264	559	C	3		228	888	125	0	1653	S	CERAMICA	INFORME	0	0	0	FRAG	1991	S	
264	559	C	3		229	763	341	0	1630	P	QUARSITA	BPF	0	0	0		1991	S	
264	559	C	3		230	837	626	0	1641	P	SILEX	BP	0	0	0		1991	S	
264	559	C	3		231	550	936	1475	1644	P	CALCARIA	BNA	0	0	0	ALTERAT	1991	S	
264	559	C	3		232	822	430	1435	1631	V	RMI	BNA	0	0	0	FRAG	1991	S	
264	559	C	3		233	923	47	0	1704	E	OS	DET	0	0	0	HOM	1991	S	
264	559	C	3		234	966	962	0	1730	W	CERAMICA	INFORME	0	0	0	2 FRAGS	1991	S	
264	559	C	3		235	807	67	0	1830	V	CERAMICA	INFORME	0	0	0		1991	S	
264	559	C	3		236	841	151	0	1805	P	TOVOT	FRAG	0	0	0		1991	S	
264	559	C	3		237	54	400	0	1785	W	CALCARIA	BNA	0	0	0		1991	S	
264	559	C			238	683	538	0	1869	P	SILEX	BP2G	0	0	0		1991	S	
264	559	C			239	941	767	0	2060	V	RMI	BNA	0	0	0	FRAG	1991	S	
264	559	C			240	889	938	0	2041		CONGLOME	BNA	0	0	0		1991	S	
264	559	C	3		241	755	10	0	2083	S	CERAMICA	VORA	0	0	0		1991	S	
264	559	C	3		242	956	48	0	2127	S	CALCARIA	BNA	0	0	0	FRAC 'BN1G?	1991	S	
264	559	C	3		243	978	129	0	2120	V	RMI	BNA	0	0	0	FRAG	1991	S	
264	559	C	3		244	959	162	0	2136	SE	CONGLOME	BNA	0	0	0	FRAG	1991	S	
264	560	C			1	404	72	0	1186	S	SORRENCA	BNA	0	0	0	FRAG BNE?	1991	S	
264	560	C			2	228	230	0	1172	P	QUARS	BNA	0	0	0	FRAC	1991	S	
264	560	C			3	332	310	0	1165	P	CERAMICA	INFORME	0	0	0	VARIS FRAGS	1991	S	
264	560	C			4	397	9	0	1236	W	SORRENCA	BNA	0	0	0	FRAG	1991	S	
264	560	C			5	312	13	0	1274	SW	CALCARIA	FRAG	0	0	0	NO RECUPERAT	1991	S	
264	560	C			6	41	562	0	1194	V	CERAMICA	INFORME	0	0	0		1991	S	
264	560	C			7	181	527	0	1176	V	SORRENCA	BNA	0	0	0	FRAG	1991	S	
264	560	C			8	207	527	0	1154	P	CALCARIA	BNA	0	0	0	FRAG	1991	S	
264	560	C			9	633	221	0	1230	P	CERAMICA	INFORME	0	0	0		1991	S	
264	560	C			10	345	64	0	1240	P	SORRENCA	BNA	0	0	0	FRAG	1991	S	
264	560	C			11	425	120	0	1223	E	SORRENCA	BNA	0	0	0	FRAG	1991	S	
264	560	C	2		12	892	50	0	1320	NE	SORRENCA	BNA	0	0	0	FRAG	1991	S	
264	560	C	2		13	793	42	0	1315	NE	CERAMICA	INFORME	0	0	0		1991	S	
264	560	C	2		14	542	171	0	1298	N	CALCARIA	BNA	0	0	0	FRAG	1991	S	
264	560	C	2		15	522	236	0	1266	N	QUARS	BNA	0	0	0	FRAG	1991	S	
264	560	C	2		16	452	138	0	1230	NW	CERAMICA	INFORME	0	0	0	2 FRAGS	1991	S	
264	560	C	2		17	353	114	0	1264	NE	QUARS	BNA	0	0	0		1991	S	
264	560	C	2		18	294	149	0	1270	NE	SORRENCA	BNA	0	0	0		1991	S	
264	560	C	2		19	203	298	0	1264	W	SORRENCA	BNA	0	0	0	FRAG	1991	S	
264	560	C	2		20	231	258	0	1272	NE	CERAMICA	INFORME	0	0	0		1991	S	
264	560	C	2		21	109	294	0	1267	NE	ESQUIST	BNA	0	0	0		1991	S	
264	560	C	2		22	202	26	0	1298	N	ESQUIST	BNA	0	0	0	FRAG	1991	S	
264	560	C	2		23	147	74	0	1299	P	QUARS	BPF	0	0	0		1991	S	

BOBILA MADURELL  
MAS DURAN  
Objectes Coordinats C5  
Campanya 1991

c	c	C	N	NUM.	X	Y	Zsup	Zinf	ORIENT	PENDENT	MATERIA	OBJECTE	LONG	AMPL	ESPE	OBSERVACIONS	P	D
uX	uY	O	I														ANY	U
a	a	N	V														N	B
d	d	J															T	U
264	560	C	2	24	45	236	0	1250	N		CALCARIA	BPF	0	0	0		1991	S
264	560	C	2	25	920	150	0	1374	N		CERAMICA	INFORME	0	0	0		1991	S
264	560	C	2	26	312	636	0	1369	N		RMI	BNA	0	0	0	FRAG	1991	S
264	560	C	2	27	873	235	0	1452	SE		RMI	BNA	0	0	0	FRAG	1991	S
264	560	C	2	28	757	137	0	1453	S		CERAMICA	INFORME	0	0	0		1991	S
264	560	C	2	29	935	10	0	1460	S		QUARSITA	BNA	0	0	0	FRAG	1991	S
264	560	C	2	30	980	5	0	1458	P		ESQUIST	BNA	0	0	0	FRAG	1991	S
264	560	C	2	31	989	40	0	1459	P		QUARS	BNA	0	0	0		1991	S
264	560	C	3	32	640	75	0	1512	P		ESQUIST	BNA	0	0	0	FRAG	1991	S
264	560	C	3	33	302	644	0	1483	S		SORRENCA	BNA	0	0	0		1991	S
264	560	C	3	34	403	411	0	1484	E		SORRENCA	BNA	0	0	0	FRAG	1991	S
264	560	C	3	35	380	352	0	1487	V		CERAMICA	INFORME	0	0	0	2 FRAGS	1991	S
264	560	C	3	36	531	370	0	1510	V		CERAMICA	INFORME	0	0	0		1991	S
264	560	C	3	37	392	18	0	1545	P		CERAMICA	INFORME	0	0	0		1991	S
265	554	C		1	804	916	1412	1426	NW		CERAMICA	VORA	0	0	0	2 FRAGS PANXA	1991	S
265	554	C		2	733	662	0	1420	S		CERAMICA	INFORME	0	0	0		1991	S
265	554	C		3	800	975	0	1344	N		CALCARIA	BNA	0	0	0		1991	S
265	554	C		4	118	855	0	1342	P		CERAMICA	INFORME	0	0	0		1991	S
265	554	C		5	139	963	0	1400	NW-SE	V	CERAMICA	INFORME	0	0	0		1991	S
265	554	C		6	178	917	0	1405			OS	INDET	0	0	0		1991	S
265	554	C		7	64	778	0	1395	N-S	W	RMI	BNA	0	0	0	FRAG	1991	S
265	554	C		8	147	766	0	1400	NE-SW	V	CERAMICA	VORA	0	0	0		1991	S
265	554	C		9	277	642	0	1418	W		QUARS	BNA	0	0	0	FRAG	1991	S
265	554	C		10	173	733	0	1405	N		RMI	BNA	0	0	0	FRAG	1991	S
265	554	C		11	19	973	0	1432	P		QUARS	BNA	0	0	0	FRAG	1991	S
265	554	C		12	180	972	0	1450	P		RMI	BNA	0	0	0	FRAG	1991	S
265	554	C		13	690	957	0	1450	NE		QUARS	BNA	0	0	0		1991	S
265	554	C		14	109	845	0	1445	P		RMI	BNA	0	0	0		1991	S
265	554	C		15	233	878	0	1507	NW		QUARS	BNA	0	0	0	FRAG	1991	S
265	554	C		16	168	888	0	1485	P		RMI	BNA	0	0	0		1991	S
265	554	C		17	142	918	0	1515	P		RMI	BNA	0	0	0		1991	S
265	554	C		18	83	888	0	1490	SE		QUARS	BNA	0	0	0		1991	S
265	554	C		19	504	752	0	1537	NE		RMI	BNA	0	0	0	FRAG	1991	S
265	554	C		20	353	581	0	1534			CALCARIA	BNA	0	0	0	FRAG	1991	S
265	554	C		21	327	966	0	1605			CERAMICA	VORA	0	0	0	LLENGUETA	1991	S
265	554	C		22	523	957	0	1615			QUARS	BNA	0	0	0	FRAG	1991	S
265	554	C		23	626	956	0	1700	NE		RMI	BNA	0	0	0	FRAG	1991	S
265	554	C		24	625	898	0	1705	E		PISSARRA	BNA	0	0	0	FRAG	1991	S
265	554	C		25	568	794	0	1685	P		RMI	BNA	0	0	0	FRAG	1991	S
265	554	C		26	753	700	0	1693	P		INDET	BNA	0	0	0	NO RECUPERAT	1991	S
265	554	C		27	812	835	0	1774	P		OS	DET	0	0	0		1991	S
265	554	C		28	984	914	0	1756	W		QUARS	BNA	0	0	0	FRAG	1991	S
265	554	C		29	841	901	0	1788	W		INDET	BNA	0	0	0	FRAG	1991	S
265	554	C		30	752	871	0	1782	N		INDET	BNA	0	0	0	FRAG	1991	S
265	554	C		31	755	969	0	1810	N		RMI	BNA	0	0	0	FRAG	1991	S
265	554	C		32	661	864	0	1813	NE		RMI	BNA	0	0	0	FRAG	1991	S
265	554	C		34	743	793	0	1810	SW		RMI	BNA	0	0	0	FRAG	1991	S
265	554	C		35	61	821	1794	1855	N		RMI	BNA	0	0	0	FRAG	1991	S
265	554	C		36	168	831	0	1861	N		RMI	BNA	0	0	0	FRAG ALTERAT	1991	S
265	554	C		37	199	894	0	1845	W		QUARS	BNA	0	0	0	FRAG	1991	S

BOBILA MADURELL  
MAS DURAN  
Objectes Coordenats C5  
Campanya 1991

c	c	C	N										ALTERACIONS			P	D		
uX	uY	O	I	NUM.	X	Y	Zsup	Zinf	ORIENT	PENDENT	MATERIA	OBJECTE	LONG	AMPL	ESPE	OBSERVACIONS	ANY	U	I
a	a	N	V															N	B
d	d	J																T	U
265	554	C		38	539	950	0	1867	P		CONGLOME	BNA	0	0	0	FRAG MICROCONGL	1991	S	
265	554	C		39	252	854	0	1855	P		RMI	BNA	0	0	0	FRAG	1991	S	
265	554	C		40	74	896	0	1877	NW		CERAMICA	INFORME	0	0	0		1991	S	
265	554	C		41	356	946	0	1937	P		QUARS	BNA	0	0	0	FRAG	1991	S	
265	554	C		42	438	913	0	1946	S		RMI	BNA	0	0	0	FRAG	1991	S	
265	554	C	3	43	688	948	0	1929	N		CONGLOME	BNA	0	0	0		1991	S	
265	555	C		1	826	714	0	1315	P		SILEX	BP2G	0	0	0		1991	S	
265	555	C		3	578	379	0	1399	P		CERAMICA	INFORME	0	0	0		1991	S	
265	555	C		4	619	251	0	1399			QUARSITA	BPI	0	0	0		1991	S	
265	555	C		5	837	77	0	1350	N-S	P	CERAMICA	INFORME	0	0	0		1991	S	
265	555	C		6	739	76	0	1369	NW-SE	P	CERAMICA	INFORME	0	0	0		1991	S	
265	555	C		7	555	25	0	1375	N-S	P	CERAMICA	INFORME	0	0	0		1991	S	
265	555	C		8	404	12	0	1399	V		RMI	BNA	0	0	0	FRAG	1991	S	
265	555	C		9	410	220	0	1434	NE-SW	P	RMI	BNA	0	0	0	FRAG	1991	S	
265	555	C		10	488	29	0	1404	E-W	P	CERAMICA	VORA	0	0	0		1991	S	
265	555	C		11	512	28	0	1397	E-W	P	CERAMICA	INFORME	0	0	0		1991	S	
265	555	C		12	617	94	0	1395	N-S	P	CERAMICA	INFORME	0	0	0		1991	S	
265	555	C		13	603	236	0	1415	N-S	P	CERAMICA	PANXA	0	0	0		1991	S	
265	555	C		14	666	24	0	1372			CERAMICA	INFORME	0	0	0		1991	S	
265	555	C		15	810	33	0	1350	N-S	P	CERAMICA	INFORME	0	0	0		1991	S	
265	555	C		16	738	191	0	1384	NW-SE	P	CERAMICA	INFORME	0	0	0		1991	S	
265	555	C		17	884	351	0	1405	NW-SE	P	CERAMICA	VORA	0	0	0		1991	S	
265	555	C		18	906	323	0	1392	N-S	P	CERAMICA	INFORME	0	0	0		1991	S	
265	555	C		19	922	285	0	1394	N-S	P	CERAMICA	INFORME	0	0	0		1991	S	
265	555	C		20	931	351	0	1401	N-S	P	CERAMICA	VORA	0	0	0		1991	S	
265	555	C		21	734	213	0	1419	N-S	W	CERAMICA	PANXA	0	0	0		1991	S	
265	555	C		22	692	170	0	1400			CERAMICA	INFORME	0	0	0		1991	S	
265	555	C		23	692	149	0	1394			QUARS	BNA	0	0	0		1991	S	
265	555	C		24	723	114	0	1380	NW-SE	NE	CERAMICA	INFORME	0	0	0		1991	S	
265	555	C		25	805	175	0	1375	E-W	P	QUARS	BNA	0	0	0		1991	S	
265	555	C		26	904	130	0	1380	NE-SW	P	CERAMICA	INFORME	0	0	0		1991	S	
265	555	C		27	257	801	0	1380	NE-SW	N	CERAMICA	INFORME	0	0	0		1991	S	
265	555	C		28	873	211	0	1690	NE-SW	P	CERAMICA	INFORME	0	0	0		1991	S	
265	555	C		29	880	269	0	1390	N-S	P	CERAMICA	INFORME	0	0	0		1991	S	
265	555	C		30	866	317	0	1390	NE-SW	E	CERAMICA	INFORME	0	0	0		1991	S	
265	555	C		31	30	762	0	1409	NW-SE	P	CERAMICA	INFORME	0	0	0		1991	S	
265	555	C		32	803	422	0	1432	NW-SE	P	RMI	BNA	0	0	0	FRAG	1991	S	
265	555	C		33	941	69	0	1375	N		CERAMICA	VORA	0	0	0	APLICA MUGRO	1991	S	
265	555	C		34	938	137	0	1375	N		CERAMICA	INFORME	0	0	0		1991	S	
265	555	C		35	850	37	0	1415	SW		CALCARIA	BN1G	0	0	0		1991	S	
265	555	C		36	867	154	0	1410	S		RMI	BNA	0	0	0	FRAG	1991	S	
265	555	C		37	871	166	0	1395	P		CERAMICA	INFORME	0	0	0		1991	S	
265	555	C		38	830	131	0	1411	W		QUARS	BNA	0	0	0	FRAG	1991	S	
265	555	C		39	871	166	0	1425	W		CALCARIA	BNA	0	0	0		1991	S	
265	555	C		40	688	127	0	1411	P		CERAMICA	INFORME	0	0	0		1991	S	
265	555	C		41	670	90	0	1417	P		RMI	BNA	0	0	0	FRAG	1991	S	
265	555	C		42	757	285	0	1435	P		INDET	BNA	0	0	0	FRAG	1991	S	
265	555	C		43	823	197	0	1422	P		RMI	BNA	0	0	0	FRAG	1991	S	
265	555	C		44	900	202	0	1414	P		QUARS	BNA	0	0	0	FRAG	1991	S	
265	555	C		45	542	129	0	1435	P		CERAMICA	INFORME	0	0	0		1991	S	

BOBILA MADURELL  
MAS DURAN  
Objectes Coordenats C5  
Campanya 1991

													ALTERACIONS		P D				
c	c	C	N												ANY	U	I		
uX	uY	O	I	NUM.	X	Y	Zsup	Zinf	ORIENT	PENDENT	MATERIA	OBJECTE	LONG	AMPL	ESPE	OBSERVACIONS	ANY	U	I
a	a	N	V												N	B			
d	d	J													T	U			
265	555	C		46	449	86	0	1451	P		QUARS	BNA	0	0	0	FRAG	1991	S	
265	555	C		47	186	25	0	1425	NW		CERAMICA	INFORME	0	0	0		1991	S	
265	555	C		48	102	67	0	1437	W		CERAMICA	INFORME	0	0	0		1991	S	
265	555	C		49	106	155	0	1450			OS	DET	0	0	0		1991	S	
265	555	C		50	265	244	1410	1460	N		RMI	BNA	0	0	0	FRAG	1991	S	
265	555	C		51	435	165	0	1460	P		QUARSITA	BNA	0	0	0		1991	S	
265	555	C		52	476	163	0	1450	SW		CERAMICA	INFORME	0	0	0		1991	S	
265	555	C		53	814	99	0	1440	SE		QUARS	BNA	0	0	0	FRAG	1991	S	
265	555	C		54	980	206	0	1475	P		QUARS	BNA	0	0	0	FRAG	1991	S	
265	555	C		55	83	175	0	1460	P		OS	DET	0	0	0		1991	S	
265	555	C		56	9	119	0	1450	P		SILEX	BP2G	0	0	0		1991	S	
265	555	C		57	148	120	0	1465	E		CERAMICA	INFORME	0	0	0		1991	S	
265	555	C	2	58	490	408	0	1460	N		CERAMICA	INFORME	0	0	0		1991	S	
265	555	C	2	59	935	732	0	1475	V		RMI	BNA	0	0	0	FRAG	1991	S	
265	555	C	2	60	912	895	0	1460	P		RMI	BNA	0	0	0	FRAG	1991	S	
265	555	C	2	61	839	506	0	1480	N		CALCARIA	BNA	0	0	0		1991	S	
265	555	C	3	62	84	67	0	1477	N		RMI	BNA	0	0	0	FRAG	1991	S	
265	555	C	2	63	238	278	0	1495	NW		CONGLOME	BNA	0	0	0	FRAG	1991	S	
265	555	C	2	64	644	586	0	1490	P		RMI	BNA	0	0	0		1991	S	
265	555	C	2	65	846	328	0	1495	N		CERAMICA	INFORME	0	0	0		1991	S	
265	555	C	2	66	261	189	0	1500	S		QUARS	BNA	0	0	0	2 FRAGS	1991	S	
265	555	C	2	67	152	216	0	1485	NW		RMI	BNA	0	0	0		1991	S	
265	555	C	2	68	419	319	0	1505	V		QUARS	BNA	0	0	0	FRAG	1991	S	
265	555	C	2	69	452	370	0	1520	V		QUARS	BNA	0	0	0	FRAG	1991	S	
265	555	C	2	70	759	939	1370	1505			CALCARIA	BNA	0	0	0	FRAG	1991	S	
265	555	C	2	71	39	227	0	1488			OS	DET	0	0	0		1991	S	
265	555	C	2	72	517	210	0	1511	P		QUARS	BNA	0	0	0		1991	S	
265	555	C	2	73	353	385	0	1527	P		QUARS	BNA	0	0	0	FRAG	1991	S	
265	555	C	2	74	277	436	0	1509	P		QUARS	BPI	0	0	0		1991	S	
265	555	C	2	76	937	980	0	1505	N		ESQUIST	BNA	0	0	0	FRAG	1991	S	
265	555	C	2	77	929	536	0	1542	N		QUARS	BNA	0	0	0	FRAG	1991	S	
265	555	C	2	78	242	255	0	1520	N		RMI	BNA	0	0	0	FRAG	1991	S	
265	555	C	3	79	174	60	0	1519	P		CALCARIA	BP	0	0	0		1991	S	
265	555	C	2	80	644	875	0	1566	N		RMI	BNA	0	0	0	FRAG	1991	S	
265	555	C	3	81	864	55	0	1555	SE		RMI	BNA	0	0	0	FRAG	1991	S	
265	555	C	3	82	929	105	0	1562	E		RMI	BNE	0	0	0	BNE?	1991	S	
265	555	C	2	83	277	528	0	1555	N		RMI	BNA	0	0	0	FRAG	1991	S	
265	555	C	2	84	750	404	0	1515	W		RMI	BNA	0	0	0	FRAG	1991	S	
265	555	C	2	85	316	968	0	1516			CONGLOME	BNA	0	0	0	MICROCONGLOME	1991	S	
265	555	C	2	86	750	408	0	1560	V		QUARS	BNA	0	0	0	FRAG	1991	S	
265	555	C	2	87	850	237	0	1605	N		SORRENCA	BNA	0	0	0		1991	S	
265	555	C	2	88	750	408	0	1570			CERAMICA	INFORME	0	0	0		1991	S	
265	555	C	2	89	432	223	0	1575	E		CERAMICA	INFORME	0	0	0		1991	S	
265	555	C	2	90	59	254	0	1556	W		RMI	BNA	0	0	0	FRAG	1991	S	
265	555	C	2	91	170	328	0	1580	N		QUARS	BNA	0	0	0		1991	S	
265	555	C	2	92	40	413	0	1570	N		QUARS	BNA	0	0	0		1991	S	
265	555	C	2	93	107	434	0	1600	NW		SORRENCA	BNA	0	0	0		1991	S	
265	555	C	2	94	229	393	0	1615	W		RMI	BNA	0	0	0	FRAG	1991	S	
265	555	C	2	95	447	364	1500	1657	V		SORRENCA	BNA	0	0	0	FRAG	1991	S	
265	555	C	2	96	740	530	0	1580	P		QUARS	BNA	0	0	0	FRAG	1991	S	



BOBILA MADURELL  
MAS DURAN  
Objectes Coordenats C5  
Campanya 1991

c	c	C	N	NUM.	X	Y	Zsup	Zinf	ORIENT	PENDENT	MATERIA	OBJECTE	LONG	AMPL	ESPE	ALTERACIONS OBSERVACIONS	P D ANY U I N B T U
uX	uY	O	I														
a	a	N	V														
d	d	J															
265	555	C	2	97	37	580	1610	1580	P		RMI	BNA	0	0	0	FRAG	1991 S
265	555	C	2	98	387	639	1510	1605	V		SORRENCA	BNA	0	0	0	FRAG	1991 S
265	555	C	2	99	373	847	0	1580	V		RMI	BNA	0	0	0	FRAG	1991 S
265	555	C	2	100	612	878	0	1577	S		RMI	BNA	0	0	0	FRAG	1991 S
265	555	C	2	101	667	977	0	1565	S		RMI	BNA	0	0	0	FRAG	1991 S
265	555	C	2	102	72	641	0	1594			QUARS	BNA	0	0	0		1991 S
265	555	C	2	103	125	534	0	1590	V		CERAMICA	INFORME	0	0	0		1991 S
265	555	C	2	104	156	993	0	1530	NE		QUARS	BNA	0	0	0	FRAG	1991 S
265	555	C	2	105	391	589	0	1584	V		RMI	BNA	0	0	0	FRAG	1991 S
265	555	C	2	106	104	299	0	1605	P		CERAMICA	INFORME	0	0	0		1991 S
265	555	C	2	107	32	386	0	1619	V		CERAMICA	INFORME	0	0	0		1991 S
265	555	C	3	108	691	141	0	1625	W		CALCARIA	BNA	0	0	0	FRAG	1991 S
265	555	C	3	109	723	196	0	1636	W		CALCARIA	BNA	0	0	0	ALTERAT	1991 S
265	555	C	2	110	638	422	0	1628			OS	INDET	0	0	0		1991 S
265	555	C	2	111	21	502	0	1610	N		CERAMICA	INFORME	0	0	0	VARIS FRAGS	1991 S
265	555	C	2	112	73	470	0	1613	SW		QUARS	BNA	0	0	0	FRAG	1991 S
265	555	C	2	113	107	667	0	1630	E		ESQUIST	BNA	0	0	0	FRAG	1991 S
265	555	C	2	114	146	755	0	1623	NW		RMI	BNA	0	0	0	FRAG	1991 S
265	555	C	2	115	39	775	0	1630	V		QUARSITA	BPI	0	0	0		1991 S
265	555	C	2	116	70	859	0	1625			OS	INDET	0	0	0		1991 S
265	555	C	2	117	773	219	0	1642			SILEX	BP2G	0	0	0		1991 S
265	555	C	2	118	766	411	0	1660			ORGANIC	CARBO	0	0	0		1991 S
265	555	C	2	119	247	830	0	1660			ORGANIC	CARBO	0	0	0		1991 S
265	555	C	3	120	543	12	0	1630	P		RMI	BNA	0	0	0	FRAG	1991 S
265	555	C	3	121	207	211	0	1650	S		QUARS	BNA	0	0	0		1991 S
265	555	C	2	122	159	479	0	1643	P		QUARS	CODOL	0	0	0	NO RECUPERAT	1991 S
265	555	C	2	123	186	455	0	1643	E		CALCARIA	BNA	0	0	0		1991 S
265	555	C	2	124	226	478	0	1645	SE		CALCARIA	BNA	0	0	0		1991 S
265	555	C	2	125	267	473	0	1632	N		RMI	BNA	0	0	0	FRAG ALTERAT	1991 S
265	555	C	2	126	292	401	0	1648	P		CERAMICA	INFORME	0	0	0	POSSIBLE MJGRO	1991 S
265	555	C	2	127	132	849	0	1650	W		CERAMICA	INFORME	0	0	0		1991 S
265	555	C	2	128	442	727	0	1667	S		QUARS	BNA	0	0	0	FRAG	1991 S
265	555	C	2	129	48	675	0	1658	P		SILEX	BPI	0	0	0		1991 S
265	555	C	3	130	47	140	0	1684	S		CALCARIA	BNA	0	0	0	FRAC	1991 S
265	555	C	3	131	100	153	0	1682	N		CALCARIA	BNA	0	0	0	FRAG ALTERAT	1991 S
265	555	C	2	132	154	350	0	1675	SE		INDET	BNA	0	0	0	FRAG	1991 S
265	555	C	2	133	441	255	0	1698	NW		SORRENCA	BNA	0	0	0		1991 S
265	555	C	2	134	557	260	0	1670	P		SORRENCA	BNA	0	0	0	FRAG	1991 S
265	555	C	2	135	606	314	1620	1675	P		CALCARIA	BNA	0	0	0	FRAC	1991 S
265	555	C	2	136	578	400	1623	1685	N		RMI	BNA	0	0	0	FRAG	1991 S
265	555	C	2	137	852	469	0	1661	S		CERAMICA	VORA	0	0	0		1991 S
265	555	C	2	138	125	954	0	1680	S		QUARS	BNA	0	0	0	FRAG	1991 S
265	555	C	3	139	234	50	0	1685	W		RMI	BNA	0	0	0	FRAG	1991 S
265	555	C	2	140	138	293	0	1705	W		RMI	BNA	0	0	0	FRAG	1991 S
265	555	C	2	141	359	318	0	1711	P		QUARS	BNA	0	0	0	FRAG	1991 S
265	555	C	3	142	690	92	0	1685	SW		ESQUIST	BNA	0	0	0	FRAG	1991 S
265	555	C	2	143	63	775	0	1696			OS	INDET	0	0	0		1991 S
265	555	C	2	144	130	583	0	1696			CERAMICA	INFORME	0	0	0		1991 S
265	555	C	3	145	621	33	0	1695	SW		CERAMICA	VORA	0	0	0	2 LLENGUETES	1991 S
265	555	C	2	146	39	343	0	1612	W		RMI	BNA	0	0	0		1991 S

BOBILA MADURELL  
MAS DURAN  
Objectes Coordenats C5  
Campanya 1991

c	c	C	N	NUM.	X	Y	Zsup	Zinf	ORIENT	PENDENT	MATERIA	OBJECTE	LONG	AMPL	ESPE	ALTERACIONS	OBSERVACIONS	P	D	
uX	uY	O	I															ANY	U	I
a	a	N	V																N	B
d	d	J																	T	U
265	555	C	2	147	176	323	0	1710	P		CALCARIA	BNA	0	0	0	NO RECUPERAT		1991	S	
265	555	C	2	148	344	447	0	1720	P		QUARS	BNA	0	0	0	FRAG		1991	S	
265	555	C	2	149	351	759	0	1735	W		SORRENCA	BNA	0	0	0	FRAG		1991	S	
265	555	C	2	150	876	749	0	1718	W		CONGLOME	BNA	0	0	0	FRAG MICROCONGL		1991	S	
265	555	C	3	151	247	166	0	1746	W		RMI	BNA	0	0	0	FRAG		1991	S	
265	555	C	3	152	454	155	0	1733	SW		SORRENCA	BNA	0	0	0			1991	S	
265	555	C	3	153	612	104	0	1742	P		RMI	BNA	0	0	0	FRAG		1991	S	
265	555	C	3	154	604	163	0	1737	SW		QUARS	BNA	0	0	0	FRAG		1991	S	
265	555	C	3	155	724	106	0	1740	S		SORRENCA	BNA	0	0	0	FRAG		1991	S	
265	555	C	3	156	946	48	0	1744			TOVOT	FRAG	0	0	0			1991	S	
265	555	C	2	157	575	928	0	1765	N		QUARS	BNA	0	0	0			1991	S	
265	555	C	2	158	716	808	0	1738	W		CERAMICA	INFORME	0	0	0			1991	S	
265	555	C	2	159	942	653	0	1722			OS	INDET	0	0	0	MOLT FRAGMENTAT		1991	S	
265	555	C	2	160	850	607	0	1723	SW		QUARS	BNA	0	0	0	FRAG		1991	S	
265	555	C	3	162	694	217	0	1745	S		OS	INDET	0	0	0			1991	S	
265	555	C	3	163	214	283	0	1758	SW		SORRENCA	BNA	0	0	0	FRAG		1991	S	
265	555	C	2	164	257	365	0	1722	S		CERAMICA	INFORME	0	0	0			1991	S	
265	555	C	3	165	843	363	0	1792	S		RMI	BNA	0	0	0			1991	S	
265	555	C	2	166	487	765	0	1787	SE		RMI	BNA	0	0	0	FRAG		1991	S	
265	555	C	2	167	501	866	0	1794	P		CERAMICA	INFORME	0	0	0			1991	S	
265	555	C	2	168	454	860	0	1800	NE		CALCARIA	BNA	0	0	0	FRAG		1991	S	
265	555	C	2	169	445	919	0	1797	N		CERAMICA	PANXA	0	0	0			1991	S	
265	555	C	3	170	168	153	0	1807	P		CERAMICA	VORA	0	0	0			1991	S	
265	555	C	3	171	557	248	0	1823	S		RMI	BNA	0	0	0	FRAG		1991	S	
265	555	C	3	172	624	225	0	1805	P		RMI	BNA	0	0	0	FRAG		1991	S	
265	555	C	3	173	851	263	0	1828	W		RMI	BNA	0	0	0	FRAG		1991	S	
265	555	C	3	174	894	45	0	1782	P		CERAMICA	INFORME	0	0	0			1991	S	
265	555	C	2	175	550	826	0	1826	W		CERAMICA	INFORME	0	0	0			1991	S	
265	555	C	3	176	770	23	0	1815			TOVOT	FRAG	0	0	0			1991	S	
265	555	C	3	177	73	184	0	1820	V		QUARSITA	BNA	0	0	0			1991	S	
265	555	C	2	178	260	448	0	1808	NW		CERAMICA	INFORME	0	0	0			1991	S	
265	555	C	3	179	742	470	0	1845	V		CERAMICA	INFORME	0	0	0	3 FRAGS		1991	S	
265	555	C	2	180	438	751	0	1835	P		SORRENCA	BNA	0	0	0	FRAG		1991	S	
265	555	C	3	181	147	243	0	1864	W		CERAMICA	INFORME	0	0	0			1991	S	
265	555	C	3	182	357	239	0	1849	P		QUARS	BNA	0	0	0			1991	S	
265	555	C	3	183	935	443	0	1845	P		CERAMICA	INFORME	0	0	0			1991	S	
265	555	C	2	184	47	883	0	1807	SE		CERAMICA	INFORME	0	0	0			1991	S	
265	555	C	2	185	154	857	0	1854	V		RMI	BNA	0	0	0	FRAG ALTERAT		1991	S	
265	555	C	2	186	461	521	0	1875	P		CERAMICA	INFORME	0	0	0			1991	S	
265	555	C	2	187	251	926	0	1880			ORGANIC	CARBO	0	0	0			1991	S	
265	555	C	2	188	328	838	0	1876			ORGANIC	CARBO	0	0	0			1991	S	
265	555	C	2	189	282	494	0	1904	P		OS	DET	0	0	0	MD		1991	S	
265	555	C	3	191	455	423	0	1892	S		QUARS	BNA	0	0	0	FRAG		1991	S	
265	555	C	3	192	853	835	1782	1845	W		RMI	BNA	0	0	0	FRAG		1991	S	
265	555	C	3	193	131	130	0	1905	V		QUARS	BNA	0	0	0	FRAG		1991	S	
265	555	C	3	194	153	153	0	1890	W		SORRENCA	BNA	0	0	0	FRAG		1991	S	
265	555	C	2	195	161	280	0	1927	P		QUARS	BNA	0	0	0	FRAC		1991	S	
265	555	C	3	196	168	245	0	1891	V		CERAMICA	INFORME	0	0	0			1991	S	
265	555	C	2	198	172	294	0	1807	W		CALCARIA	BNA	0	0	0	NO RECUPERAT		1991	S	
265	555	C	3	199	397	268	0	1896	P		SORRENCA	BNA	0	0	0			1991	S	

103

BOBILA MADURELL  
MAS DURAN  
Objectes Coordenats C5  
Campanya 1991

c c C N												ALTERACIONS	P D						
uX	uY	O	I	NUM.	X	Y	Zsup	Zinf	ORIENT	PENDENT	MATERIA	OBJECTE	LONG	AMPL	ESPE	OBSERVACIONS	ANY	U	I
a	a	N	V														N	B	
d	d	J														T	U		
265	555	C	3	200	770	412	0	1880	P		CERAMICA	INFORME	0	0	0		1991	S	
265	555	C	2	201	200	414	0	1885	P		QUARS	BNA	0	0	0	FRAG	1991	S	
265	555	C	2	202	427	513	0	1885	P		CERAMICA	VORA	0	0	0		1991	S	
265	555	C	3	203	543	544	0	1886	P		QUARS	BNA	0	0	0	FRAG	1991	S	
265	555	C	3	204	60	561	0	1887	P		RMI	BNA	0	0	0	FRAG	1991	S	
265	555	C	2	205	71	713	0	1887	P		CALCARIA	BNA	0	0	0	NO RECUPERAT	1991	S	
265	555	C	2	206	270	796	0	1870			INDET	BNA	0	0	0	FRAG	1991	S	
265	555	C	2	207	656	918	0	1878	V		QUARS	BNA	0	0	0	FRAG	1991	S	
265	555	C	3	208	222	71	0	1927	P		QUARSITA	BPI	0	0	0		1991	S	
265	555	C	3	209	279	79	0	1915	P		CERAMICA	INFORME	0	0	0		1991	S	
265	555	C	3	210	443	28	0	1922	W		CERAMICA	INFORME	0	0	0		1991	S	
265	555	C	3	211	537	132	0	1898	P		CERAMICA	INFORME	0	0	0		1991	S	
265	555	C	3	212	145	195	0	1944	V		RMI	BNA	0	0	0	FRAG	1991	S	
265	555	C	3	213	735	214	0	1908	P		OS	INDET	0	0	0		1991	S	
265	555	C	2	214	82	269	0	1925	W		RMI	BNA	0	0	0	FRAG	1991	S	
265	555	C	2	215	66	321	0	1920	W		QUARS	BNA	0	0	0	NO RECUPERAT	1991	S	
265	555	C	2	216	120	315	0	1920	W		CERAMICA	INFORME	0	0	0	POSSIBLE VORA	1991	S	
265	555	C	3	217	418	445	0	1895	P		OS	INDET	0	0	0		1991	S	
265	555	C	2	218	163	660	0	1899	W		INDET	CODOLF	0	0	0	NO RECUPERAT	1991	S	
265	555	C	3	219	949	781	0	1845	W		SORRENCA	BNA	0	0	0	FRAG	1991	S	
265	555	C	3	220	301	68	0	1985	P		OS	DET	0	0	0	CRA OCND	1991	S	
265	555	C	3	221	119	164	0	1970	V		RMI	BNA	0	0	0		1991	S	
265	555	C	3	222	164	213	0	1965	V		RMI	BNA	0	0	0	FRAG	1991	S	
265	555	C	3	223	972	798	0	1887	W		RMI	BNA	0	0	0	FRAG	1991	S	
265	555	C	3	224	166	881	0	1990	SW		OS	DET	0	0	0	EI	1991	S	
265	555	C	3	225	22	651	0	1915	P		INDET	BNA	0	0	0	FRAG	1991	S	
265	555	C	3	226	349	53	0	1709	S		SORRENCA	BNA	0	0	0	FRAG	1991	S	
265	555	C	2	227	232	893	0	1899	SE		CERAMICA	INFORME	0	0	0		1991	S	
265	555	C	2	228	500	904	0	1850	SE		CERAMICA	INFORME	0	0	0		1991	S	
265	555	C	3	229	715	885	0	1968	S		CALCARIA	BNA	0	0	0		1991	S	
265	555	C	3	230	836	567	0	1934	SW		RMI	BNA	0	0	0		1991	S	
265	555	C	3	231	846	470	0	1950	SW		CALCARIA	BP	0	0	0		1991	S	
265	555	C	3	232	778	970	0	1975	N		CERAMICA	INFORME	0	0	0	TERRA CUITA	1991	S	
265	555	C	3	233	810	708	0	2005	S		CERAMICA	INFORME	0	0	0	TERRA CUITA	1991	S	
265	555	C	3	234	848	896	0	1996			ORGANIC	CARBO	0	0	0		1991	S	
265	555	C	3	235	757	940	0	2004			ORGANIC	CARBO	0	0	0		1991	S	
265	555	C	3	236	670	901	0	2060			ORGANIC	CARBO	0	0	0		1991	S	
265	555	C	3	237	497	980	0	1979	S		CERAMICA	INFORME	0	0	0		1991	S	
265	555	C	3	238	391	752	0	2050	S		CERAMICA	VORA	0	0	0		1991	S	
265	555	C	3	239	440	916	0	2022			ORGANIC	CARBO	0	0	0		1991	S	
265	555	C	3	240	96	883	0	2015	S		CERAMICA	INFORME	0	0	0		1991	S	
265	555	C	3	241	148	822	0	2018	W		CERAMICA	INFORME	0	0	0		1991	S	
265	555	C	3	242	78	548	0	1997	W		CERAMICA	INFORME	0	0	0	FRAG	1991	S	
265	555	C	3	243	18	148	1967	2082			CONGLOME	BNA	0	0	0		1991	S	
265	555	C	3	244	54	45	0	2028	W		QUARS	BNA	0	0	0		1991	S	
265	555	C	3	245	151	981	0	1990	W		CERAMICA	APLICA	0	0	0	MUGRO	1991	S	
265	555	C	3	246	4	548	0	2039	P		TOVOT	FRAG	0	0	0		1991	S	
265	555	C	3	247	16	339	0	2051	W		QUARS	BNA	0	0	0	FRAC	1991	S	
265	555	C	3	248	11	308	0	2098			ORGANIC	CARBO	0	0	0		1991	S	
265	555	C	3	249	30	288	0	2045	W		QUARS	BNA	0	0	0	FRAG	1991	S	

BOBILA MADURELL  
MAS DURAN  
Objectes Coordinats C5  
Campanya 1991

c	c	C	N										ALTERACIONS	P	D				
uX	uY	O	I	NUM.	X	Y	Zsup	Zinf	ORIENT	PENDENT	MATERIA	OBJECTE	LONG	AMPL	ESPE	OBSERVACIONS	ANY	U	I
a	a	N	V															N	B
d	d	J																T	U
265	555	c	3	250	117	83	0	2024	W		CERAMICA	INFORME	0	0	0		1991	S	
265	555	c	3	251	34	684	0	2045	P		SILEX	BPI	0	0	0		1991	S	
265	555	c	3	252	20	454	0	2039	S		QUARS	BNA	0	0	0	FRAC	1991	S	
265	555	c	3	253	71	602	0	2098	P		CERAMICA	VORA	0	0	0		1991	S	
265	555	c	3	254	80	273	0	2079	W		RMI	BNA	0	0	0	FRAG	1991	S	
265	555	c	3	255	97	200	0	2105	W		RMI	BNA	0	0	0	FRAG	1991	S	
265	555	c	3	256	33	911	0	2081	P		OS	INDET	0	0	0		1991	S	
265	556	c		1	244	997	1185	1223	S		CALCARIA	BNA	0	0	0	FRAG	1991	S	
265	556	c		2	198	996	1215	1241	W		CALCARIA	BP	0	0	0		1991	S	
265	556	c		3	180	921	0	1274	S		QUARS	BNA	0	0	0		1991	S	
265	556	c		5	128	958	0	1250			QUARS	BPI	0	0	0		1991	S	
265	556	c		6	156	943	0	1250			QUARS	BPI	0	0	0		1991	S	
265	556	c		7	527	778	0	1295	P		CERAMICA	INFORME	0	0	0	VARIS FRAGS	1991	S	
265	556	c		8	461	878	0	1328	N		CALCARIA	BNA	0	0	0	FRAG	1991	S	
265	556	c		9	442	786	0	1331	P		GRANIT	FRAG	0	0	0		1991		
265	556	c		10	958	241	0	1399	E		QUARS	BNA	0	0	0	FRAG	1991	S	
265	556	c		11	831	477	0	1374	P		OS	DET	0	0	0		1991	S	
265	556	c		12	703	105	0	1440	W		CALCARIA	BNA	0	0	0	FRAC BN1G?	1991	S	
265	556	c		13	959	640	0	1420	W	N-S	CALCARIA	BNA	0	0	0	FRAG	1991	S	
265	556	c	2	14	962	477	0	1484	W		SORRENCA	BNA	0	0	0	FRAG	1991	S	
265	556	c	2	15	545	270	0	1496	SW		SILEX	BN2G	0	0	0	GRATADOR	1991	S	
265	556	c	2	16	106	506	0	1487	W		QUARS	BNA	0	0	0	FRAG	1991	S	
265	556	c	2	17	251	916	0	1492	W		QUARSITA	BNA	0	0	0	FRAG	1991	S	
265	556	c	2	18	799	298	0	1518	P		CALCARIA	BNA	0	0	0		1991	S	
265	556	c	2	19	52	676	0	1491	P		OS	INDET	0	0	0	CREMAT	1991	S	
265	556	c	2	20	660	575	0	1511	SE		SILEX	BPF	0	0	0		1991	S	
265	556	c	2	21	917	657	0	1498	V		ESQUIST	BNA	0	0	0	FRAG	1991	S	
265	556	c	2	22	585	814	1428	1506	P		RMI	BNA	0	0	0	FRAG	1991	S	
265	556	c	2	23	901	854	0	1528	SW		RMI	BNA	0	0	0	FRAG	1991	S	
265	556	c	2	24	812	764	0	1529	N		CERAMICA	INFORME	0	0	0		1991		
265	556	c	2	25	737	846	0	1524	E		ESQUIST	BNA	0	0	0	FRAG	1991	S	
265	556	c	2	26	730	808	0	1531	P		RMI	BNA	0	0	0	FRAG	1991	S	
265	556	c	2	27	684	798	0	1556	W		RMI	BNA	0	0	0	FRAG	1991	S	
265	556	c	2	28	712	913	0	1525	N		SORRENCA	BNA	0	0	0	FRAG	1991	S	
265	556	c	2	29	652	600	0	1535	E		SORRENCA	BNA	0	0	0	ALTERAT	1991	S	
265	556	c	2	30	544	136	0	1530	P		QUARSITA	BPI	0	0	0		1991	S	
265	556	c	2	31	917	277	0	1534	V		CERAMICA	INFORME	0	0	0		1991	S	
265	556	c	2	32	234	468	0	1545	SE		QUARS	BNA	0	0	0	FRAC	1991	S	
265	556	c	2	33	756	565	0	1538	SE		CERAMICA	INFORME	0	0	0		1991	S	
265	556	c	2	34	580	799	0	1562	W		CALCARIA	BNA	0	0	0	FRAG	1991	S	
265	556	c	2	35	641	286	0	1557	W		QUARS	BPI	0	0	0		1991	S	
265	556	c	2	36	663	457	0	1565	E		CALCARIA	BNA	0	0	0	FRAC	1991	S	
265	556	c	2	37	328	630	0	1560	P		QUARS	BPF	0	0	0		1991	S	
265	556	c	2	38	121	630	0	1570	V		OS	DET	0	0	0		1991	S	
265	556	c	2	39	852	836	0	1550			ORGANIC	CARBO	0	0	0		1991	S	
265	556	c	2	40	110	904	0	1575	W		QUARSITA	BNA	0	0	0	FRAG	1991	S	
265	556	c	2	41	219	825	0	1570	P		RMI	BNA	0	0	0	FRAG	1991	S	
265	556	c	2	42	110	904	0	1575	N		QUARS	BNA	0	0	0		1991	S	
265	556	c	2	43	219	825	0	1580	P		RMI	BNA	0	0	0	FRAG	1991	S	
265	556	c	2	44	332	774	0	1577	W		CALCARIA	BNA	0	0	0	FRAG	1991		

BOBILA MADURELL  
MAS DURAN  
Objectes Coordenats C5  
Campanya 1991

c	c	C	N											ALTERACIONS	P	D			
uX	uY	O	I	NUM.	X	Y	Zsup	Zinf	ORIENT	PENDENT	MATERIA	OBJECTE	LONG	AMPL	ESPE	OBSERVACIONS	ANY	U	I
a	a	N	V															N	B
d	d	J																T	U
265	556	C	2	45	325	724	0	1582	NE		CALCARIA	BNA	0	0	0	FRAG ALTERAT	1991	S	
265	556	C	2	47	717	816	0	1587	W		QUARS	BNA	0	0	0		1991	S	
265	556	C	2	48	98	415	0	1580	P		ESQUIST	BNA	0	0	0	FRAG	1991	S	
265	556	C	2	49	575	434	0	1598	P		QUARS	BNA	0	0	0	FRAG	1991	S	
265	556	C	2	50	355	236	0	1611	NW		RMI	BNA	0	0	0	FRAG	1991	S	
265	556	C	2	51	175	971	0	1631	W		QUARSITA	BNA	0	0	0	FRAG	1991	S	
265	556	C	2	52	254	786	0	1628	W		QUARS	BNA	0	0	0	FRAG	1991	S	
265	556	C	2	53	73	712	0	1564	P		QUARS	BNA	0	0	0	NO RECUPERAT	1991	S	
265	556	C	2	54	188	721	0	1588	P		SORRENCA	BNA	0	0	0	NO RECUPERAT	1991	S	
265	556	C	2	55	499	520	0	1611	W		QUARS	BPF	0	0	0		1991	S	
265	556	C	2	56	557	528	0	1597	P		SORRENCA	BNA	0	0	0	NO RECUPERAT	1991	S	
265	556	C	2	57	48	395	0	1646	W		RMI	BNA	0	0	0		1991	S	
265	556	C	2	58	123	380	0	1617	E		ESQUIST	BNA	0	0	0	FRAG	1991	S	
265	556	C	2	59	180	383	0	1615	V		CERAMICA	INFORME	0	0	0		1991	S	
265	556	C	2	60	230	528	0	1625	SW		QUARS	BNA	0	0	0	FRAG	1991	S	
265	556	C	2	61	246	546	0	1618	SW		QUARS	BNA	0	0	0	FRAG	1991	S	
265	556	C	2	62	277	614	0	1610	P		CERAMICA	INFORME	0	0	0		1991	S	
265	556	C	2	63	527	486	0	1620	V		QUARS	BNA	0	0	0	FRAG	1991	S	
265	556	C	2	64	431	807	0	1593	E		RMI	BNA	0	0	0	FRAG	1991	S	
265	556	C	2	65	492	818	0	1605	N		QUARS	FRAG	0	0	0		1991	S	
265	556	C	2	66	297	432	0	1622	SW		QUARS	BNA	0	0	0	FRAG	1991	S	
265	556	C	2	67	614	128	0	1615	W		QUARS	BPF	0	0	0		1991	S	
265	556	C	2	68	194	836	0	1628	NW		CALCARIA	BPI	0	0	0		1991	S	
265	556	C	2	69	310	772	0	1629	SW		QUARS	BNA	0	0	0	FRAG	1991	S	
265	556	C	2	70	175	672	0	1635	P		QUARS	BNA	0	0	0	FRAG	1991	S	
265	556	C	2	71	107	632	0	1640	P		CONGLOME	BNA	0	0	0	MICROCONGLOME	1991	S	
265	556	C	2	72	879	831	0	1610	N		CERAMICA	INFORME	0	0	0		1991	S	
265	556	C	2	73	91	357	0	1662	P		SILEX	BPI	0	0	0		1991	S	
265	556	C	2	74	504	327	0	1647	NW		SORRENCA	BNA	0	0	0	FRAG	1991	S	
265	556	C	2	75	678	329	0	1640	P		CONGLOME	BNA	0	0	0	FRAG MICROCONGL	1991	S	
265	556	C	2	76	123	626	0	1634	P		SORRENCA	BNA	0	0	0	FRAG NO RECUPAR	1991	S	
265	556	C	2	77	498	725	0	1653	P		TOVOT	FRAG	0	0	0		1991	S	
265	556	C	2	78	599	928	0	1641	P		CALCARIA	BPF	0	0	0		1991	S	
265	556	C	2	79	561	994	0	1640	P		OS	INDET	0	0	0		1991	S	
265	556	C	2	80	772	848	0	1660	N		CONGLOME	BNA	0	0	0	FRAG MICROCONGL	1991	S	
265	556	C	2	81	293	892	0	1653	P		CONGLOME	BNA	0	0	0		1991	S	
265	556	C	2	82	129	669	0	1657	E		CALCARIA	BNA	0	0	0	FRAG ALTERAT	1991	S	
265	556	C	2	83	293	892	0	1667	V		QUARS	BNA	0	0	0	FRAC	1991	S	
265	556	C	2	84	129	669	0	1658	W		QUARS	BNA	0	0	0	FRAG	1991	S	
265	556	C	2	85	180	956	0	1689	P		QUARS	BPI	0	0	0		1991	S	
265	556	C	2	86	299	677	0	1671	E		CALCARIA	BNA	0	0	0	FRAG ALTERAT	1991	S	
265	556	C	2	87	403	119	0	1698	S		OS	DET	0	0	0	VT	1991	S	
265	556	C	2	88	128	288	0	1695	S		CONGLOME	BNA	0	0	0	FRAG MICROCONGL	1991	S	
265	556	C	2	89	221	421	0	1699	N		CALCARIA	BN1G	0	0	0	ALTERAT	1991	S	
265	556	C	2	91	500	985	0	1694	P		CERAMICA	INFORME	0	0	0	TERRA CUITA	1991	S	
265	556	C	2	92	704	931	0	1701	P		CERAMICA	INFORME	0	0	0	4 FRAGS	1991	S	
265	556	C	2	93	288	797	0	1722	SW		SORRENCA	FRAG	0	0	0		1991	S	
265	556	C	2	94	246	613	0	1729	V		RMI	BNA	0	0	0		1991	S	
265	556	C	2	95	424	601	0	1710	P		OS	DET	0	0	0		1991	S	
265	556	C	2	96	497	608	0	1711	P		SILEX	BPI	0	0	0		1991	S	

BOBILA MADURELL  
MAS DURAN  
Objectes Coordenats C5  
Campanya 1991

c	c	C	N											ALTERACIONS	P	D			
uX	uY	O	I	NUM.	X	Y	Zsup	Zinf	ORIENT	PENDENT	MATERIA	OBJECTE	LONG	AMPL	ESPE	OBSERVACIONS	ANY	U	I
a	a	N	V												N	B			
d	d	J													T	U			
265	556	C	2	97	697	657	0	1714	P		CERAMICA	APLICA	0	0	0		1991	S	
265	556	C	2	98	597	582	0	1703	V		OS	DET	0	0	0	3 FRAGS	1991	S	
265	556	C	2	99	880	654	0	1684	P		SORRENCA	BNA	0	0	0	FRAG	1991	S	
265	556	C	2	100	37	181	0	1717	NW		INDET	BNE	0	0	0	DESTRAL	1991	S	
265	556	C	2	101	102	163	0	1725	N		SORRENCA	BNA	0	0	0	FRAG	1991	S	
265	556	C	2	102	761	251	0	1706	V		QUARS	BNA	0	0	0	FRAC	1991	S	
265	556	C	2	103	182	257	0	1726	V		QUARSITA	BN1G	0	0	0		1991	S	
265	556	C	2	104	248	332	0	1725	V		INDET	BNA	0	0	0	ALTERAT	1991	S	
265	556	C	2	105	813	732	0	1719	S		CALCARIA	BPF	0	0	0		1991	S	
265	556	C	2	106	736	957	0	1708	E		QUARS	BPI	0	0	0		1991	S	
265	556	C	2	107	151	152	0	1731	P		CALCARIA	BPF	0	0	0		1991	S	
265	556	C	2	108	843	717	0	1735	NE		CALCARIA	CODOL	0	0	0	ALTERAT	1991	S	
265	556	C	2	109	833	817	0	1734	NE		CERAMICA	INFORME	0	0	0		1991	S	
265	556	C	2	110	754	771	0	1719	NE		CERAMICA	PANXA	0	0	0		1991	S	
265	556	C	2	111	479	16	0	1747	W		QUARSITA	BNE	0	0	0		1991	S	
265	556	C	2	112	540	133	0	1742	W		CERAMICA	INFORME	0	0	0		1991	S	
265	556	C	2	113	599	244	0	1740	W		CERAMICA	INFORME	0	0	0	4 FRAGS	1991	S	
265	556	C	2	114	669	388	0	1738	N		OS	DET	0	0	0		1991	S	
265	556	C	2	115	197	379	0	1743	P		CERAMICA	INFORME	0	0	0		1991	S	
265	556	C	2	116	239	154	0	1795	V		QUARS	BNA	0	0	0		1991	S	
265	556	C	2	117	307	108	0	1795	NE		SORRENCA	BNA	0	0	0	FRAG	1991	S	
265	556	C	2	118	684	8	0	1722	SW		CERAMICA	VORA	0	0	0		1991	S	
265	556	C	2	119	505	6	0	1797	P		CERAMICA	INFORME	0	0	0		1991	S	
265	556	C	2	120	607	50	0	1786	P		RMI	BNA	0	0	0		1991	S	
265	556	C	2	121	617	304	0	1749	P		CERAMICA	INFORME	0	0	0		1991	S	
265	556	C	2	122	648	146	0	1757	N		CERAMICA	INFORME	0	0	0		1991	S	
265	556	C	2	123	639	204	0	1752	V		CERAMICA	INFORME	0	0	0		1991	S	
265	556	C	2	124	611	305	0	1757	P		CERAMICA	INFORME	0	0	0		1991	S	
265	556	C	2	125	658	327	0	1756	P		QUARS	BNA	0	0	0	FRAC	1991	S	
265	556	C	2	126	611	305	0	1756	NW		RMI	BNA	0	0	0		1991	S	
265	556	C	2	127	611	648	0	1791	V		QUARS	BNA	0	0	0		1991	S	
265	556	C	2	128	104	280	0	1801	P		ESQUIST	BNA	0	0	0	FRAG	1991	S	
265	556	C	2	129	732	837	0	1534	E		SORRENCA	BNA	0	0	0		1991	S	
265	556	C	2	130	531	231	0	1850	P		CERAMICA	INFORME	0	0	0		1991	S	
265	556	C	2	131	714	303	0	1771	W		CALCARIA	BN1G	0	0	0		1991	S	
265	556	C	2	132	812	591	0	1779	P		ESQUIST	BNA	0	0	0	FRAG	1991	S	
265	556	C	2	133	758	558	0	1751	S		CERAMICA	INFORME	0	0	0		1991	S	
265	556	C	2	134	804	589	0	1748	P		CERAMICA	VORA	0	0	0		1991	S	
265	556	C	2	135	780	726	0	1741	P		CERAMICA	INFORME	0	0	0	ARGILA CUITA	1991	S	
265	556	C	2	136	848	961	0	1725			CERAMICA	INFORME	0	0	0		1991	S	
265	556	C	2	137	892	969	0	1727	P		RMI	BNA	0	0	0	FRAC	1991	S	
265	556	C	2	138	499	43	0	1827	P		CERAMICA	INFORME	0	0	0		1991	S	
265	556	C	2	139	718	473	0	1886	V		INDET	BNA	0	0	0	FRAG	1991	S	
265	556	C	2	140	569	591	0	1890	P		ESQUIST	BNA	0	0	0	FRAG	1991	S	
265	556	C	2	141	675	600	0	1873	P		CERAMICA	INFORME	0	0	0		1991	S	
265	556	C	2	142	821	653	0	1753	P		CERAMICA	INFORME	0	0	0		1991	S	
265	556	C	2	143	967	689	0	1756	W		ESQUIST	BNA	0	0	0	FRAG	1991	S	
265	556	C	2	144	913	855	0	1746	P		SORRENCA	BNA	0	0	0	FRAG	1991	S	
265	556	C	2	145	560	395	0	1791	P		OS	DET	0	0	0		1991	S	
265	556	C	2	146	135	422	0	1832	W		QUARSITA	BPI	0	0	0	FRAC	1991	S	

BOBILA MADURELL  
MAS DURAN  
Objectes Coordinats C5  
Campanya 1991

c	c	C	N	NUM.	X	Y	Zsup	Zinf	ORIENT	PENDENT	MATERIA	OBJECTE	LONG	AMPL	ESPE	ALTERACIONS OBSERVACIONS	P D ANY U I N B T U
uX	uY	O	I														
a	a	N	V														
d	d	J															
265	556	C	2	147	999	999	0	1727	S		CERAMICA	INFORME	0	0	0		1991 S
265	556	C	2	148	988	977	0	1723	SW		CERAMICA	INFORME	0	0	0		1991 S
265	556	C	2	149	457	662	0	1781	N		OS	INDET	0	0	0	VARIS FRAGS	1991 S
265	556	C	2	150	793	389	0	1792	N		RMI	BNA	0	0	0	FRAC	1991 S
265	556	C	2	152	831	937	0	1764	P		CERAMICA	INFORME	0	0	0	FRAG	1991 S
265	556	C	2	153	889	890	0	1783	P		QUARS	BNA	0	0	0	FRAG	1991 S
265	556	C	2	154	956	899	0	1786	SW		ESQUIST	BNA	0	0	0	FRAG	1991 S
265	556	C	2	155	813	836	0	1783	P		SILEX	BNA	0	0	0	FRAG	1991 S
265	556	C	3	156	938	472	0	1866	N		CERAMICA	INFORME	0	0	0		1991 S
265	556	C	3	157	946	723	0	1855	E		CERAMICA	INFORME	0	0	0		1991 S
265	556	C	3	158	893	254	0	1888	E		CERAMICA	APLICA	0	0	0	2 LLENGETES	1991 S
265	556	C	3	159	868	501	0	1876	E		CERAMICA	INFORME	0	0	0		1991 S
265	556	C	3	160	960	153	0	1884			ORGANIC	CARBO	0	0	0		1991 S
265	556	C	3	161	794	3	0	1909	S		CERAMICA	APLICA	0	0	0	VORA LLENGETA	1991 S
265	556	C	3	162	541	17	0	1890	E		CERAMICA	INFORME	0	0	0	ARRENCADA NANSA	1991 S
265	556	C	3	163	606	12	0	1905	E		CERAMICA	INFORME	0	0	0		1991 S
265	556	C	3	164	788	645	0	1935	W		CERAMICA	INFORME	0	0	0		1991 S
265	556	C	3	165	667	99	0	1936	E		CERAMICA	VORA	0	0	0		1991 S
265	556	C	3	166	50	817	0	1906	N		RMI	BNA	0	0	0	FRAG	1991 S
265	556	C	3	167	101	973	0	1900	W		QUARS	BPI	0	0	0		1991 S
265	556	C	3	168	23	988	0	1923	P		CALCARIA	BNA	0	0	0	ALTERAT	1991 S
265	556	C	3	169	607	453	0	1960	N		SORRENCA	BNA	0	0	0	FRAG	1991 S
265	556	C	3	170	82	436	0	1993	W		CERAMICA	PANXA	0	0	0		1991 S
265	556	C	3	171	905	871	0	2035	P		RMI	BNA	0	0	0	FRAG	1991 S
265	557	C		1	13	103	1257	1297	N-S	S	CALCARIA	FRAG	0	0	0		1991
265	557	C		2	302	81	1260	1307	N-S	SE	CALCARIA	FRAG	0	0	0		1991
265	557	C		3	171	184	1130	1160	E-W	N	QUARS	FRAG	0	0	0		1991
265	557	C		4	234	198	1175	1218	E-W	NE	CALCARIA	FRAG	0	0	0		1991
265	557	C		5	706	233	1268	1285	E-W	P	CALCARIA	FRAG	0	0	0		1991
265	557	C		6	328	373	1260	1282			CALCARIA	FRAG	0	0	0		1991
265	557	C		7	119	428	1195	1215	NW-SE	N	CALCARIA	FRAG	0	0	0		1991
265	557	C		8	64	447	1193	1230	NW-SE	V	CALCARIA	CODOLF	0	0	0		1991
265	557	C		9	509	588	1110	1144	N-S	N	CONGLOME	BNA	0	0	0	FRAG	1991 S
265	557	C		10	337	684	1170	1210	E-W	E	QUARS	BNA	0	0	0		1991 S
265	557	C		11	939	871	1192	1220	NW-SE	P	CALCARIA	CODOLF	0	0	0		1991
265	557	C		12	625	710	0	1301	P		RMI	BNA	0	0	0	FRAG	1991 S
265	557	C		13	746	473	0	1306	P		QUARS	BNA	0	0	0	FRAG	1991 S
265	557	C		14	813	457	0	1315	P		QUARS	BPI	0	0	0		1991 S
265	557	C		15	352	327	0	1308	P		QUARS	BP2G	0	0	0		1991 S
265	557	C	2	16	872	357	0	1395	P		CALCARIA	BNA	0	0	0		1991 S
265	557	C	2	17	436	470	0	1350	SE		SILEX	BNA	0	0	0	FRAC	1991 S
265	557	C	2	18	803	656	0	1375	NW		OS	DET	0	0	0		1991 S
265	557	C	2	19	356	879	0	1370	S		RMI	BNA	0	0	0	FRAG	1991 S
265	557	C	2	20	710	585	1355	1392	SW		RMI	BNA	0	0	0	FRAG	1991 S
265	557	C	2	21	930	691	0	1389	NW		CERAMICA	INFORME	0	0	0		1991 S
265	557	C	2	22	952	906	0	1364	SW		RMI	BNA	0	0	0	FRAG	1991 S
265	557	C	2	23	524	139	0	1394	NE		RMI	BNA	0	0	0	FRAG	1991 S
265	557	C	2	24	309	901	0	1374	P		CERAMICA	INFORME	0	0	0		1991 S
265	557	C	2	25	294	946	0	1347	S		QUARSITA	BNA	0	0	0	FRAG	1991 S
265	557	C	2	26	59	848	0	1386			SILEX	BPF	0	0	0	2 FRAGS	1991 S

BOBILA MADURELL  
MAS DURAN  
Objectes Coordenats C5  
Campanya 1991

c	c	C	N											ALTERACIONS			P	D			
uX	uY	O	I	NUM.	X	Y	Zsup	Zinf	ORIENT	PENDENT	MATERIA	OBJECTE	LONG	AMPL	ESPE	OBSERVACIONS	ANY	U	I		
a	a	N	V																	N	B
d	d	J																		T	U
265	557	C	2	27	954	34	0	1418	P		CERAMICA	INFORME	0	0	0		1991				
265	557	C	2	28	630	116	0	1434			OS	DET	0	0	0	MD MICRO	1991	S			
265	557	C	2	29	838	410	0	1429	P		CERAMICA	VORA	0	0	0		1991	S			
265	557	C	2	30	799	570	0	1419	S		CERAMICA	INFORME	0	0	0		1991	S			
265	557	C	2	31	249	442	0	1420			SILEX	BP2G	0	0	0		1991	S			
265	557	C	2	32	836	862	0	1397	S		OS	DET	0	0	0		1991	S			
265	557	C	2	33	908	545	0	1409	S		QUARS	BNA	0	0	0	FRAG	1991	S			
265	557	C	2	34	843	164	0	1428	NE		CERAMICA	INFORME	0	0	0		1991	S			
265	557	C	2	35	789	902	1379	1429	S		RMI	BNA	0	0	0	FRAG	1991	S			
265	557	C	2	36	920	705	1392	1446	SW		CALCARIA	BNA	0	0	0		1991	S			
265	557	C	2	37	950	455	0	1434	E		CERAMICA	VORA	0	0	0	CARENA	1991	S			
265	557	C	2	38	724	477	0	1453	SW		RMI	BNA	0	0	0		1991	S			
265	557	C	2	39	407	932	1403	1427	SE		RMI	BNA	0	0	0	FRAG	1991	S			
265	557	C	2	40	386	740	0	1434	S		RMI	BNA	0	0	0	FRAG	1991	S			
265	557	C	2	41	241	650	0	1433	W		SILEX	BPI	0	0	0		1991	S			
265	557	C	2	42	96	715	1385	1460	SW		RMI	BNA	0	0	0	FRAG	1991	S			
265	557	C	2	43	283	691	0	1450	SE		QUARS	BNA	0	0	0	FRAG	1991	S			
265	557	C	2	44	463	478	0	1452	W		CERAMICA	INFORME	0	0	0		1991	S			
265	557	C	2	45	808	88	0	1458	NW		SILEX	BPI	0	0	0		1991	S			
265	557	C	2	46	813	480	0	1453			OS	INDET	0	0	0	CREMAT	1991	S			
265	557	C	2	47	926	616	0	1444	P		RMI	BNA	0	0	0	FRAG	1991	S			
265	557	C	2	48	845	843	0	1439	SW		RMI	BNA	0	0	0	FRAG	1991	S			
265	557	C	2	49	540	938	0	1432	W		CERAMICA	INFORME	0	0	0		1991	S			
265	557	C	2	50	486	935	0	1442	W		QUARS	BNA	0	0	0	FRAG	1991	S			
265	557	C	2	51	950	654	0	1484	SW		CERAMICA	INFORME	0	0	0		1991	S			
265	557	C	2	52	738	643	0	1468	SW		CERAMICA	APLICA	0	0	0	LLENGUETA	1991	S			
265	557	C	2	53	486	658	0	1465	E		CALCARIA	BNA	0	0	0	FRAG	1991	S			
265	557	C	2	54	504	666	0	1464	N		RMI	BNA	0	0	0	FRAG	1991	S			
265	557	C	2	55	336	977	0	1457	P		RMI	BNA	0	0	0	FRAG	1991	S			
265	557	C	2	56	408	844	0	1462	P		QUARS	BNA	0	0	0		1991	S			
265	557	C	2	57	409	801	0	1485	SE		SORRENCA	BNA	0	0	0	FRAG	1991	S			
265	557	C	2	58	250	784	0	1460	E		CERAMICA	INFORME	0	0	0		1991	S			
265	557	C	2	59	33	790	0	1440	S		QUARS	BNA	0	0	0		1991	S			
265	557	C	2	60	228	888	0	1475	V		CERAMICA	INFORME	0	0	0		1991	S			
265	557	C	2	61	326	842	0	1462	SE		QUARSITA	BNA	0	0	0	FRAG	1991	S			
265	557	C	2	62	646	742	0	1510	SW		QUARS	BNA	0	0	0	FRAC	1991	S			
265	557	C	2	63	514	676	0	1504	P		CALCARIA	BNA	0	0	0	FRAG	1991	S			
265	557	C	2	64	519	609	0	1505	S		QUARS	FRAG	0	0	0		1991				
265	557	C	2	65	929	618	0	1497	W		SORRENCA	BNA	0	0	0	FRAG	1991	S			
265	557	C	2	66	949	520	0	1505	W		SORRENCA	BNA	0	0	0	NO RECUPERAT	1991	S			
265	557	C	2	68	741	304	0	1520	S		SORRENCA	BNA	0	0	0	FRAG	1991	S			
265	557	C	2	70	581	638	0	1490	S		CERAMICA	VORA	0	0	0		1991	S			
265	557	C	2	71	125	332	0	1525	P		QUARS	BNA	0	0	0	FRAG	1991	S			
265	557	C	2	72	316	387	0	1520	P		CERAMICA	INFORME	0	0	0		1991	S			
265	557	C	2	73	664	365	0	1528	SW		CALCARIA	BNA	0	0	0	CREMAT	1991	S			
265	557	C	2	74	354	39	0	1535	NE		CERAMICA	INFORME	0	0	0		1991	S			
265	557	C	2	75	501	165	0	1530	E		CERAMICA	INFORME	0	0	0		1991	S			
265	557	C	2	76	639	105	0	1528	SE		CALCARIA	BNA	0	0	0	FRAG ALTERAT	1991	S			
265	557	C	2	77	701	100	0	1533	V		QUARS	BNA	0	0	0		1991	S			
265	557	C	2	78	726	188	0	1532	P		QUARS	BPI	0	0	0		1991	S			

109



BOBILA MADURELL  
MAS DURAN  
Objectes Coordinats C5  
Campanya 1991

c	c	C	N													ALTERACIONS	P	D
uX	uY	O	I	NUM.	X	Y	Zsup	Zinf	ORIENT	PENDENT	MATERIA	OBJECTE	LONG	AMPL	ESPE	OBSERVACIONS	ANY	U
a	a	N	V															I
d	d	J																N
																		B
																		U
																		T
																		U
265	557	C	2	79	954	154	0	1528	P		QUARS	BNA	0	0	0	FRAG	1991	S
265	557	C	2	80	930	77	0	1557			ORGANIC	CARBO	0	0	0		1991	S
265	557	C	2	81	37	456	0	1542	P		CALCARIA	BPF	0	0	0		1991	S
265	557	C	2	82	239	401	0	1558	V		CERAMICA	INFORME	0	0	0	VARIS FRAGS	1991	S
265	557	C	2	83	37	456	0	1536	NE		CERAMICA	APLICA	0	0	0	MUGRO FRAG	1991	S
265	557	C	2	84	239	401	0	1536	E		CALCARIA	BNA	0	0	0	CREMAT	1991	S
265	557	C	2	85	401	419	1497	1560	V		RMI	BNA	0	0	0		1991	S
265	557	C	2	86	438	330	0	1585	V		CALCARIA	BNA	0	0	0	FRAC	1991	S
265	557	C	2	87	506	381	0	1570	N		RMI	BNA	0	0	0	FRAG	1991	S
265	557	C	2	88	666	320	0	1570	V		QUARS	BNA	0	0	0	FRAG	1991	S
265	557	C	2	89	122	221	0	1580	V		RMI	BNA	0	0	0	FRAG	1991	S
265	557	C	2	90	369	229	0	1590	SW		CALCARIA	BN1G	0	0	0		1991	S
265	557	C	2	91	122	221	0	1570	P		QUARS	BP2G	0	0	0		1991	S
265	557	C	2	92	369	229	0	1585	SW		QUARS	BNA	0	0	0	FRAG	1991	S
265	557	C	2	93	500	223	0	1595	V		CALCARIA	BNA	0	0	0	FRAC	1991	S
265	557	C	2	94	353	164	0	1595	P		QUARS	BNA	0	0	0	FRAC	1991	S
265	557	C	2	95	286	120	0	1570	V		INDET	BNA	0	0	0	FRAG NO RECUPER	1991	S
265	557	C	2	96	621	61	0	1551	SW		CERAMICA	INFORME	0	0	0		1991	S
265	557	C	2	97	601	366	0	1577	P		RMI	BNA	0	0	0	FRAG ALTERAT	1991	S
265	557	C	2	98	605	791	0	1603	P		CERAMICA	INFORME	0	0	0		1991	S
265	557	C	2	99	970	597	0	1575	NW		CERAMICA	INFORME	0	0	0	VARIS FRAGS	1991	S
265	557	C	2	101	709	402	0	1612	V		QUARS	BNA	0	0	0	FRAG	1991	S
265	557	C	2	102	677	222	0	1611	W		CONGLOME	BNA	0	0	0	FRAG	1991	S
265	557	C	2	103	865	228	0	1612	W		OS	DET	0	0	0	FE?	1991	S
265	557	C	2	104	570	142	0	1620	V		SORRENCA	BNA	0	0	0		1991	S
265	557	C	2	105	685	103	0	1627	P		QUARS	BNA	0	0	0	FRAC	1991	S
265	557	C	2	106	664	493	0	1634	V		CALCARIA	BNA	0	0	0	ALTERAT	1991	S
265	557	C	2	107	551	80	0	1631	P		RMI	BNA	0	0	0	FRAG	1991	S
265	557	C	2	108	484	47	0	1621	W		RMI	BNA	0	0	0	FRAG	1991	S
265	557	C	2	109	659	18	0	1622	SW		RMI	BNA	0	0	0	FRAG	1991	S
265	557	C	2	110	864	23	0	1630	V		SORRENCA	BNA	0	0	0	FRAG NO RECUPER	1991	S
265	557	C	2	111	985	298	0	1650	P		QUARS	BNA	0	0	0	FRAG	1991	S
265	557	C	2	112	779	356	0	1665	N		QUARS	BNA	0	0	0		1991	S
265	557	C	2	113	761	350	0	1649	W		CERAMICA	INFORME	0	0	0		1991	S
265	557	C	2	114	976	656	0	1652	P		RMI	BNA	0	0	0	FRAG	1991	S
265	557	C	2	115	969	557	0	1653	NW		CONGLOME	BNA	0	0	0		1991	S
265	557	C	2	116	991	453	0	1653	N		QUARS	BPI	0	0	0		1991	S
265	557	C	2	117	460	751	0	1709	V		SORRENCA	BNA	0	0	0	FRAG	1991	S
265	557	C	2	118	450	675	0	1668	P		QUARSITA	BN1G	0	0	0		1991	S
265	557	C	2	119	781	564	0	1704	P		RMI	BPF	0	0	0		1991	S
265	557	C	2	120	874	583	0	1699	N		SORRENCA	BNA	0	0	0	FRAG	1991	S
265	557	C	2	121	799	512	0	1702	NE		RMI	BNA	0	0	0	FRAG	1991	S
265	557	C	2	122	927	448	0	1694	NE		SORRENCA	BNA	0	0	0	FRAG	1991	S
265	557	C	2	123	868	399	0	1686	SW		CONGLOME	BNA	0	0	0	FRAG	1991	S
265	557	C	2	124	899	345	0	1697	S		SORRENCA	BNA	0	0	0	FRAG	1991	S
265	557	C	2	125	700	348	0	1710	NE		CERAMICA	VORA	0	0	0	2 FRAGS	1991	S
265	557	C	2	126	454	148	0	1713	W		CALCARIA	BN1G	0	0	0		1991	S
265	557	C	2	127	737	400	0	1700	SW		CERAMICA	PANXA	0	0	0	2 FRAGS	1991	S
265	557	C	2	128	653	389	0	1735	E		CERAMICA	INFORME	0	0	0		1991	S
265	557	C	2	129	819	404	0	1683	NW		CERAMICA	VORA	0	0	0		1991	S

BOBILA MADURELL  
MAS DURAN  
Objectes Coordinats C5  
Campanya 1991

c	c	C	N											ALTERACIONS	P	D			
uX	uY	O	I	NUM.	X	Y	Zsup	Zinf	ORIENT	PENDENT	MATERIA	OBJECTE	LONG	AMPL	ESPE	OBSERVACIONS	ANY	U	I
a	a	N	V															N	B
d	d	J																T	U
265	557	c	2	130	710	531	0	1754	E		CERAMICA	INFORME	0	0	0		1991	S	
265	557	c	2	131	300	134	0	1720	S		CERAMICA	INFORME	0	0	0		1991	S	
265	557	c	3	132	857	872	0	1732	P		SORRENCA	BNA	0	0	0	FRAG	1991	S	
265	557	c	3	133	992	853	0	1726	P		OS	DET	0	0	0		1991	S	
265	557	c	3	134	951	766	0	1739	P		OS	DET	0	0	0		1991	S	
265	557	c	3	135	988	776	0	1723	S		OS	DET	0	0	0		1991	S	
265	557	c	3	136	986	732	0	1735	P		OS	DET	0	0	0		1991	S	
265	557	c	3	137	784	679	0	1749	SW		RMI	BNA	0	0	0	FRAG	1991	S	
265	557	c	3	138	694	424	0	1744	NW		SORRENCA	BNA	0	0	0	FRAG	1991	S	
265	557	c	3	139	861	278	0	1728	P		RMI	BNA	0	0	0	FRAG	1991	S	
265	557	c	3	140	726	349	0	1746	P		ORGANIC	CARBO	0	0	0		1991	S	
265	557	c	3	141	861	367	0	1734	P		QUARS	BNA	0	0	0	FRAG	1991	S	
265	557	c	3	142	832	906	0	1769	NW		QUARS	BNA	0	0	0	FRAG	1991	S	
265	557	c	3	148	804	550	0	1759	S		CALCARIA	BNA	0	0	0	FRAG	1991	S	
265	557	c	3	149	809	494	0	1771	V		QUARS	BNA	0	0	0		1991	S	
265	557	c	3	150	851	229	0	1757	N		CERAMICA	INFORME	0	0	0		1991	S	
265	557	c	3	151	865	226	0	1765	N		CERAMICA	INFORME	0	0	0		1991	S	
265	557	c	3	152	968	188	0	1768	P		CERAMICA	INFORME	0	0	0		1991	S	
265	557	c	3	153	930	629	0	1759	P		OS	DET	0	0	0		1991	S	
265	557	c	3	154	935	806	0	1734	W		CERAMICA	INFORME	0	0	0		1991	S	
265	557	c	3	155	974	650	0	1746	P		OS	DET	0	0	0	4 FRAGS	1991	S	
265	557	c	3	158	749	525	0	1770	P		RMI	BNA	0	0	0	FRAG	1991	S	
265	557	c	3	159	865	265	0	1793	N		CERAMICA	INFORME	0	0	0	FRAG	1991	S	
265	557	c	3	160	922	31	0	1784	S		CERAMICA	INFORME	0	0	0	FRAG	1991	S	
265	557	c	3	161	671	576	0	1779	P		ORGANIC	CARBO	0	0	0		1991	S	
265	557	c	3	162	668	667	0	1791	P		ORGANIC	CARBO	0	0	0		1991	S	
265	557	c	3	163	759	676	0	1820	P		CONGLOME	BNA	0	0	0	MICROCONGL FRAG	1991	S	
265	557	c	3	164	563	702	0	1831	W		RMI	BNA	0	0	0	FRAC	1991	S	
265	557	c	3	165	636	710	0	1821	S		RMI	BNA	0	0	0		1991	S	
265	557	c	3	166	643	660	0	1824	P		QUARSITA	BNA	0	0	0		1991	S	
265	557	c	3	167	646	617	0	1824	W		RMI	BNA	0	0	0	FRAG	1991	S	
265	557	c	3	168	507	547	0	1839	P		SORRENCA	BNA	0	0	0	FRAG	1991	S	
265	557	c	3	169	500	496	0	1835	P		CERAMICA	INFORME	0	0	0	FRAG	1991	S	
265	557	c	3	170	561	520	0	1837	P		TOVOT	FRAG	0	0	0		1991	S	
265	557	c	3	171	951	455	0	1780	P		OS	DET	0	0	0	CST	1991	S	
265	557	c	3	172	897	469	0	1798	P		OS	DET	0	0	0	CST	1991	S	
265	557	c	3	173	888	703	0	1843	SW		OS	DET	0	0	0	FRAG CST	1991	S	
265	557	c	3	174	847	333	0	1855	N		CERAMICA	INFORME	0	0	0		1991	S	
265	557	c	3	175	871	657	0	1817	N		OS	INDET	0	0	0		1991	S	
265	557	c	3	176	840	679	0	1820	NE		OS	DET	0	0	0	VT	1991	S	
265	557	c	3	177	991	609	0	1761	N		OS	DET	0	0	0	CST	1991	S	
265	557	c	3	178	979	645	0	1774	NE		OS	DET	0	0	0	CST	1991	S	
265	557	c	3	179	958	640	0	1768	N		OS	DET	0	0	0	CST	1991	S	
265	557	c	3	180	894	599	0	1835	NW		OS	DET	0	0	0	2 CST	1991	S	
265	557	c	3	181	787	577	0	1862	V		OS	DET	0	0	0	VT	1991	S	
265	557	c	3	182	983	347	0	1871	NE		OS	DET	0	0	0		1991	S	
265	557	c	3	183	804	561	0	1867	P		RMI	BNA	0	0	0	FRAG	1991	S	
111	265	557	c	3	184	994	992	0	1830	NE	OS	DET	0	0	0	CST	1991	S	
265	557	c	3	185	960	990	0	1848	N		OS	DET	0	0	0	CST	1991	S	
265	557	c	3	186	903	974	0	1885	NE		OS	DET	0	0	0	VT	1991	S	

BOBILA MADURELL  
MAS DURAN  
Objectes Coordenats C5  
Campanya 1991

c	c	C	N										ALTERACIONS	P	D				
uX	uY	O	I	NUM.	X	Y	Zsup	Zinf	ORIENT	PENDENT	MATERIA	OBJECTE	LONG	AMPL	ESPE	OBSERVACIONS	ANY	U	I
a	a	N	V															N	B
d	d	J																T	U
265	557	C	3	187	926	929	0	1883	NE	OS	DET		0	0	0	VT	1991	S	
265	557	C	3	188	882	913	0	1865	W	OS	DET		0	0	0	CST	1991	S	
265	557	C	3	189	902	893	0	1850	NE	OS	DET		0	0	0		1991	S	
265	557	C	3	190	879	803	0	1834	P	OS	INDET		0	0	0		1991	S	
265	557	C	3	191	930	829	0	1902	SE	RMI	BNA		0	0	0	FRAG	1991	S	
265	557	C	3	192	359	724	0	1905	P	RMI	BNA		0	0	0	FRAG	1991	S	
265	557	C	3	193	865	802	0	1909	NE	GRANIT	BNA		0	0	0	FRAG	1991		
265	557	C	3	194	782	351	0	1896	P	QUARS	BNA		0	0	0	FRAG	1991		
265	557	C	3	195	153	538	0	1929	W	RMI	BNA		0	0	0	FRAG	1991	S	
265	557	C	3	196	286	522	0	1912	NW	RMI	BPF		0	0	0		1991	S	
265	557	C	3	197	403	436	0	1928	NW	SORRENCA	BNA		0	0	0		1991	S	
265	557	C	3	198	300	314	0	1910	NW	CONGLOME	BNA		0	0	0	MICROCONGLOME	1991	S	
265	557	C	3	199	276	61	0	1908	NE	CALCARIA	BNA		0	0	0	ALTERAT	1991	S	
265	557	C	3	200	738	472	0	1910	P	OS	DET		0	0	0		1991	S	
265	557	C	3	201	759	243	0	1920	SW	CERAMICA	INFORME		0	0	0		1991	S	
265	557	C	3	202	771	597	0	1910	W	QUARS	BNA		0	0	0	FRAG	1991	S	
265	557	C	3	203	766	657	0	1925	E	RMI	BNA		0	0	0	FRAG	1991	S	
265	557	C	3	204	951	672	0	1926	P	CERAMICA	VORA		0	0	0	AMB INFLEXIO	1991	S	
265	557	C	3	205	947	893	0	1958	N	SORRENCA	BNA		0	0	0	FRAG	1991	S	
265	557	C	3	206	422	268	0	1925	S	RMI	BPI		0	0	0	FRAG	1991	S	
265	557	C	3	207	143	336	0	1942	E	SORRENCA	BNA		0	0	0	FRAG	1991	S	
265	557	C	3	208	99	224	1882	1951	P	CALCARIA	BNA		0	0	0	ALTERAT	1991	S	
265	557	C	3	209	892	752	0	1944	P	QUARS	BNA		0	0	0		1991	S	
265	557	C	3	210	963	819	0	1940	P	QUARS	BNA		0	0	0	FRAG	1991	S	
265	557	C	3	211	24	918	0	1977	S	OS	INDET		0	0	0		1991	S	
265	557	C	3	212	170	659	0	1986	N	RMI	BNA		0	0	0	FRAG	1991	S	
265	557	C	3	213	742	368	0	1968	P	QUARS	BNA		0	0	0	FRAG	1991	S	
265	557	C	3	214	550	170	0	1974	S	RMI	BNA		0	0	0	FRAG	1991	S	
265	557	C	3	215	560	846	0	2032	W	RMI	BNA		0	0	0	FRAG	1991	S	
265	557	C	3	216	119	143	0	2029	SW	OS	DET		0	0	0		1991	S	
265	557	C	3	217	13	217	0	2054	S	RMI	BNA		0	0	0	FRAG	1991	S	
265	557	C	3	219	307	660	0	2062	P	QUARS	BP		0	0	0		1991	S	
265	557	C	3	220	156	827	0	2066	P	SORRENCA	BNA		0	0	0	ALTERAT	1991	S	
265	557	C	3	221	195	126	0	2087	E	OS	DET		0	0	0	VT	1991	S	
265	557	C	3	222	200	892	0	2039	NE	OS	DET		0	0	0	CST	1991	S	
265	557	C	3	223	243	899	0	2099	S	CALCARIA	BNA		0	0	0	FRAC	1991	S	
265	557	C	3	224	414	861	0	2084	W	OS	DET		0	0	0	VT BOTA	1991	S	
265	557	C	3	225	291	275	0	2139	P	CONGLOME	BNA		0	0	0	MICROCONGLOME	1991	S	
265	557	C	3	226	333	282	0	2123	S	CERAMICA	INFORME		0	0	0		1991	S	
265	557	C	3	227	289	353	0	2135	W	RMI	BNA		0	0	0	FRAG	1991	S	
265	557	C	3	228	151	511	0	2120	W	CERAMICA	INFORME		0	0	0		1991	S	
265	557	C	3	229	267	742	0	2111	P	OS	INDET		0	0	0	VARIS FRAGS	1991	S	
265	557	C	3	230	127	417	0	2129	P	OS	DET		0	0	0		1991	S	
265	557	C	3	231	346	563	0	2134	S	CERAMICA	INFORME		0	0	0	TOVOT	1991	S	
265	557	C	3	232	208	616	0	2163		SORRENCA	BNA		0	0	0	FRAG	1991	S	
265	557	C	3	233	165	854	0	2184	SW	RMI	BNA		0	0	0	FRAG	1991	S	
265	557	C	3	234	43	797	0	2171	NW	RMI	BNA		0	0	0	FRAG	1991	S	
265	557	C	3	235	258	429	0	2164	N	CERAMICA	INFORME		0	0	0	VARIS FRAGS	1991	S	
265	557	C	3	236	141	440	0	2177	S	CERAMICA	INFORME		0	0	0		1991	S	
265	557	C	3	237	28	133	0	2186	P	OS	DET		0	0	0	CST	1991	S	

BOBILA MADURELL  
MAS DURAN  
Objectes Coordenats C5  
Campanya 1991

c c C N			ALTERACIONS											P D					
uX	uY	O	I	NUM.	X	Y	Zsup	Zinf	ORIENT	PENDENT	MATERIA	OBJECTE	LONG	AMPL	ESPE	OBSERVACIONS	ANY	U	I
a a N V														N B					
d d J														T U					
265 558 C	1 984 923	0 1275	S	SORRENCA	FRAG	0	0	0									1991		
265 558 C	2 984 804	0 1235	S	RMI	BNA	0	0	0									1991	S	
265 558 C	3 151 162	0 1251	SE	RMI	BNA	0	0	0									1991	S	
265 558 C	4 615 40	0 1253	V	QUARS	BPI	0	0	0									1991	S	
265 558 C	5 748 0	0 1279	SW	CERAMICA	INFORME	0	0	0									1991	S	
265 558 C	6 233 417	0 1262	SE	SILEX	BP	0	0	0									1991	S	
265 558 C	7 892 709	0 1285	E	QUARS	BNA	0	0	0									1991	S	
265 558 C	8 744 981	0 1276	SE	CONGLOME	BNA	0	0	0				FRAG	MICROCONGL				1991	S	
265 558 C	9 940 956	0 1272	E	SORRENCA	BNA	0	0	0				FRAG	NO RECUPER				1991	S	
265 558 C	10 318 29	0 1323	W	QUARS	BNA	0	0	0									1991	S	
265 558 C	11 484 831	1255 1342	SW	CONGLOME	BNA	0	0	0									1991	S	
265 558 C	12 347 204	0 1330	N	QUARS	BNA	0	0	0				2	FRAGS				1991	S	
265 558 C	13 255 634	0 1350	N	QUARS	BNA	0	0	0				FRAG					1991	S	
265 558 C	14 942 902	0 1314	SW	SORRENCA	BNA	0	0	0				FRAG					1991	S	
265 558 C 2	15 700 276	0 1357	SW	CONGLOME	BNA	0	0	0				MICROCONGLOME					1991	S	
265 558 C 2	16 84 760	0 1340	W	RMI	BNA	0	0	0				FRAG					1991	S	
265 558 C 2	17 383 861	0 1345	E	QUARS	BNA	0	0	0				FRAG					1991	S	
265 558 C 2	18 503 699	0 1355	E	RMI	BNA	0	0	0				FRAG					1991	S	
265 558 C 2	19 131 615	0 1366	V	CALCARIA	BNA	0	0	0									1991	S	
265 558 C 2	20 120 185	0 1372	V	QUARSITA	BNA	0	0	0				FRAG					1991	S	
265 558 C 2	22 401 931	0 1381	NE	QUARS	BNA	0	0	0									1991	S	
265 558 C 2	23 280 980	0 1368	P	CALCARIA	BNA	0	0	0				NO RECUPERAT					1991	S	
265 558 C 2	24 405 568	0 1380	W	CERAMICA	INFORME	0	0	0									1991	S	
265 558 C 2	25 294 925	0 1395	P	CERAMICA	INFORME	0	0	0									1991	S	
265 558 C 2	26 382 719	0 1388	W	CERAMICA	VORA	0	0	0									1991	S	
265 558 C 2	27 473 433	0 1392	S	CERAMICA	INFORME	0	0	0									1991	S	
265 558 C 2	28 852 405	0 1406	P	QUARSITA	BNA	0	0	0				FRAG					1991	S	
265 558 C 2	29 925 578	0 1401	N	SORRENCA	BNA	0	0	0				FRAG	ALTERAT				1991	S	
265 558 C 2	30 757 139	0 1421	V	SORRENCA	CODOL	0	0	0									1991		
265 558 C 2	31 621 124	0 1407	V	CALCARIA	BNA	0	0	0									1991	S	
265 558 C 2	32 636 285	0 1406	S	SORRENCA	BNA	0	0	0									1991	S	
265 558 C 2	33 623 235	0 1404	S	CERAMICA	INFORME	0	0	0									1991	S	
265 558 C 2	34 412 231	0 1396	S	RMI	BNA	0	0	0				FRAG					1991	S	
265 558 C 2	35 260 155	0 1399	S	RMI	BNA	0	0	0				FRAG					1991	S	
265 558 C 2	36 345 611	0 1406	P	CERAMICA	INFORME	0	0	0									1991	S	
265 558 C 2	37 468 634	1369 1420	W	RMI	BNA	0	0	0				FRAG					1991	S	
265 558 C 2	38 629 597	0 1401	P	QUARS	BNA	0	0	0				FRAG					1991	S	
265 558 C 2	39 682 317	0 1391	W	QUARS	BNA	0	0	0									1991	S	
265 558 C 2	40 843 338	0 1428	W	RMI	BNA	0	0	0									1991	S	
265 558 C 2	41 467 40	0 1419	W	RMI	BNA	0	0	0				FRAG					1991	S	
265 558 C 2	42 341 987	0 1381	P	RMI	BNA	0	0	0				FRAG					1991	S	
265 558 C 2	43 372 770	0 1410	V	SORRENCA	BNA	0	0	0				NO RECUPERAT					1991	S	
265 558 C 2	44 530 247	0 1404	SW	SORRENCA	BNA	0	0	0				NO RECUPERAT					1991	S	
265 558 C 2	45 548 107	0 1415	SW	CERAMICA	INFORME	0	0	0									1991	S	
265 558 C 2	46 303 790	0 1421	N	RMI	BNA	0	0	0				FRAG					1991	S	
265 558 C 2	47 108 170	0 1435	S	CALCARIA	BPI	0	0	0									1991	S	
265 558 C 2	48 425 286	0 1455	N	QUARS	BNA	0	0	0				FRAG					1991	S	
265 558 C 2	49 434 713	0 1474	SW	CERAMICA	INFORME	0	0	0				TERRA	CUITA				1991	S	
265 558 C 2	50 48 446	0 1482	P	RMI	BNA	0	0	0				FRAG					1991	S	
265 558 C 2	51 565 186	0 1479	W	RMI	BNA	0	0	0				FRAG					1991	S	

BOBILA MADURELL  
MAS DURAN  
Objectes Coordenats C5  
Campanya 1991

c	c	C	N										ALTERACIONS	P	D				
uX	uY	O	I	NUM.	X	Y	Zsup	Zinf	ORIENT	PENDENT	MATERIA	OBJECTE	LONG	AMPL	ESPE	OBSERVACIONS	ANY	U	I
a	a	N	V															N	B
d	d	J																T	U
265	558	C	2		52	30	7	0	1489	S	CERAMICA	VORA	0	0	0		1991	S	
265	558	C	2		53	206	909	0	1440	P	RMI	BNA	0	0	0	FRAG	1991	S	
265	558	C	2		54	294	91	0	1445	P	PISSARRA	BNA	0	0	0	FRAG	1991	S	
265	558	C	2		55	206	909	0	1475	P	SORRENCA	BNA	0	0	0	FRAG	1991	S	
265	558	C	2		56	350	956	0	1496	P	CERAMICA	INFORME	0	0	0		1991	S	
265	558	C	2		57	77	914	0	1503	E	CERAMICA	INFORME	0	0	0		1991	S	
265	558	C	2		58	253	385	0	1485	E	RMI	BNA	0	0	0	FRAG	1991	S	
265	558	C	2		59	289	414	0	1498	NE	RMI	BNA	0	0	0	FRAG	1991	S	
265	558	C	2		60	202	907	0	1526	SE	CERAMICA	VORA	0	0	0		1991	S	
265	558	C	2		61	191	866	0	1542	SE	CERAMICA	INFORME	0	0	0		1991	S	
265	558	C	2		62	263	461	0	1540	P	CERAMICA	INFORME	0	0	0		1991	S	
265	558	C	2		63	772	663	0	1564	P	CERAMICA	INFORME	0	0	0		1991	S	
265	558	C	2		64	802	635	0	1610	NW	CERAMICA	INFORME	0	0	0	FRAGMENTAT	1991	S	
265	558	C	2		65	645	586	0	1445	P	RMI	BNA	0	0	0	FRAG	1991	S	
265	558	C	2		66	643	506	0	1622	NW	RMI	BPF	0	0	0		1991	S	
265	558	C	3		67	265	266	0	1670	W	RMI	BNA	0	0	0	FRAG	1991	S	
265	558	C	3		68	954	873	0	1712	P	CERAMICA	INFORME	0	0	0		1991	S	
265	558	C	3		69	764	968	0	1721	P	ORGANIC	CARBO	0	0	0		1991	S	
265	558	C	3		70	648	956	0	1737	P	ORGANIC	CARBO	0	0	0		1991	S	
265	558	C	3		71	762	879	0	1755	P	ORGANIC	CARBO	0	0	0		1991	S	
265	558	C	3		72	330	838	0	1781	P	CERAMICA	INFORME	0	0	0	VARIOS FRAGS	1991	S	
265	558	C	3		73	570	830	0	1775	P	CERAMICA	INFORME	0	0	0		1991	S	
265	558	C	3		74	651	641	0	1799	P	CERAMICA	INFORME	0	0	0	VARIS FRAGS	1991	S	
265	558	C	3		75	803	240	0	1814	S	TOVOT	FRAG	0	0	0	TUBOT	1991	S	
265	558	C	3		76	948	102	0	1796	N	RMI	BNA	0	0	0	FRAC	1991	S	
265	558	C	3		77	525	445	0	1835	N	OS	DET	0	0	0	VT	1991	S	
265	558	C	3		78	869	466	0	1851	E	RMI	BNA	0	0	0	FRAG	1991	S	
265	558	C	3		79	959	551	0	1905	SE	QUARS	BNA	0	0	0	FRAG	1991	S	
265	558	C	3		80	975	648	0	1895	P	CALCARIA	BNA	0	0	0		1991	S	
265	558	C	3		81	262	34	1835	1920	P	QUARS	BNA	0	0	0	FRAG	1991	S	
265	558	C	3		82	296	159	0	1901	W	RMI	BNA	0	0	0	FRAG	1991	S	
265	558	C	3		83	720	338	0	1869	P	RMI	BNA	0	0	0	FRAG	1991	S	
265	558	C	3		84	802	482	1803	1858	P	RMI	BNA	0	0	0	FRAG	1991	S	
265	558	C	3		85	735	639	0	1869	V	CERAMICA	INFORME	0	0	0		1991	S	
265	558	C	3		86	768	658	0	1862	P	QUARS	BPI	0	0	0		1991	S	
265	558	C	3		87	746	973	0	1880	S	RMI	BNA	0	0	0	FRAG	1991	S	
265	558	C	3		88	339	67	0	1907	P	RMI	BNA	0	0	0		1991	S	
265	558	C	3		89	810	768	0	1925	N	CERAMICA	INFORME	0	0	0		1991	S	
265	558	C	3		90	674	819	0	1923	P	CERAMICA	APLICA	0	0	0	2 LLENGUET VORA	1991	S	
265	558	C	3		91	381	963	0	1950	SE	RMI	BNA	0	0	0	FRAG	1991	S	
265	558	C	3		92	498	995	0	1943	NE	ESQUIST	BNA	0	0	0		1991	S	
265	558	C	3		93	594	329	0	1957	P	OS	DET	0	0	0	DENT	1991	S	
265	558	C	3		94	885	978	0	2000	NW	QUARS	BNA	0	0	0	FRAG	1991	S	
265	558	C	3		95	859	301	0	1985	P	RMI	BNA	0	0	0	FRAG	1991	S	
265	558	C	3		96	650	603	0	2022	N	RMI	BNA	0	0	0	FRAG	1991	S	
265	558	C	3		97	798	803	0	2019	NW	RMI	BNA	0	0	0	FRAG	1991	S	
265	558	C	3		98	26	146	0	2045	NW	RMI	BNA	0	0	0	FRAG	1991	S	
265	558	C	3		99	5	225	0	2062	N	RMI	BNA	0	0	0		1991	S	
265	558	C	3		100	421	245	0	2004	P	RMI	BNA	0	0	0	FRAG	1991	S	
265	558	C	3		101	464	348	0	2009	P	CONGLOME	BNA	0	0	0	FRAG MICROCONGL	1991	S	

BOBILA MADURELL  
MAS DURAN  
Objectes Coordenats C5  
Campanya 1991

c	c	C	N										ALTERACIONS	P	D				
uX	uY	O	I	NUM.	X	Y	Zsup	Zinf	ORIENT	PENDENT	MATERIA	OBJECTE	LONG	AMPL	ESPE	OBSERVACIONS	ANY	U	I
a	a	N	V															N	B
d	d	J																T	U
265	558	C	3	102	62	816	0	2040	N		SORRENCA	BNA	0	0	0		1991	S	
265	558	C	3	103	452	916	0	2015	P		QUARS	BNA	0	0	0	FRAG	1991	S	
265	558	C	3	104	617	207	0	2025	P		RMI	BNA	0	0	0		1991	S	
265	558	C	3	105	693	146	0	2015	S		RMI	BNA	0	0	0		1991	S	
265	558	C	3	106	204	550	0	2045	P		RMI	BNA	0	0	0	FRAG	1991	S	
265	558	C	3	107	81	959	0	2052	P		ESQUIST	BNA	0	0	0	FRAG	1991	S	
265	558	C	3	108	67	933	0	2062	N		CERAMICA	INFORME	0	0	0		1991	S	
265	558	C	3	109	171	971	0	2060	S		CERAMICA	VORA	0	0	0		1991	S	
265	558	C	3	110	57	739	0	2070	P		CONGLOME	BNA	0	0	0	MICROCONGLOME	1991	S	
265	558	C	3	111	467	35	0	2072	N		SORRENCA	BNA	0	0	0		1991	S	
265	558	C	3	112	652	153	0	2082	P		CERAMICA	INFORME	0	0	0	VARIS FRAGS	1991	S	
265	558	C	3	113	121	100	0	2199	E		CERAMICA	APLICA	0	0	0	MAMELO	1991	S	
265	558	C	3	114	100	302	0	2151	P		CALCARIA	BNA	0	0	0	FRAC	1991	S	
265	558	C	3	115	407	342	0	2159	N		CERAMICA	INFORME	0	0	0		1991	S	
265	558	C	3	116	273	640	0	2171	NW		ESQUIST	BNA	0	0	0	FRAG	1991	S	
265	558	C	3	117	200	528	0	2185	P		CERAMICA	VORA	0	0	0		1991	S	
265	558	C	3	118	45	236	0	2179	NE		CALCARIA	BNA	0	0	0		1991	S	
265	558	C	3	119	308	209	0	2214	NW		RMI	BNA	0	0	0	FRAG	1991	S	
265	558	C	3	120	857	550	0	2226	P		CERAMICA	APLICA	0	0	0	MAMELO	1991	S	
265	558	C	3	121	804	706	0	2226	N		RMI	BNA	0	0	0	FRAG	1991	S	
265	558	C	3	122	825	831	0	2229	N		CERAMICA	INFORME	0	0	0		1991	S	
265	558	C	3	123	926	958	0	2229			CERAMICA	INFORME	0	0	0	TOVOT	1991	S	
265	558	C	3	124	927	777	0	2248	N		CERAMICA	INFORME	0	0	0		1991	S	
265	558	C	3	125	845	740	0	2226			CERAMICA	INFORME	0	0	0	TOVOT	1991	S	
265	558	C	3	126	894	673	0	2208			CERAMICA	INFORME	0	0	0	TOVOT	1991	S	
265	558	C	3	127	201	946	0	2268	N		CERAMICA	APLICA	0	0	0	MAMELO	1991	S	
265	559	C	2	1	243	857	0	1276	P		INDET	BNA	0	0	0	FRAG	1991	S	
265	559	C	2	2	21	457	0	1296	SW		CALCARIA	BP	0	0	0		1991	S	
265	559	C	2	3	241	361	0	1344	W		INDET	BNA	0	0	0	FRAG	1991	S	
265	559	C	2	4	65	472	0	1353			OS	INDET	0	0	0	VARIS FRAGS	1991	S	
265	559	C	2	5	252	565	0	1355	NE		RMI	BNA	0	0	0	FRAG	1991	S	
265	559	C	2	6	236	773	0	1341	P		RMI	BNA	0	0	0	FRAC ALTERAT	1991	S	
265	559	C	2	7	176	215	0	1329	E		QUARS	BPI	0	0	0		1991	S	
265	559	C	2	8	202	406	0	1400	NE		SORRENCA	BNA	0	0	0	FRAG	1991	S	
265	559	C	2	9	359	25	0	1404	NE		CALCARIA	BNA	0	0	0	FRAG	1991	S	
265	559	C	2	10	172	182	0	1362	P		QUARSITA	BNA	0	0	0		1991	S	
265	559	C	2	11	67	528	0	1418	P		SORRENCA	BNA	0	0	0	FRAG	1991	S	
265	559	C	2	12	471	45	0	1395	S		QUARS	BNA	0	0	0		1991	S	
265	559	C	2	13	562	29	0	1403	SW		CALCARIA	BPF	0	0	0		1991	S	
265	559	C	2	14	47	174	0	1401	P		QUARS	BNA	0	0	0		1991	S	
265	559	C	2	15	20	40	0	1425	NE-SW	P	CERAMICA	INFORME	0	0	0		1991	S	
265	559	C	2	16	130	45	0	1455	E-W	V	CERAMICA	INFORME	0	0	0		1991	S	
265	559	C	2	17	80	105	0	1441	E-W	P	CERAMICA	APLICA	0	0	0	MUGRO	1991	S	
265	559	C	2	18	200	90	0	1447	NW-SE	V	QUARS	BPI	0	0	0		1991	S	
265	559	C	2	19	230	30	0	1495	NW-SE	SE	SORRENCA	BNA	0	0	0	FRAG	1991	S	
265	559	C	2	21	150	400	0	1443	E-W	P	RMI	BNA	0	0	0	FRAG	1991	S	
265	559	C	2	22	435	530	0	1479	NE-SW	NE	CERAMICA	INFORME	0	0	0		1991	S	
265	559	C	2	23	380	102	0	1505	NW		CALCARIA	BNA	0	0	0	FRAG	1991	S	
265	559	C	2	24	366	269	0	1510	P		SILEX	BPF	0	0	0		1991	S	
265	559	C	2	25	202	125	0	1577	V		RMI	BNA	0	0	0		1991	S	

BOBILA MADURELL  
MAS DURAN  
Objectes Coordenats C5  
Campanya 1991

c	c	C	N										ALTERACIONS	P	D				
uX	uY	O	I	NUM.	X	Y	Zsup	Zinf	ORIENT	PENDENT	MATERIA	OBJECTE	LONG	AMPL	ESPE	OBSERVACIONS	ANY	U	I
a	a	N	V															N	B
d	d	J																T	U
265	559	C	2		26	21	157	0	1577	SW	QUARS	BNA	0	0	0	FRAG	1991	S	
265	559	C	3		27	137	64	0	1585	P	CERAMICA	INFORME	0	0	0		1991	S	
265	559	C	3		28	268	669	0	1550	P	QUARS	BNA	0	0	0	FRAC	1991	S	
265	559	C	3		29	835	146	0	0	V	ORGANIC	CARBO	0	0	0		1991	S	
265	559	C	3		30	197	401	0	1576	P	RMI	BNA	0	0	0	FRAG	1991	S	
265	559	C	3		31	109	211	0	1603	P	CERAMICA	INFORME	0	0	0	FRAG	1991	S	
265	559	C	3		32	303	110	0	1590	P	ESQUIST	BNA	0	0	0	FRAG	1991	S	
265	559	C	3		33	199	332	0	1606	P	CERAMICA	INFORME	0	0	0	FRAG	1991	S	
265	559	C	3		34	670	125	0	1682	NW	CERAMICA	INFORME	0	0	0	VARIS FRAGS	1991	S	
265	559	C	3		35	679	179	0	1682	P	ORGANIC	CARBO	0	0	0		1991	S	
265	559	C	3		36	56	362	0	1640	SE	CERAMICA	INFORME	0	0	0	VARIS FRAGS	1991	S	
265	559	C	3		37	254	629	0	1646	P	CERAMICA	INFORME	0	0	0	VARIS FRAGS	1991	S	
265	559	C	3		38	304	261	0	1676	P	ORGANIC	CARBO	0	0	0		1991	S	
265	559	C	3		39	627	192	0	1689	P	CERAMICA	INFORME	0	0	0		1991	S	
265	559	C	3		40	869	69	0	1716	P	CERAMICA	INFORME	0	0	0	VARIS FRAGS	1991	S	
265	559	C	3		41	906	677	0	1714	SW	QUARS	BNA	0	0	0	FRAC	1991	S	
265	559	C	3		42	566	122	0	1753	E	CERAMICA	INFORME	0	0	0	VARIS FRAGS	1991	S	
265	559	C	3		43	153	465	0	1729		ORGANIC	CARBO	0	0	0		1991	S	
265	559	C	3		44	867	52	0	1747	P	CERAMICA	INFORME	0	0	0	2 FRAGS	1991	S	
265	559	C	3		45	352	457	0	1735		ORGANIC	CARBO	0	0	0		1991	S	
265	559	C	3		46	489	503	0	1736	E	CERAMICA	INFORME	0	0	0		1991	S	
265	559	C	3		47	411	449	0	1700	N	TOVOT	FRAG	0	0	0		1991	S	
265	559	C	3		48	546	353	0	1727	P	TOVOT	FRAG	0	0	0	NO RECUPERAT	1991	S	
265	559	C	3		49	925	751	0	1722	W	TOVOT	FRAG	0	0	0		1991	S	
265	559	C	3		50	515	105	0	1757	NW	TOVOT	FRAG	0	0	0	NO RECUPERAT	1991	S	
265	559	C	3		51	519	752	0	1738	N	ORGANIC	CARBO	0	0	0		1991	S	
265	559	C	3		52	455	451	0	1842	NW	CERAMICA	INFORME	0	0	0		1991	S	
265	559	C	3		53	399	375	0	1852	P	TOVOT	FRAG	0	0	0		1991	S	
265	559	C	3		54	667	424	0	1838	SE	CERAMICA	INFORME	0	0	0		1991	S	
265	559	C	3		55	902	703	0	1815	SE	PISSARRA	BNA	0	0	0	FRAG	1991	S	
265	559	C	3		56	759	542	0	1840	SE	CERAMICA	INFORME	0	0	0		1991	S	
265	559	C	3		57	508	401	0	1862	P	RMI	BNA	0	0	0	FRAG	1991	S	
265	559	C	3		58	305	414	0	1884	E	CONGLOME	BNA	0	0	0	MICROCONGL FRAG	1991	S	
265	559	C	3		59	489	638	0	1850	P	RMI	BNA	0	0	0	FRAG	1991	S	
265	559	C	3		60	586	675	0	1858	N	SORRENCA	BNA	0	0	0		1991	S	
265	559	C	3		61	911	61	0	1986	P	OS	DET	0	0	0		1991	S	
265	559	C	3		62	141	139	0	2024	P	RMI	BN1G	0	0	0		1991	S	
265	559	C	3		63	824	143	0	2039	P	RMI	BNA	0	0	0	FRAG	1991	S	
265	559	C	3		64	952	79	0	2054	W	CERAMICA	INFORME	0	0	0		1991	S	
265	559	C	3		65	739	50	0	2090	N	CERAMICA	APLICA	0	0	0	MAMELLO	1991	S	
265	559	C	3		66	156	62	0	2085	P	CONGLOME	BNA	0	0	0	MICROCONGLOME	1991	S	
265	559	C	3		67	139	147	0	2107	V	CALCARIA	BNA	0	0	0		1991	S	
265	559	C	3		68	203	157	0	2119	P	RMI	BNA	0	0	0	FRAG	1991	S	
265	559	C	3		69	262	128	0	2109	N	ESQUIST	BNA	0	0	0	FRAG	1991	S	
265	559	C	3		70	277	182	0	2112	P	CALCARIA	BN1G	0	0	0		1991	S	
265	559	C	3		71	279	209	0	2067	P	QUARS	BPI	0	0	0		1991	S	
265	559	C	3		72	31	33	0	1980	S	CERAMICA	INFORME	0	0	0		1991	S	
265	559	C	3		73	287	552	0	1981	N	CONGLOME	BNA	0	0	0	FRAG MICROCONGL	1991	S	
265	559	C	3		74	299	52	0	2031	S	CALCARIA	BNA	0	0	0	FRAG ALTERAT	1991	S	
265	559	C	3		75	119	361	0	2016	P	CERAMICA	INFORME	0	0	0		1991	S	

01/28/92

BOBILA MADURELL  
 MAS DURAN  
 Objectes Coordinats C5  
 Campanya 1991

c	c	C	N	NUM.	X	Y	Zsup	Zinf	ORIENT	PENDENT	MATERIA	OBJECTE	LONG	AMPL	ESPE	ALTERACIONS	OBSERVACIONS	P D	ANY	U I	N B	T U	
265	559	C	3	76	698	675	0	2003	N		CALCARIA	BN1G	0	0	0			1991	S				
265	559	C	3	77	983	316	0	2079	S		CALCARIA	BNA	0	0	0	FRAC		1991	S				
265	559	C	3	78	951	43	0	2090	W		SORRENCA	BNA	0	0	0	FRAG		1991	S				
265	559	C	3	79	877	59	0	2094	P		RMI	BNA	0	0	0	FRAG		1991	S				
265	559	C	3	80	656	209	0	2054	P		RMI	BNA	0	0	0	FRAG		1991	S				
265	559	C	3	81	855	694	0	2044	V		RMI	BNA	0	0	0	FRAG		1991	S				
265	559	C	3	82	638	648	0	2054	P		RMI	BNA	0	0	0	FRAC		1991	S				
265	559	C	3	83	439	454	0	2059	S		CERAMICA	INFORME	0	0	0			1991	S				
265	559	C	3	84	260	846	0	2028	W		OS	DET	0	0	0			1991	S				
265	559	C	3	85	940	367	0	2078	S		CERAMICA	INFORME	0	0	0			1991	S				
265	559	C	3	86	970	249	0	2090			QUARS	BNA	0	0	0			1991	S				
265	559	C	3	87	738	133	0	2076	SW		RMI	BNA	0	0	0	FRAG		1991	S				
265	559	C	3	88	711	233	0	2062	W		RMI	BNA	0	0	0	FRAG		1991	S				
265	559	C	3	89	700	299	0	2070	S		RMI	BNA	0	0	0	FRAG		1991	S				
265	559	C	3	90	496	485	0	2079	P		RMI	BNA	0	0	0			1991	S				
265	559	C	3	91	477	538	0	2078	P		CERAMICA	INFORME	0	0	0			1991	S				
265	559	C	3	92	418	520	0	2086			CALCARIA	BNA	0	0	0	FRAG	ALTEART	1991	S				
265	559	C	3	93	355	572	0	2074	V		CONGLOME	BNA	0	0	0			1991	S				
265	559	C	3	94	399	644	0	2067			QUARS	BNA	0	0	0	FRAC		1991	S				
265	559	C	3	95	288	776	0	2059	S		QUARS	BNA	0	0	0	FRAC		1991	S				
265	559	C	3	96	265	957	0	2045	S		INDET	BNA	0	0	0			1991	S				
265	559	C	3	97	757	142	0	2105	W		RMI	BNA	0	0	0	FRAG		1991	S				
265	559	C	3	98	597	355	0	2105			QUARS	BNA	0	0	0	FRAC		1991	S				
265	559	C	3	99	555	782	0	2090	W		RMI	BNA	0	0	0	FRAG		1991	S				
265	559	C	3	100	241	894	0	2060	S		CONGLOME	BNA	0	0	0	FRAG	MICROCONGL	1991	S				
265	559	C	3	101	501	101	0	2088	SW		RMI	BNA	0	0	0	FRAG		1991	S				
265	559	C	3	102	310	106	0	2103	N		GRANIT	BNA	0	0	0	FRAG		1991	S				
265	559	C	3	103	413	186	0	2086	E		CONGLOME	BNA	0	0	0	FRAG	MICROCONGL	1991	S				
265	559	C	3	104	339	333	0	2109	N		RMI	BNA	0	0	0	FRAG		1991	S				
265	559	C	3	105	429	376	0	2109	N		RMI	BNA	0	0	0	FRAC		1991	S				
265	559	C	3	106	540	391	0	2078	P		CALCARIA	BNA	0	0	0			1991	S				
265	559	C	3	107	608	321	0	2057	SW		OS	INDET	0	0	0			1991	S				
265	559	C	3	108	721	407	0	2078	N		CONGLOME	BNA	0	0	0	FRAG	MICROCONGL	1991	S				
265	559	C	3	109	961	413	0	2060	E		RMI	BNA	0	0	0	FRAG		1991	S				
265	559	C	3	110	928	578	0	2085	P		QUARSITA	BNA	0	0	0	FRAG		1991	S				
265	559	C	3	111	815	562	0	2076	P		RMI	BNA	0	0	0	FRAG		1991	S				
265	559	C	3	112	759	541	0	2087	S		CALCARIA	BNA	0	0	0	FRAG	ALTERAT	1991	S				
265	559	C	3	113	506	152	0	2090	S		RMI	BNA	0	0	0	FRAG		1991	S				
265	559	C	3	114	652	290	0	2105	SE		CALCARIA	BNA	0	0	0	FRAG		1991	S				
265	559	C	3	115	807	272	0	2109	P		OS	INDET	0	0	0			1991	S				
265	559	C	3	116	943	356	0	2102	P		RMI	BNA	0	0	0	FRAG		1991	S				
265	559	C	3	117	667	377	0	2078	SW		CERAMICA	INFORME	0	0	0			1991	S				
265	559	C	3	118	803	521	0	2101	P		CONGLOME	BNA	0	0	0	MICROCONGLOME		1991	S				
265	559	C	3	119	540	462	0	2067	P		OS	DET	0	0	0			1991	S				
265	559	C	3	120	967	769	0	2064	P		QUARS	BNA	0	0	0	FRAC		1991	S				
265	559	C	3	121	769	281	0	2172	P		OS	INDET	0	0	0			1991	S				
265	559	C	3	122	857	279	0	2116	N		CERAMICA	INFORME	0	0	0			1991	S				
265	559	C	3	123	886	331	0	2115	P		CERAMICA	INFORME	0	0	0			1991	S				
265	559	C	3	124	913	419	0	2147	P		CONGLOME	BNA	0	0	0	FRAG	MICROCONGL	1991	S				
265	559	C	3	125	805	433	0	2153	E		QUARSITA	BNA	0	0	0	FRAC		1991	S				



BOBILA MADURELL  
MAS DURAN  
Objectes Coordenats C5  
Campanya 1991

c	c	C	N											ALTERACIONS		P	D		
uX	uY	O	I	NUM.	X	Y	Zsup	Zinf	ORIENT	PENDENT	MATERIA	OBJECTE	LONG	AMPL	ESPE	OBSERVACIONS	ANY	U	I
a	a	N	V															N	B
d	d	J																T	U
265	559	C	3	126	615	413	0	2131	N		CONGLOME	BNA	0	0	0	FRAG MICROCONGL	1991	S	
265	559	C	3	127	643	558	0	2135	S		RMI	BNA	0	0	0		1991	S	
265	559	C	3	128	751	365	0	2144	NE		OS	DET	0	0	0	MD	1991	S	
265	559	C	3	129	761	521	0	2160	N		RMI	BNA	0	0	0	FRAG	1991	S	
265	559	C	3	130	782	601	0	2170	P		OS	DET	0	0	0	FRAG MD	1991	S	
265	559	C	3	131	788	696	0	2150	S		CONGLOME	BNA	0	0	0	FRAG	1991	S	
265	559	C	3	132	929	629	0	2167	P		CERAMICA	INFORME	0	0	0		1991	S	
265	559	C	3	133	654	444	0	2220	V		QUARSITA	BNA	0	0	0		1991	S	
265	559	C	3	134	604	92	0	2229	N		SORRENCA	BNA	0	0	0	FRAG	1991	S	
265	559	C	3	135	474	130	0	2265	W		RMI	BNA	0	0	0	FRAG	1991	S	
265	559	C	3	136	373	172	0	2285	V		QUARSITA	BNA	0	0	0	FRAG	1991	S	
265	559	C	3	137	861	133	0	2278	P		QUARSITA	BNA	0	0	0	FRAG	1991	S	
265	560	C		1	522	31	0	1266	P		SORRENCA	BNA	0	0	0	FRAG	1991	S	
265	560	C		2	247	131	0	1285	S		CERAMICA	INFORME	0	0	0		1991	S	
265	560	C		3	304	414	0	1318	W		RMI	BNA	0	0	0	FRAG	1991	S	
265	560	C		4	326	461	0	1296	P		CALCARIA	BNA	0	0	0	FRAG	1991	S	
265	560	C		5	370	504	0	1299	SW		RMI	BNA	0	0	0	FRAG	1991	S	
265	560	C		6	334	524	0	1278	NW		CERAMICA	INFORME	0	0	0		1991	S	
265	560	C	3	7	238	60	0	1376	W		SORRENCA	BNA	0	0	0	FRAG	1991	S	
265	560	C	3	8	500	170	0	1429	P		SORRENCA	BNA	0	0	0	FRAG	1991	S	
265	560	C	3	9	350	410	0	1414	P		CALCARIA	BPF	0	0	0		1991	S	
265	560	C	3	10	232	189	0	1460	SE		QUARS	BNA	0	0	0	FRAG	1991	S	
265	560	C	3	11	444	23	1335	1531	SW		CONGLOME	BNA	0	0	0	MICROCONGLOME	1991	S	
265	560	C	3	12	0	0	0	1546	P		SILEX	BP2G	0	0	0		1991	S	
266	554	C		1	775	382	1289	1476			SORRENCA	FRAG	0	0	0		1991	S	
266	554	C		2	736	716	1410	1450	P		RMI	BNA	0	0	0	FRAG	1991	S	
266	554	C		3	205	954	0	1460	V		CERAMICA	INFORME	0	0	0	VARIS FRAGS	1991	S	
266	554	C		4	160	957	0	1550	V		CERAMICA	INFORME	0	0	0		1991	S	
266	554	C		5	270	760	0	1603	P		SORRENCA	BNA	0	0	0		1991	S	
266	554	C		6	226	744	0	1614	E		QUARS	BNA	0	0	0	FRAG	1991	S	
266	554	C		7	489	706	0	1658	NE		CALCARIA	BNA	0	0	0		1991	S	
266	554	C		8	495	740	0	1676	NE		QUARS	BNA	0	0	0	FRAG	1991	S	
266	554	C		9	693	834	0	1660	SW		CERAMICA	INFORME	0	0	0		1991	S	
266	554	C		10	755	988	0	1738	P		QUARS	BP	0	0	0		1991	S	
266	554	C		11	854	88	0	1738	P		CERAMICA	INFORME	0	0	0		1991	S	
266	554	C	3	12	845	997	0	1896	P		CERAMICA	INFORME	0	0	0	TOVOT	1991	S	
266	554	C	3	13	719	925	0	1900	S		RMI	BNA	0	0	0	FRAG	1991	S	
266	554	C	3	14	838	942	0	1905	P		CALCARIA	BNA	0	0	0	ALTERAT	1991	S	
266	554	C	3	15	882	857	0	1902	E		RMI	BNA	0	0	0	FRAG ALTERAT	1991	S	
266	554	C	3	16	995	850	0	1888	NE		RMI	BNA	0	0	0	FRAG	1991	S	
266	555	C	2	1	797	346	1327	1367	N		CERAMICA	VORA	0	0	0	MUGRO	1991	S	
266	555	C	3	2	979	27	0	1376			CALCARIA	BNA	0	0	0		1991	S	
266	555	C	3	3	976	115	0	1330			SORRENCA	FRAG	0	0	0		1991	S	
266	555	C	2	4	986	300	0	1330			CALCARIA	COOOL	0	0	0		1991	S	
266	555	C	2	5	892	314	0	1340			QUARS	FRAG	0	0	0		1991	S	
266	555	C	2	7	693	202	0	1340			CONGLOME	FRAG	0	0	0		1991	S	
266	555	C	3	8	356	72	0	1350			CERAMICA	INFORME	0	0	0		1991	S	
266	555	C	3	9	154	66	0	1340			SORRENCA	FRAG	0	0	0		1991	S	
266	555	C	2	10	599	308	0	1340			CERAMICA	INFORME	0	0	0		1991	S	
266	555	C	2	11	598	359	0	1350			QUARS	FRAG	0	0	0		1991	S	

BOBILA MADURELL  
MAS DURAN  
Objectes Coordenats C5  
Campanya 1991

										ALTERACIONS			P D						
c	c	C	N	NUM.	X	Y	Zsup	Zinf	ORIENT	PENDENT	MATERIA	OBJECTE	LONG	AMPL	ESPE	OBSERVACIONS	ANY	U	I
uX	uY	O	I	a	N	V	d	d	J								N	B	T
																			U
266	555	C	2	12	363	347	0	1360			SORRENCA	FRAG	0	0	0		1991		
266	555	C	2	13	659	439	0	1350			QUARS	FRAG	0	0	0		1991		
266	555	C	2	14	781	462	0	1350			SORRENCA	FRAG	0	0	0		1991		
266	555	C	2	15	929	448	0	1330			CERAMICA	INFORME	0	0	0		1991	S	
266	555	C	2	16	562	508	0	1340			CERAMICA	APLICA	0	0	0	MUGRO	1991	S	
266	555	C	2	17	814	544	0	1330			SORRENCA	FRAG	0	0	0		1991		
266	555	C	2	18	877	614	0	1320			CERAMICA	INFORME	0	0	0		1991	S	
266	555	C	2	19	819	633	0	1330			QUARS	FRAG	0	0	0		1991		
266	555	C	2	20	760	757	0	1350			QUARS	FRAG	0	0	0		1991		
266	555	C	2	21	705	770	0	1350			SORRENCA	FRAG	0	0	0		1991		
266	555	C	2	22	839	787	0	1360			CONGLOME	FRAG	0	0	0		1991		
266	555	C	2	23	931	852	0	1340			ESQUIST	BNA	0	0	0		1991	S	
266	555	C	2	24	851	904	0	1340			SILEX	BN1G	0	0	0		1991	S	
266	555	C	2	25	505	912	1350	1370			SORRENCA	BNA	0	0	0	FRAG	1991	S	
266	555	C	2	26	440	455	0	1372			CERAMICA	INFORME	0	0	0		1991	S	
266	555	C	3	27	224	122	0	1384		ME	QUARS	FRAG	0	0	0		1991		
266	555	C	2	28	23	345	0	1387		P	SILEX	BNA	0	0	0		1991	S	
266	555	C	3	29	433	168	0	1401		NW	RMI	BNA	0	0	0	FRAG	1991	S	
266	555	C	2	30	319	448	0	1364		NE	QUARS	BNA	0	0	0		1991	S	
266	555	C	2	31	541	438	0	1365		P	QUARS	BNA	0	0	0	FRAG	1991	S	
266	555	C	2	32	737	261	0	1406		SW	RMI	BNA	0	0	0	FRAG	1991	S	
266	555	C	2	33	930	313	0	1386		NW	SORRENCA	BNA	0	0	0	FRAG	1991	S	
266	555	C	2	34	533	283	0	1344		NW	RMI	BNA	0	0	0	FRAG	1991	S	
266	555	C	2	35	962	431	0	1399		P	CALCARIA	BNA	0	0	0	FRAG	1991	S	
266	555	C	2	36	928	453	0	1375		P	RMI	BNA	0	0	0	FRAG	1991	S	
266	555	C	2	37	832	440	0	1384		P	SORRENCA	BNA	0	0	0		1991	S	
266	555	C	2	38	855	520	0	1388		P	RMI	BNA	0	0	0	FRAG ALTERAT	1991	S	
266	555	C	2	39	754	704	0	1370		P	CERAMICA	INFORME	0	0	0		1991	S	
266	555	C	2	40	956	860	0	1363		E	QUARSITA	BNA	0	0	0	FRAG	1991	S	
266	555	C	2	41	918	860	0	1374		NW	QUARS	BNA	0	0	0	FRAG	1991	S	
266	555	C	2	42	999	836	0	1356		P	RMI	BNA	0	0	0	FRAG	1991	S	
266	555	C	2	43	170	766	0	1368		P	CERAMICA	INFORME	0	0	0		1991	S	
266	555	C	3	44	296	14	0	1420		P	QUARS	BNA	0	0	0		1991	S	
266	555	C	3	45	573	18	0	1435		V	CERAMICA	INFORME	0	0	0		1991	S	
266	555	C	3	46	956	58	0	1430		NW	RMI	BNE	0	0	0	FRAG	1991	S	
266	555	C	2	47	856	227	0	1405		V	CERAMICA	INFORME	0	0	0		1991	S	
266	555	C	2	48	675	240	0	1405		SW	CERAMICA	INFORME	0	0	0		1991		
266	555	C	2	49	296	344	0	1420		SE	SORRENCA	BNA	0	0	0	FRAG	1991	S	
266	555	C	2	50	936	878	0	1420		P	RMI	BNA	0	0	0		1991	S	
266	555	C	2	51	641	833	0	1400		P	CERAMICA	INFORME	0	0	0		1991	S	
266	555	C	2	52	598	810	0	1395		W	CERAMICA	INFORME	0	0	0		1991	S	
266	555	C	2	53	801	758	0	1393		P	CERAMICA	INFORME	0	0	0		1991	S	
266	555	C	2	54	668	575	0	1400		P	CERAMICA	INFORME	0	0	0		1991	S	
266	555	C	2	55	703	563	0	1392		P	CERAMICA	INFORME	0	0	0		1991	S	
266	555	C	2	56	841	715	0	1396		W	RMI	BNA	0	0	0	FRAG	1991	S	
266	555	C	2	57	175	162	0	1425		P	QUARS	BNA	0	0	0		1991	S	
266	555	C	2	58	642	890	0	1406		V	RMI	BNA	0	0	0	FRAG	1991	S	
266	555	C	2	59	376	765	0	1415		P	CERAMICA	APLICA	0	0	0	LLENGUETA	1991	S	
266	555	C	2	60	942	793	0	1420			QUARS	BNA	0	0	0		1991	S	
266	555	C	2	61	407	844	0	1425		P	RMI	BNA	0	0	0		1991	S	

BOBILA MADURELL  
MAS DURAN  
Objectes Coordenats C5  
Campanya 1991

c	c	C	N													ALTERACIONS	P	D	
uX	uY	O	I	NUM.	X	Y	Zsup	Zinf	ORIENT	PENDENT	MATERIA	OBJECTE	LONG	AMPL	ESPE	OBSERVACIONS	ANY	U	I
a	a	N	V															N	B
d	d	J																T	U
266	555	C	2	62	316	848		0	1425	P	QUARSITA	BNA	0	0	0	FRAG	1991	S	
266	555	C	2	63	635	858	1386	1442			CALCARIA	BNA	0	0	0		1991	S	
266	555	C	2	64	178	598		0	1451		CALCARIA	BNA	0	0	0	FRAG ALTERAT	1991	S	
266	555	C	2	65	163	333		0	1452	S	QUARS	BNA	0	0	0		1991	S	
266	555	C	2	66	265	276		0	1438	P	SORRENCA	BNA	0	0	0		1991	S	
266	555	C	2	67	528	486		0	1455	P	RMI	BNA	0	0	0	FRAG	1991	S	
266	555	C	2	68	608	454		0	1446	P	CONGLOME	BNA	0	0	0		1991	S	
266	555	C	2	69	726	384	1388	1472		E	SORRENCA	BNA	0	0	0	ALTERAT	1991	S	
266	555	C	2	70	852	251		0	1450	P	SORRENCA	BNA	0	0	0	ALTERAT	1991	S	
266	555	C	2	71	912	334		0	1431	N	SORRENCA	BNA	0	0	0		1991	S	
266	555	C	2	72	240	741		0	1462	S	SORRENCA	BNA	0	0	0		1991	S	
266	555	C	2	73	63	930		0	1444	P	SORRENCA	BNA	0	0	0	ALTERAT	1991	S	
266	555	C	2	74	845	283		0	1463	W	SORRENCA	BNA	0	0	0	FRAG	1991	S	
266	555	C	2	75	63	930		0	1500	P	RMI	BNA	0	0	0		1991	S	
266	555	C	2	76	979	165		0	1480	NE	CALCARIA	FRAG	0	0	0		1991		
266	555	C	2	77	979	215		0	1480	P	QUARS	FRAG	0	0	0		1991		
266	555	C	2	78	857	390		0	1460	P	SORRENCA	BNA	0	0	0		1991	S	
266	555	C	3	79	259	38		0	1470	V	RMI	BNA	0	0	0		1991	S	
266	555	C	2	80	282	228		0	1490	P	SORRENCA	BNA	0	0	0	FRAG	1991	S	
266	555	C	2	81	910	896		0	1490	P	QUARSITA	BNA	0	0	0		1991	S	
266	555	C	2	82	925	601		0	1460	N	RMI	BNA	0	0	0	FRAG	1991	S	
266	555	C	2	83	940	302		0	1470	P	RMI	BNA	0	0	0	FRAG	1991	S	
266	555	C	2	84	399	903		0	1460	NE	RMI	BNA	0	0	0	FRAG	1991	S	
266	555	C	2	85	499	831		0	1450	NE	QUARS	BNA	0	0	0		1991	S	
266	555	C	3	86	186	18		0	1450	V	CALCARIA	BNA	0	0	0	FRAG	1991	S	
266	555	C	2	87	810	164	1455	1545		E	SORRENCA	BNA	0	0	0		1991	S	
266	555	C	2	88	870	161	1472	1525		E	CALCARIA	CODOLF	0	0	0		1991		
266	555	C	2	89	971	573		0	1510	NE	CERAMICA	INFORME	0	0	0		1991	S	
266	555	C	2	90	654	685	1467	1545		S	SORRENCA	CODOL	0	0	0		1991		
266	555	C	2	91	430	609		0	1520	S	CALCARIA	BNA	0	0	0		1991	S	
266	555	C	2	92	45	676		0	1520		ORGANIC	CARBO	0	0	0		1991	S	
266	555	C	2	93	285	658		0	1554	P	RMI	BNA	0	0	0	FRAG ALTERAT	1991	S	
266	555	C	2	94	45	676		0	1543	P	QUARSITA	BNA	0	0	0	FRAG	1991	S	
266	555	C	2	95	733	599	1515	1589		E	CONGLOME	BNA	0	0	0	MICROCONGL FRAG	1991	S	
266	555	C	2	96	913	505		0	1531	P	RMI	BNA	0	0	0		1991	S	
266	555	C	3	97	177	164		0	1554	P	QUARS	BNA	0	0	0	FRAG	1991	S	
266	555	C	3	98	160	132		0	1551		RMI	BNA	0	0	0	FRAG	1991	S	
266	555	C	3	99	177	164		0	1560	N	RMI	BNA	0	0	0	FRAG	1991	S	
266	555	C	2	100	855	365	1477	1592		NW	RMI	BNA	0	0	0		1991	S	
266	555	C	2	101	77	962		0	1502	S	QUARS	BNA	0	0	0	FRAG	1991	S	
266	555	C	2	102	969	520		0	1558	SW	CERAMICA	INFORME	0	0	0		1991	S	
266	555	C	2	103	689	501		0	1586	S	QUARSITA	BNA	0	0	0	FRAG	1991	S	
266	555	C	2	104	743	374		0	1554	P	CALCARIA	BNA	0	0	0	FRAG ALTERAT	1991	S	
266	555	C	2	105	394	416		0	1585	E	CALCARIA	BNA	0	0	0		1991	S	
266	555	C	3	106	132	132		0	1560		QUARS	BNA	0	0	0	FRAG	1991	S	
266	555	C	2	107	321	208		0	1575	NW	RMI	BNA	0	0	0	FRAG	1991	S	
266	555	C	2	108	636	205		0	1565	N	RMI	BNA	0	0	0	ALTERAT	1991	S	
266	555	C	2	109	742	168		0	1562	N	CERAMICA	APLICA	0	0	0	MUGRO	1991	S	
266	555	C	3	110	227	100		0	1585	P	QUARS	BNA	0	0	0	FRAG	1991	S	
266	555	C	3	111	89	259		0	1614	E	CERAMICA	INFORME	0	0	0		1991		

BOBILA MADURELL  
MAS DURAN  
Objectes Coordinats C5  
Campanya 1991

		c c C N												ALTERACIONS				P D	
uX	uY	O	I	NUM.	X	Y	Zsup	Zinf	ORIENT	PENDENT	MATERIA	OBJECTE	LONG	AMPL	ESPE	OBSERVACIONS	ANY	U I	
a	a	a	N	V														N B	
d	d	J																	T U
266	555	C	2	112	253	275	0	1634	E		QUARS	BNA	0	0	0	FRAG	1991	S	
266	555	C	2	113	863	254	0	1600	W		QUARS	BNA	0	0	0	FRAG	1991	S	
266	555	C	2	114	865	578	0	1627	P		INDET	BNA	0	0	0		1991	S	
266	555	C	2	115	969	645	0	1606	NW		RMI	BNA	0	0	0		1991	S	
266	555	C	2	116	66	891	0	1618			OS	INDET	0	0	0		1991	S	
266	555	C	3	117	129	87	0	1639	N		RMI	BNA	0	0	0	FRAG	1991	S	
266	555	C	3	118	56	203	0	1649	SE		CALCARIA	BNA	0	0	0	ALTERAT	1991	S	
266	555	C	2	119	353	260	1552	1653	P		GRANIT	BNA	0	0	0	FRAG	1991	S	
266	555	C	2	120	682	213	0	1625	P		SORRENCA	BNA	0	0	0	FRAG	1991	S	
266	555	C	2	121	553	331	0	1654	N		RMI	BNA	0	0	0	ALTERAT	1991	S	
266	555	C	2	122	552	382	0	1658	SE		SORRENCA	BNA	0	0	0	FRAG BNE?	1991	S	
266	555	C	2	123	635	420	0	1663	SE		CERAMICA	INFORME	0	0	0		1991	S	
266	555	C	2	124	979	580	0	1635	NE		RMI	BNA	0	0	0	FRAG	1991	S	
266	555	C	2	125	500	660	0	1660	P		QUARS	BNA	0	0	0		1991	S	
266	555	C	2	126	423	807	0	1655	P		CALCARIA	BNA	0	0	0	FRAC	1991	S	
266	555	C	2	127	337	813	0	1685	SW		RMI	BNA	0	0	0		1991	S	
266	555	C	2	128	475	220	0	1684	NE		RMI	BNA	0	0	0	FRAG	1991	S	
266	555	C	2	129	516	156	0	1676	N		RMI	BNA	0	0	0	FRAG ALTERAT	1991	S	
266	555	C	3	130	556	36	0	1655	P		SORRENCA	BNA	0	0	0	FRAG	1991	S	
266	555	C	2	131	784	350	0	1675	P		SORRENCA	BNA	0	0	0	FRAC	1991	S	
266	555	C	2	132	528	283	0	1665	P		CERAMICA	INFORME	0	0	0		1991	S	
266	555	C	2	133	743	353	0	1666	S		CERAMICA	INFORME	0	0	0		1991	S	
266	555	C	3	134	528	283	0	1700	W		CERAMICA	PANXA	0	0	0		1991	S	
266	555	C	3	135	199	143	0	1672	V		CERAMICA	INFORME	0	0	0		1991	S	
266	555	C	3	136	278	54	0	1668	P		CERAMICA	INFORME	0	0	0		1991	S	
266	555	C	3	137	752	32	0	1658	P		ESQUIST	BNA	0	0	0		1991	S	
266	555	C	3	138	650	348	0	1680	P		QUARSITA	BNA	0	0	0	FRAG	1991	S	
266	555	C	3	139	881	375	0	1683	S		RMI	BNA	0	0	0		1991	S	
266	555	C	3	140	855	245	0	1685	V		SORRENCA	BNA	0	0	0		1991	S	
266	555	C	3	141	918	313	0	1680	NE		CALCARIA	BNA	0	0	0		1991	S	
266	555	C	3	142	432	5	0	1669	P		CERAMICA	INFORME	0	0	0		1991	S	
266	555	C	3	143	939	423	0	1694	S		CERAMICA	INFORME	0	0	0		1991	S	
266	555	C	3	144	864	782	0	1760	S		CERAMICA	INFORME	0	0	0		1991	S	
266	555	C	3	145	810	522	0	1728	NW		PISSARRA	BNA	0	0	0	FRAG	1991	S	
266	555	C	3	146	864	782	0	1695	NE		CERAMICA	VORA	0	0	0		1991	S	
266	555	C	3	147	810	522	0	1669	N		CERAMICA	INFORME	0	0	0		1991	S	
266	555	C	3	148	73	156	0	1725	V		QUARSITA	BNA	0	0	0		1991	S	
266	555	C	3	149	349	334	0	1765	S		CERAMICA	APLICA	0	0	0	LLENGUETA	1991	S	
266	555	C	2	150	79	747	0	1776	SE		QUARSITA	BNA	0	0	0	FRAG	1991	S	
266	555	C	3	151	579	460	0	1770	S		RMI	BNA	0	0	0	FRAG	1991	S	
266	555	C	3	152	605	409	0	1743	P		CONGLOME	BNA	0	0	0	MICROCONGL FRAG	1991	S	
266	555	C	3	153	190	148	0	1839	SE		RMI	BNA	0	0	0	FRAG	1991	S	
266	555	C	3	154	374	104	0	1768	E		CERAMICA	INFORME	0	0	0		1991	S	
266	555	C	3	155	350	285	0	1795	V		SORRENCA	BNA	0	0	0		1991	S	
266	555	C	3	156	559	311	0	1810	V		QUARS	BNA	0	0	0	FRAG	1991	S	
121	266	555	C	3	157	912	745	0	1836	S		RMI	BNA	0	0	0	FRAG	1991	S
266	555	C	3	158	402	948	0	1783	E		CERAMICA	VORA	0	0	0	MOLTS FRAGS	1991	S	
266	555	C	3	159	503	928	0	1778	P		CERAMICA	INFORME	0	0	0	FRAG	1991	S	
266	555	C	3	160	698	846	0	1824	S		CERAMICA	INFORME	0	0	0		1991	S	
266	555	C	3	161	916	841	0	1846	SE		RMI	BNA	0	0	0	FRAG	1991	S	

BOBILA MADURELL  
MAS DURAN  
Objectes Coordenats C5  
Campanya 1991

c	c	C	N	NUM.	X	Y	Zsup	Zinf	ORIENT	PENDENT	MATERIA	OBJECTE	LONG	AMPL	ESPE	ALTERACIONS	OBSERVACIONS	P	D
uX	uY	O	I															ANY	U
a	a	N	V																I
d	d	J																	N
																			B
																			T
																			U
266	555	C	3	162	773	982	0	1963	V		RMI	BNA	0	0	0	FRAG		1991	S
266	555	C	3	163	828	989	0	1932	V		RMI	BNA	0	0	0	FRAG		1991	S
266	555	C	3	164	930	993	0	1910	NE		CALCARIA	BNA	0	0	0	ALTERAT		1991	S
266	555	C	3	165	757	929	0	1924	NE		RMI	BNA	0	0	0	FRAG ALTERAT		1991	S
266	555	C	3	166	840	937	0	1942	NE		RMI	BNA	0	0	0	FRAG ALTERAT		1991	S
266	555	C	3	167	879	943	0	1951	SW		CALCARIA	BNA	0	0	0	FRAG ALTERAT		1991	S
266	555	C	3	168	991	377	0	1874	P		CALCARIA	BNA	0	0	0	FRAG ALTERAT		1991	S
266	555	C	3	169	823	546	0	1914	E		RMI	BNA	0	0	0	FRAG		1991	S
266	555	C	3	170	970	607	0	1953	SE		RMI	BNA	0	0	0	FRAG ALTERAT		1991	S
266	555	C	3	171	749	714	0	1922	N		CONGLOME	BNA	0	0	0	ALTERAT		1991	S
266	555	C	3	172	833	760	0	1931	V		RMI	BNA	0	0	0	FRAG ALTERAT		1991	S
266	555	C	3	173	984	766	0	1927	V		RMI	BNA	0	0	0	FRAG ALTERAT		1991	S
266	555	C	3	174	830	853	0	1964	SW		RMI	BNA	0	0	0	FRAG ALTERAT		1991	S
266	555	C	3	175	805	802	0	1971	SE		RMI	BNA	0	0	0	FRAG		1991	S
266	555	C	3	176	898	832	0	1982	SW		RMI	BNA	0	0	0	ALTERAT		1991	S
266	555	C	3	177	954	831	0	1988	V		RMI	BNA	0	0	0	FRAG ALTERAT		1991	S
266	555	C	3	178	978	777	0	1965	NW		RMI	BNA	0	0	0	FRAG ALTERAT		1991	S
266	556	C	2	1	429	212	0	1350			CALCARIA	BNA	0	0	0			1991	S
266	556	C	2	2	912	745	0	1350			RMI	BNA	0	0	0			1991	S
266	556	C	2	3	439	431	0	1350			CERAMICA	APLICA	0	0	0	LLENGETES		1991	S
266	556	C	2	4	548	313	0	1330			RMI	BNA	0	0	0	FRAG		1991	S
266	556	C	2	5	653	217	0	1340			SORRENCA	BNA	0	0	0	FRAG		1991	S
266	556	C	2	6	715	415	0	1330			INDET	BNA	0	0	0	FRAG		1991	S
266	556	C	2	7	962	311	0	1320			SORRENCA	FRAG	0	0	0			1991	S
266	556	C	2	8	333	713	0	1360			CERAMICA	INFORME	0	0	0			1991	S
266	556	C	2	9	665	788	0	1340			CERAMICA	APLICA	0	0	0	LLENGUETA MUGRO		1991	S
266	556	C	2	10	941	133	0	1360	S		CONGLOME	FRAG	0	0	0			1991	S
266	556	C	2	11	912	315	0	1345	S		CERAMICA	INFORME	0	0	0			1991	S
266	556	C	2	12	955	431	0	1350	N		RMI	BNA	0	0	0	FRAG		1991	S
266	556	C	2	13	474	538	0	1355	SW		CERAMICA	VORA	0	0	0			1991	S
266	556	C	2	14	609	536	0	1365	P		CERAMICA	INFORME	0	0	0			1991	S
266	556	C	2	15	184	209	0	1365			ORGANIC	MOLUSC	0	0	0			1991	S
266	556	C	2	16	223	192	0	1370			ORGANIC	MOLUSC	0	0	0			1991	S
266	556	C	2	17	328	180	0	1380	N		QUARS	BNA	0	0	0	FRAG		1991	S
266	556	C	2	18	385	651	0	1370	N		CERAMICA	VORA	0	0	0			1991	S
266	556	C	2	19	732	33	0	1400	SE		CALCARIA	BNA	0	0	0	FRAG ALTERAT		1991	S
266	556	C	2	20	626	146	0	1380	S		QUARS	BNA	0	0	0	FRAG		1991	S
266	556	C	2	21	267	483	0	1385	NW		RMI	BNA	0	0	0	FRAG		1991	S
266	556	C	2	22	164	826	0	1390	P		CERAMICA	INFORME	0	0	0			1991	S
266	556	C	2	23	143	868	0	1400	P		CERAMICA	INFORME	0	0	0			1991	S
266	556	C	2	24	431	934	0	1370	S		CERAMICA	INFORME	0	0	0			1991	S
266	556	C	2	25	435	204	0	1385	SE		QUARS	BPI	0	0	0			1991	S
266	556	C	2	26	947	864	0	1365	P		SILEX	BPF	0	0	0			1991	S
266	556	C	2	27	982	198	0	1380	S		RMI	BNA	0	0	0			1991	S
266	556	C	2	28	414	243	0	1410	NE-SW	SW	RMI	BNA	0	0	0	FRAG		1991	S
266	556	C	2	29	128	596	0	1400	NW-SE	NW	CERAMICA	CARENA	0	0	0			1991	S
266	556	C	2	30	944	524	0	1405	NE-SW	S	QUARS	BNA	0	0	0			1991	S
266	556	C	2	31	389	952	0	1385	NE-SW	SW	CERAMICA	INFORME	0	0	0			1991	S
266	556	C	2	32	493	43	0	1435	NW-SE	N	CALCARIA	BP	0	0	0			1991	S
266	556	C	2	34	142	389	0	1445	NE-SW	N	CALCARIA	BNA	0	0	0	FRAG ALTERAT		1991	S

BOBILA MADURELL  
MAS DURAN  
Objectes Coordenats C5  
Campanya 1991

c	c	C	N											ALTERACIONS	P	D			
uX	uY	O	I	NUM.	X	Y	Zsup	Zinf	ORIENT	PENDENT	MATERIA	OBJECTE	LONG	AMPL	ESPE	OBSERVACIONS	ANY	U	I
a	a	N	V															N	B
d	d	J																T	U
266	556	C	2	35	739	443	0	1440	N-S	P	CERAMICA	INFORME	0	0	0		1991	S	
266	556	C	2	36	291	786	0	1405	E-W	N	CALCARIA	BNA	0	0	0	ALTERAT	1991	S	
266	556	C	2	37	710	947	0	1410	NE-SW	SW	QUARS	BNA	0	0	0	FRAG	1991	S	
266	556	C	2	38	800	949	0	1430		S	CALCARIA	FRAG	0	0	0		1991		
266	556	C	2	39	53	962	0	1420	N-S	P	CERAMICA	INFORME	0	0	0		1991	S	
266	556	C	2	40	188	678	0	1465	N-S	N	QUARS	BNA	0	0	0	FRAG	1991	S	
266	556	C	2	41	432	741	0	1435	E-W	W	RMI	BNA	0	0	0	FRAG	1991	S	
266	556	C	2	42	238	60	0	1475	NW-SE	SE	RMI	BNA	0	0	0	FRAG	1991	S	
266	556	C	2	43	306	98	0	1465	NW-SE	SE	RMI	BNA	0	0	0	FRAG	1991	S	
266	556	C	2	44	737	251	0	1453	E-W	W	CALCARIA	BNA	0	0	0	FRAG	1991	S	
266	556	C	2	45	450	192	0	1460	NE-SW		QUARS	BNA	0	0	0		1991	S	
266	556	C	2	46	95	422	0	1455	NE-SW	SE	RMI	BNA	0	0	0	FRAG	1991	S	
266	556	C	2	47	204	338	0	1460	NW-SE		CONGLOME	BNA	0	0	0		1991	S	
266	556	C	2	48	567	452	0	1450	N-S	P	CERAMICA	INFORME	0	0	0		1991	S	
266	556	C	2	49	196	818	0	1460	NE-SW	E	QUARS	BNA	0	0	0	FRAG	1991	S	
266	556	C	2	50	648	656	0	1472			ORGANIC	CARBO	0	0	0		1991	S	
266	556	C	2	51	398	575	0	1496		P	QUARS	BPI	0	0	0		1991	S	
266	556	C	2	52	553	703	0	1491		V	QUARS	BNA	0	0	0	FRAG	1991	S	
266	556	C	2	53	749	732	0	1524		P	RMI	BNA	0	0	0	FRAG	1991	S	
266	556	C	2	54	240	895	0	1532		NW	ESQUIST	BNA	0	0	0		1991	S	
266	556	C	2	55	136	803	0	1505		N	RMI	BNA	0	0	0	FRAG	1991	S	
266	556	C	2	56	435	109	0	1536		W	QUARS	BNA	0	0	0	FRAG	1991	S	
266	556	C	2	57	300	121	1443	1542		P	RMI	BNA	0	0	0		1991	S	
266	556	C	2	58	385	244	1486	1550		SE	RMI	BNA	0	0	0		1991	S	
266	556	C	2	59	501	38	0	1537		E	CONGLOME	BNA	0	0	0		1991	S	
266	556	C	2	60	615	501	0	1524		SE	RMI	BNA	0	0	0	FRAG	1991	S	
266	556	C	2	61	639	592	1475	1525		P	RMI	BNA	0	0	0	FRAG	1991	S	
266	556	C	2	62	814	972	0	1524		S	CONGLOME	BNA	0	0	0	FRAG	1991	S	
266	556	C	2	63	751	397	0	1558		SE	SORRENCA	FRAG	0	0	0	NO RECUPERAT	1991	S	
266	556	C	2	64	400	27	1520	1590		E	RMI	BNA	0	0	0	FRAG	1991	S	
266	556	C	2	65	603	210	0	1582		N	CALCARIA	BNA	0	0	0	FRAG ALTERAT	1991	S	
266	556	C	2	66	400	27	0	1643		P	OS	INDET	0	0	0		1991	S	
266	556	C	2	67	603	210	0	1670		P	CERAMICA	INFORME	0	0	0		1991	S	
266	556	C	2	68	625	911	0	1680			ORGANIC	CARBO	0	0	0		1991	S	
266	556	C	2	69	408	848	0	1683		P	CERAMICA	INFORME	0	0	0		1991	S	
266	556	C	2	70	79	961	0	1706		N	SORRENCA	BNA	0	0	0		1991	S	
266	556	C	2	71	24	900	0	1727		V	CONGLOME	BNA	0	0	0	FRAG MICROCONGL	1991	S	
266	556	C	2	72	765	202	0	1652		S	ESQUIST	BNA	0	0	0	FRAG	1991	S	
266	556	C	2	73	770	19	0	1655		V	CERAMICA	INFORME	0	0	0	ARGILA CUITA	1991	S	
266	556	C	2	74	107	757	0	1724		W	RMI	BNA	0	0	0	FRAG	1991	S	
266	556	C	3	75	549	15	0	1724		P	SORRENCA	BNA	0	0	0	FRAG	1991	S	
266	556	C	3	76	438	394	0	1720		S	CERAMICA	INFORME	0	0	0	ARGILA CUITA	1991	S	
266	556	C	3	77	98	816	0	1730		S	CERAMICA	INFORME	0	0	0		1991	S	
266	556	C	3	78	483	821	0	1698		P	CERAMICA	INFORME	0	0	0		1991	S	
266	556	C	3	79	543	747	0	1709		N	CERAMICA	INFORME	0	0	0		1991	S	
266	556	C	3	80	147	971	0	1740		N	CERAMICA	INFORME	0	0	0		1991	S	
266	556	C	3	81	373	909	0	1730		W	SORRENCA	BNA	0	0	0	FRAG	1991	S	
266	556	C	3	82	341	653	0	1783		P	OS	DET	0	0	0	EI	1991	S	
266	556	C	3	83	538	143	0	1729		P	ORGANIC	CARBO	0	0	0		1991	S	
266	556	C	3	84	334	709	0	1726		P	OS	DET	0	0	0	EI	1991	S	

BOBILA MADURELL  
MAS DURAN  
Objectes Coordenats C5  
Campanya 1991

c	c	C	N										ALTERACIONS	P	D				
uX	uY	O	I	NUM.	X	Y	Zsup	Zinf	ORIENT	PENDENT	MATERIA	OBJECTE	LONG	AMPL	ESPE	OBSERVACIONS	ANY	U	I
a	a	N	V															N	B
d	d	J																T	U
266	556	C	3	85	309	649	0	1734	W		OS	DET	0	0	0		1991	S	
266	556	C	3	86	324	585	0	1750	NW		OS	DET	0	0	0		1991	S	
266	556	C	3	87	710	11	0	1632	W		ESQUIST	BNA	0	0	0	FRAG	1991	S	
266	556	C	3	88	871	83	0	1729	V		CONGLOME	BNA	0	0	0	MICROCONGL	FRAG	1991	S
266	556	C	3	89	245	910	0	1777	S		OS	INDET	0	0	0	VARIS FRAGS	1991	S	
266	556	C	3	90	214	946	0	1781	NE		RMI	BNA	0	0	0	FRAG	1991	S	
266	556	C	3	91	161	953	0	1772	S		ESQUIST	BNA	0	0	0	FRAG	1991	S	
266	556	C	3	92	184	989	0	1756	S		QUARS	BNA	0	0	0	FRAG	1991	S	
266	556	C	3	93	777	196	1568	1727	S		CALCARIA	BNA	0	0	0	FRAG	1991	S	
266	556	C	3	94	66	805	0	1791	P		CERAMICA	INFORME	0	0	0	2 FRAGS	1991	S	
266	556	C	3	95	102	710	0	1789	P		CERAMICA	VORA	0	0	0	4 FRAGS	1991	S	
266	556	C	3	96	179	670	0	1794	P		RMI	BNA	0	0	0	FRAG	1991	S	
266	556	C	3	97	107	244	0	1804	W		QUARSITA	BNA	0	0	0		1991	S	
266	556	C	3	98	309	332	0	0	P		ORGANIC	CARBO	0	0	0		1991	S	
266	556	C	3	99	78	643	0	1810	S		OS	INDET	0	0	0		1991	S	
266	556	C	3	100	93	752	0	1820	S		CERAMICA	INFORME	0	0	0		1991	S	
266	556	C	3	101	123	732	0	1822	W		CERAMICA	INFORME	0	0	0		1991	S	
266	556	C	3	102	53	659	0	1837	P		QUARS	BNA	0	0	0	FRAG	1991	S	
266	556	C	3	103	198	495	0	1834	W		CERAMICA	INFORME	0	0	0		1991	S	
266	556	C	3	104	613	612	0	1839	N		CERAMICA	VORA	0	0	0		1991	S	
266	556	C	3	105	994	124	0	1794	W		RMI	BPF	0	0	0		1991	S	
266	556	C	3	106	803	10	0	1797	S		RMI	BPF	0	0	0		1991	S	
266	556	C	3	107	162	714	0	1830	E		CERAMICA	INFORME	0	0	0		1991	S	
266	556	C	3	108	119	482	0	1831	SW		CERAMICA	INFORME	0	0	0		1991	S	
266	556	C	3	109	45	172	0	1866	W		CERAMICA	INFORME	0	0	0		1991	S	
266	556	C	3	110	20	805	0	1854	E		CERAMICA	INFORME	0	0	0		1991	S	
266	556	C	3	111	0	0	1763	1902	SW		CONGLOME	BNA	0	0	0	MICROCONGLOME	1991	S	
266	556	C	3	112	972	103	0	1921	SE		CALCARIA	BNA	0	0	0	FRAG ALTERAT	1991	S	
266	556	C	3	113	938	37	0	1919	NE		RMI	BNA	0	0	0	FRAG	1991	S	
266	556	C	3	114	927	57	0	1935	V		RMI	BNA	0	0	0	FRAG	1991	S	
266	556	C	3	115	966	58	0	1956	SE		CALCARIA	BNA	0	0	0	FRAG ALTERAT	1991	S	
266	556	C	3	116	600	225	0	1829	N		QUARS	BNA	0	0	0		1991	S	
266	556	C	3	117	519	333	0	1849	E		QUARS	BNA	0	0	0	FRAG	1991	S	
266	556	C	3	118	421	560	0	1846	P		CONGLOME	BNA	0	0	0	FRAG MICROCONGL	1991	S	
266	556	C	3	119	695	912	0	1898	W		RMI	BNA	0	0	0	FRAG	1991	S	
266	557	C		1	949	243	0	1315			CALCARIA	BNA	0	0	0	ALTERAT	1991	S	
266	557	C		2	543	591	0	1225			QUARSITA	BP	0	0	0		1991	S	
266	557	C		3	502	671	0	1267			RMI	BNA	0	0	0		1991	S	
266	557	C		4	494	932	0	1150			QUARS	BNA	0	0	0	FRAG	1991	S	
266	557	C		5	926	411	0	1307			RMI	BNA	0	0	0	FRAG	1991	S	
266	557	C		6	924	265	0	1302			SILEX	BPF	0	0	0	LAMINA	1991	S	
266	557	C		7	882	771	0	1283	P		RMI	BNA	0	0	0	FRAG	1991	S	
266	557	C		8	868	960	0	1268	W		QUARSITA	BNA	0	0	0	FRAG	1991	S	
266	557	C		9	655	976	0	1268	S		CALCARIA	BNA	0	0	0	3 FRAGS	1991	S	
266	557	C		10	862	146	0	1317	P		CERAMICA	INFORME	0	0	0		1991	S	
266	557	C		11	79	889	0	1298	SW		CERAMICA	INFORME	0	0	0		1991	S	
266	557	C		12	582	453	0	1330	S		OS	INDET	0	0	0		1991	S	
266	557	C	2	13	358	233	0	1381	N-S	P	SORRENCA	BNA	0	0	0		1991	S	
266	557	C	2	14	582	453	0	1380	N-S	P	CERAMICA	INFORME	0	0	0		1991	S	
266	557	C	2	15	364	674	0	1384	N-S	E	SORRENCA	BNA	0	0	0	FRAG	1991	S	

01/28/92

BOBILA MADURELL  
MAS DURAN  
Objectes Coordenats C5  
Campanya 1991

c	c	C	N										ALTERACIONS	P	D									
uX	uY	O	I	NUM.	X	Y	Zsup	Zinf	ORIENT	PENDENT	MATERIA	OBJECTE	LONG	AMPL	ESPE	OBSERVACIONS	ANY	U	I	N	B	T	U	
a	a	N	V																					
d	d	J																						
266	557	C	2	16	875	445	0	1371	NE-SW	SE	QUARS	BPI	0	0	0		1991	S						
266	557	C	2	17	606	693	0	1374	NE-SW	P	SORRENCA	BNA	0	0	0		1991	S						
266	557	C	2	18	425	761	0	1370	N-S	W	SORRENCA	BNA	0	0	0	FRAG	1991	S						
266	557	C	2	19	703	775	0	1318	NW-SE	NW	RMI	BNA	0	0	0	FRAG	1991	S						
266	557	C	2	20	757	744	0	1330	NW-SE	NW	CERAMICA	INFORME	0	0	0		1991	S						
266	557	C	2	21	414	964	0	1357	E-W	NW	CALCARIA	BNA	0	0	0	FRAG	1991	S						
266	557	C	2	22	562	471	0	1375	N-S	P	CERAMICA	INFORME	0	0	0		1991	S						
266	557	C	2	23	557	550	0	1377	N-S	P	CERAMICA	VORA	0	0	0		1991	S						
266	557	C	2	24	445	696	0	1361		P	QUARS	BNA	0	0	0	FRAG	1991	S						
266	557	C	2	25	495	410	1346	1377		P	CALCARIA	BNA	0	0	0	FRAC	1991	S						
266	557	C	2	26	262	114	0	1387		P	CERAMICA	INFORME	0	0	0		1991	S						
266	557	C	2	27	375	737	0	1365		P	CERAMICA	INFORME	0	0	0		1991	S						
266	557	C	2	28	845	274	0	1388		NW	RMI	BNA	0	0	0		1991	S						
266	557	C	2	29	884	231	0	1370		NW	QUARS	BNA	0	0	0	FRAG	1991	S						
266	557	C	2	30	971	260	0	1386		N	RMI	BNA	0	0	0	FRAG	1991	S						
266	557	C	2	31	984	166	0	1370		P	RMI	BNA	0	0	0		1991	S						
266	557	C	2	32	944	320	0	1380		N	QUARS	BNA	0	0	0	FRAG	1991	S						
266	557	C	2	33	781	488	0	1400		SW	SORRENCA	BNA	0	0	0	FRAG	1991	S						
266	557	C	2	34	899	566	0	1380		P	SORRENCA	BNA	0	0	0	FRAG	1991	S						
266	557	C	2	35	757	641	0	1401		W	SORRENCA	BNA	0	0	0	FRAG	1991	S						
266	557	C	2	36	692	785	0	1366		P	QUARS	BNA	0	0	0	FRAG	1991	S						
266	557	C	2	37	566	820	0	1366		W	SORRENCA	BNA	0	0	0	FRAG ALTERAT	1991	S						
266	557	C	2	38	469	552	0	1400		NW	SORRENCA	BNE	0	0	0		1991	S						
266	557	C	2	39	528	581	0	1383		SE	CERAMICA	INFORME	0	0	0	2 FRAGS	1991	S						
266	557	C	2	40	273	184	0	1408		SE	QUARS	BNA	0	0	0	FRAG	1991	S						
266	557	C	2	41	260	377	0	1398		P	QUARS	BNA	0	0	0	FRAG	1991	S						
266	557	C	2	42	394	43	0	1380		V	INDET	BNA	0	0	0	FRAG	1991	S						
266	557	C	2	43	370	203	0	1409		P	QUARS	BNA	0	0	0	FRAG	1991	S						
266	557	C	2	44	570	212	0	1405		NW	SORRENCA	BNA	0	0	0	FRAG ALTERAT	1991	S						
266	557	C	2	45	701	219	0	1397		V	SORRENCA	BNA	0	0	0	FRAG	1991	S						
266	557	C	2	46	696	478	0	1381		P	CERAMICA	INFORME	0	0	0		1991	S						
266	557	C	2	47	881	167	0	1390		E	CERAMICA	INFORME	0	0	0		1991	S						
266	557	C	2	48	942	139	0	1390		SE	CERAMICA	INFORME	0	0	0	VARIS FRAGS	1991	S						
266	557	C	2	49	868	258	0	1402		E	CONGLOME	BNA	0	0	0	FRAG MICROCONGL	1991	S						
266	557	C	2	50	806	271	0	1389		P	RMI	BNA	0	0	0	FRAG	1991	S						
266	557	C	2	51	865	372	0	1389		N	CALCARIA	BPF	0	0	0		1991	S						
266	557	C	2	52	980	408	0	1392		NE	QUARS	BNA	0	0	0	FRAG	1991	S						
266	557	C	2	53	540	350	0	1406		V	CALCARIA	BP	0	0	0		1991	S						
266	557	C	2	54	553	323	0	1386		P	OS	INDET	0	0	0		1991	S						
266	557	C	2	55	431	704	0	1393		W	QUARS	CODOLF	0	0	0		1991	S						
266	557	C	2	56	709	975	0	1385		V	CONGLOME	BNA	0	0	0	MICROCONGLOME	1991	S						
266	557	C	2	57	998	952	0	1351		V	SORRENCA	BNA	0	0	0	FRAG ALTERAT	1991	S						
266	557	C	2	58	934	832	0	1379		P	CERAMICA	INFORME	0	0	0	VARIS FRAGS	1991	S						
266	557	C	2	60	435	152	0	1437		SW	CONGLOME	BNA	0	0	0	FRAG MICROCONGL	1991	S						
266	557	C	2	61	740	359	0	1443		S	CERAMICA	VORA	0	0	0	TRENCAT	1991	S						
266	557	C	2	62	692	405	0	1424		W	QUARS	BNA	0	0	0	FRAG	1991	S						
266	557	C	2	63	494	470	0	1421		P	QUARS	BPF	0	0	0		1991	S						
266	557	C	2	65	684	544	0	1425		E	RMI	BNA	0	0	0		1991	S						
266	557	C	2	67	431	539	0	1417		S	CERAMICA	INFORME	0	0	0	2 FRAGS	1991	S						
266	557	C	2	68	770	597	0	1435		S	CALCARIA	BNA	0	0	0	NO RECUPERAT	1991	S						

125



BOBILA MADURELL  
MAS DURAN  
Objectes Coordinats C5  
Campanya 1991

c	c	C	N	NUM.	X	Y	Zsup	Zinf	ORIENT	PENDENT	MATERIA	OBJECTE	LONG	AMPL	ESPE	ALTERACIONS	OBSERVACIONS	P	D
uX	uY	O	I															ANY	U
a	a	N	V															N	B
d	d	J																T	U
266	557	C	2	69	422	614	0	1415	P		CALCARIA	BPI	0	0	0			1991	S
266	557	C	2	70	782	656	0	1416	SW		QUARSITA	BPI	0	0	0			1991	S
266	557	C	2	71	861	610	0	1416	E		RMI	BNA	0	0	0	FRAG		1991	S
266	557	C	2	72	702	765	0	1415	NE		CERAMICA	INFORME	0	0	0			1991	S
266	557	C	2	73	857	718	0	1405	S		SORRENCA	BNA	0	0	0	FRAG		1991	S
266	557	C	2	74	87	584	0	1385	SW		QUARS	BNA	0	0	0	FRAG		1991	S
266	557	C	2	75	808	122	0	1427	SW		ORGANIC	CARBO	0	0	0			1991	S
266	557	C	2	76	917	516	0	1425	P		QUARS	BNA	0	0	0	FRAG		1991	S
266	557	C	2	77	786	506	0	1445			INDET	BNA	0	0	0	FRAG		1991	S
266	557	C	2	78	806	752	0	1422	S		CONGLOME	BNA	0	0	0	FRAG MICROCONGL		1991	S
266	557	C	2	79	424	725	0	1422	N		CALCARIA	BNA	0	0	0	FRAG NO RECUPER		1991	S
266	557	C	2	80	328	441	0	1423	P		CALCARIA	BNA	0	0	0	NO RECUPERAT		1991	S
266	557	C	2	81	861	849	0	1417	P		CERAMICA	INFORME	0	0	0			1991	S
266	557	C	2	82	397	758	0	1431	N		QUARSITA	BNA	0	0	0	FRAC		1991	S
266	557	C	2	83	35	341	0	1438			CERAMICA	INFORME	0	0	0			1991	S
266	557	C	2	84	47	329	0	1433			ORGANIC	MOLUSC	0	0	0			1991	
266	557	C	2	85	80	505	0	1434	NW		SORRENCA	BNA	0	0	0	FRAG		1991	S
266	557	C	2	86	91	531	0	1447	W		CERAMICA	INFORME	0	0	0			1991	S
266	557	C	2	87	110	497	0	1453	NW		CALCARIA	BNA	0	0	0	FRAG		1991	S
266	557	C	2	88	107	47	0	1440	NE		RMI	BNA	0	0	0	FRAG		1991	S
266	557	C	2	89	343	707	0	1474	N		CERAMICA	INFORME	0	0	0			1991	S
266	557	C	2	90	1	111	1382	1498	W		SORRENCA	BNA	0	0	0	FRAG		1991	S
266	557	C	2	91	112	1	0	1495	S		QUARS	BNA	0	0	0	FRAG		1991	S
266	557	C	2	92	154	716	0	1487	P		QUARS	BNA	0	0	0	FRAG		1991	S
266	557	C	2	93	818	782	0	1529	P		SORRENCA	BNA	0	0	0	FRAG NO RECUPER		1991	S
266	557	C	2	94	744	416	0	1520	NW		SORRENCA	BNA	0	0	0	FRAG		1991	S
266	557	C	2	95	818	782	0	1526	N		CALCARIA	BNA	0	0	0	FRAC		1991	S
266	557	C	2	96	744	416	0	1515	N		INDET	BNA	0	0	0	ESCORIA?		1991	S
266	557	C	2	97	750	365	0	1524	N		SORRENCA	BNA	0	0	0	FRAG		1991	S
266	557	C	2	98	831	359	0	1538	P		SORRENCA	BNA	0	0	0	FRAG		1991	S
266	557	C	2	99	692	326	0	1554	W		SORRENCA	BNA	0	0	0	FRAG		1991	S
266	557	C	2	100	488	394	0	1539	W		SORRENCA	BNA	0	0	0	FRAG ALTERAT		1991	S
266	557	C	2	101	550	314	0	1547	E		SORRENCA	BNA	0	0	0	FRAG		1991	S
266	557	C	2	102	611	272	0	1541	W		CALCARIA	BNA	0	0	0	FRAG CREMAT		1991	S
266	557	C	2	103	467	214	0	1578	SW		CERAMICA	APLICA	0	0	0	2 MUGRONS VORA		1991	S
266	557	C	2	104	760	676	0	1542	E		SORRENCA	BNA	0	0	0	FRAG NO RECUPER		1991	S
266	557	C	2	105	945	574	0	1564	S		CERAMICA	INFORME	0	0	0			1991	S
266	557	C	2	106	755	667	0	1576	NW		CONGLOME	BNA	0	0	0	FRAG MICROCONGL		1991	S
266	557	C	2	107	763	599	0	1587	W		CONGLOME	BNA	0	0	0	FRAG MICROCONGL		1991	S
266	557	C	2	108	797	518	0	1559	N		GRANIT	BNA	0	0	0			1991	S
266	557	C	2	109	617	574	0	1590	W		INDET	BNA	0	0	0	FRAC		1991	S
266	557	C	2	110	708	452	0	1573	N		QUARS	BNA	0	0	0			1991	S
266	557	C	2	111	511	532	0	1581	P		RMI	BNA	0	0	0	FRAG		1991	S
266	557	C	2	112	498	415	0	1583	W		CONGLOME	BNA	0	0	0	FRAG MICROCONGL		1991	S
266	557	C	2	113	614	421	0	1585	SW		RMI	BNA	0	0	0	FRAG		1991	S
266	557	C	2	114	683	385	0	1559	NW		SORRENCA	BNA	0	0	0	FRAG		1991	S
266	557	C	2	115	635	336	0	1556	W		RMI	BNA	0	0	0			1991	S
266	557	C	2	116	608	281	0	1554	P		RMI	BNA	0	0	0	FRAG		1991	S
266	557	C	2	117	554	310	0	1570	N		CALCARIA	BNA	0	0	0	FRAG		1991	S
266	557	C	2	118	439	334	0	1591	NW		RMI	BNA	0	0	0	FRAG		1991	S

BOBILA MADURELL  
MAS DURAN  
Objectes Coordenats C5  
Campanya 1991

c	c	C	N										ALTERACIONS	P	D				
uX	uY	O	I	NUM.	X	Y	Zsup	Zinf	ORIENT	PENDENT	MATERIA	OBJECTE	LONG	AMPL	ESPE	OBSERVACIONS	ANY	U	I
a	a	N	V															N	B
d	d	J																T	U
266	557	c	2	119	492	277	0	1567	E		RMI	BNA	0	0	0	FRAG	1991	S	
266	557	c	2	120	365	319	0	1591	P		SORRENCA	BNA	0	0	0		1991	S	
266	557	c	2	121	443	282	0	1581	N		RMI	BNA	0	0	0	FRAG	1991	S	
266	557	c	2	122	423	205	0	1568	S		CONGLOME	BNA	0	0	0	FRAG MICROCONGL	1991	S	
266	557	c	2	123	426	129	0	1565	N		RMI	BNA	0	0	0	FRAG	1991	S	
266	557	c	2	124	404	93	0	1558	N		CERAMICA	APLICA	0	0	0	CORDO	1991	S	
266	557	c	2	125	386	237	0	1585	NE		RMI	BNA	0	0	0		1991	S	
266	557	c	2	126	374	232	0	1584	SE		CALCARIA	BNA	0	0	0	FRAG	1991	S	
266	557	c	2	127	248	281	0	1608	NE		ESQUIST	BNA	0	0	0	FRAG	1991	S	
266	557	c	2	128	376	156	0	1575	NW		CERAMICA	VORA	0	0	0		1991	S	
266	557	c	2	129	326	120	0	1577	V		QUARS	BNA	0	0	0	FRAC?	1991	S	
266	557	c	2	130	376	156	0	1577	W		RMI	BNA	0	0	0	FRAG	1991	S	
266	557	c	2	131	370	64	0	1566	P		CERAMICA	VORA	0	0	0		1991	S	
266	557	c	2	132	315	60	0	1574	P		RMI	BNA	0	0	0	FRAG	1991	S	
266	557	c	2	133	308	167	0	1586	S		RMI	BNA	0	0	0	FRAG	1991	S	
266	557	c	2	134	305	222	0	1592	SW		QUARS	BNA	0	0	0	FRAG	1991	S	
266	557	c	2	135	236	197	0	1601	P		RMI	BNA	0	0	0	FRAG	1991	S	
266	557	c	2	137	164	184	0	1615	P		RMI	BNA	0	0	0		1991	S	
266	557	c	2	138	61	117	0	1600	W		RMI	BNA	0	0	0	FRAG	1991	S	
266	557	c	2	139	152	69	0	1598	N		RMI	BNA	0	0	0		1991	S	
266	557	c	2	140	52	54	0	1600	P		RMI	BNA	0	0	0	FRAG	1991	S	
266	557	c	2	141	180	236	0	1600	V		SORRENCA	FRAG	0	0	0		1991	S	
266	557	c	2	142	125	390	0	1636	NW		INDET	FRAG	0	0	0		1991	S	
266	557	c	2	143	107	330	0	1643	NW		INDET	FRAG	0	0	0		1991	S	
266	557	c	2	144	227	345	0	1614	P		RMI	BNA	0	0	0	FRAG	1991	S	
266	557	c	2	145	187	395	0	1627	N		INDET	BNA	0	0	0		1991	S	
266	557	c	2	146	179	446	0	1634	N		RMI	BNA	0	0	0	FRAG	1991	S	
266	557	c	2	147	291	299	0	1603	N		SORRENCA	BNA	0	0	0	FRAG	1991	S	
266	557	c	2	148	265	480	0	1617	N		CONGLOME	BNA	0	0	0	FRAG MICROCONGL	1991	S	
266	557	c	2	149	264	546	0	1629	NE		CONGLOME	BNA	0	0	0	FRAG MICROCONGL	1991	S	
266	557	c	2	150	44	323	0	1647	E		RMI	BNA	0	0	0	FRAG	1991	S	
266	557	c	2	151	325	336	0	1611	S		CALCARIA	BN1G	0	0	0		1991	S	
266	557	c	2	152	408	398	0	1596	P		CERAMICA	PANXA	0	0	0		1991	S	
266	557	c	2	153	660	490	0	1589	W		CALCARIA	BNA	0	0	0	FRAG CREMAT	1991	S	
266	557	c	2	154	425	463	0	1580	P		INDET	BP	0	0	0		1991	S	
266	557	c	2	155	922	382	0	1590	P		OS	INDET	0	0	0		1991	S	
266	557	c	2	156	621	373	0	1601	P		QUARS	BNA	0	0	0	FRAG	1991	S	
266	557	c	2	157	585	474	0	1603	NE		RMI	BNA	0	0	0		1991	S	
266	557	c	2	158	988	473	0	1567	E		CONGLOME	BNA	0	0	0	2 FRAGS MICROCO	1991	S	
266	557	c	2	159	765	861	0	1620	N		CERAMICA	INFORME	0	0	0	CREMAT VENTR	1991	S	
266	557	c	2	160	848	872	0	1618	P		SORRENCA	BNA	0	0	0	FRAG ALTERAT	1991	S	
266	557	c	2	161	116	169	0	1634	V		RMI	BNA	0	0	0	FRAG	1991	S	
266	557	c	2	162	296	358	0	1619	N		CERAMICA	INFORME	0	0	0		1991	S	
266	557	c	2	163	958	179	0	1605	NW		INDET	BNA	0	0	0	2 FRAGS	1991	S	
266	557	c	2	164	920	313	0	1615	P		RMI	BNA	0	0	0	FRAG	1991	S	
266	557	c	2	165	776	341	0	1624	V		QUARS	BNA	0	0	0	FRAG	1991	S	
266	557	c	2	167	892	791	0	1619	P		OS	INDET	0	0	0		1991	S	
266	557	c	2	168	682	729	0	1623	N		CALCARIA	BPI	0	0	0		1991	S	
266	557	c	2	169	675	664	0	1612	SW		RMI	BNA	0	0	0		1991	S	
266	557	c	2	170	679	619	0	1612	SE		TOVOT	FRAG	0	0	0		1991	S	

127

BOBILA MADURELL  
MAS DURAN  
Objectes Coordenats C5  
Campanya 1991

c	c	C	N										ALTERACIONS	P	D				
uX	uY	O	I	NUM.	X	Y	Zsup	Zinf	ORIENT	PENDENT	MATERIA	OBJECTE	LONG	AMPL	ESPE	OBSERVACIONS	ANY	U	I
a	a	N	V															N	B
d	d	J																T	U
266	557	C	2	171	658	511	0	1624	P		QUARS	BPI	0	0	0		1991	S	
266	557	C	2	172	519	562	0	1614	SW		RMI	BNA	0	0	0	FRAG	1991	S	
266	557	C	2	173	428	556	0	1618	V		QUARS	BNA	0	0	0	FRAG	1991	S	
266	557	C	2	174	436	526	0	1626	S		CALCARIA	BNA	0	0	0	FRAG ALTERAT	1991	S	
266	557	C	2	175	256	430	0	1631	W		CALCARIA	BNA	0	0	0	FRAG	1991	S	
266	557	C	2	176	258	229	0	1618	N		RMI	BNA	0	0	0	FRAG	1991	S	
266	557	C	2	177	257	97	0	1595	P		CONGLOME	BNA	0	0	0	FRAG MICROCONGL	1991	S	
266	557	C	2	178	381	63	0	1626	V		QUARS	BNA	0	0	0	FRAG	1991	S	
266	557	C	2	179	449	45	0	1628	V		QUARS	BNA	0	0	0	FRAC	1991	S	
266	557	C	2	180	643	695	0	1617	V		SORRENCA	FRAG	0	0	0		1991		
266	557	C	2	181	508	959	0	1629	N		OS	DET	0	0	0	3 FRAGS	1991	S	
266	557	C	2	182	453	774	0	1620	P		SORRENCA	FRAG	0	0	0	ALTERAT 2FRG	1991		
266	557	C	2	183	367	776	0	1639	N		SORRENCA	FRAG	0	0	0		1991		
266	557	C	2	184	442	670	0	1620	E		SORRENCA	FRAG	0	0	0		1991		
266	557	C	2	185	412	681	0	1635	N		SORRENCA	FRAG	0	0	0		1991		
266	557	C	2	186	358	717	0	1616	N		SORRENCA	FRAG	0	0	0		1991		
266	557	C	2	187	292	636	0	1627	P		CONGLOME	CODOLF	0	0	0		1991		
266	557	C	2	188	302	576	0	1627	NE		SORRENCA	FRAG	0	0	0		1991		
266	557	C	2	189	49	655	0	1656	SE		OS	DET	0	0	0	VT	1991	S	
266	557	C	2	190	58	553	0	1648	NE		SORRENCA	FRAG	0	0	0		1991		
266	557	C	2	191	140	531	0	1648	N		SORRENCA	FRAG	0	0	0		1991		
266	557	C	2	192	140	468	0	1653	NW		CONGLOME	FRAG	0	0	0		1991		
266	557	C	2	193	65	445	0	1662	V		SORRENCA	CODOLF	0	0	0		1991		
266	557	C	2	194	377	163	0	1646	V		QUARS	BPF	0	0	0		1991	S	
266	557	C	2	195	238	684	0	1645	V		SILEX	BPI	0	0	0		1991	S	
266	557	C	2	196	351	12	0	1654	P		CERAMICA	INFORME	0	0	0		1991	S	
266	557	C	2	197	238	668	0	1646	W		RMI	BNA	0	0	0	FRAG	1991	S	
266	557	C	2	198	171	644	0	1676	W		RMI	BNA	0	0	0	FRAG CREMAT	1991	S	
266	557	C	2	199	124	687	0	1677	NW		SORRENCA	BNA	0	0	0	FRAG	1991	S	
266	557	C	2	200	68	765	0	1703	P		QUARS	BNA	0	0	0	FRAG	1991	S	
266	557	C	2	201	35	552	0	1689	P		ESQUIST	BNA	0	0	0	2 FRAGS	1991	S	
266	557	C	2	202	103	412	0	1685	W		RMI	BPI	0	0	0		1991	S	
266	557	C	2	203	26	382	0	1695	S		RMI	BPF	0	0	0		1991	S	
266	557	C	2	204	41	258	0	1712	P		CERAMICA	INFORME	0	0	0		1991	S	
266	557	C	2	205	392	179	0	1635	W		CERAMICA	VORA	0	0	0		1991	S	
266	557	C	2	206	177	701	0	1688	NW		OS	INDET	0	0	0		1991	S	
266	557	C	2	207	262	795	0	1680	N		CERAMICA	VORA	0	0	0		1991	S	
266	557	C	2	208	275	828	0	1680	W		CERAMICA	INFORME	0	0	0		1991	S	
266	557	C	3	209	14	148	0	1727	E		CALCARIA	BNA	0	0	0	FRAG CREMAT	1991	S	
266	557	C	3	210	365	651	0	1657	E		RMI	BNA	0	0	0		1991	S	
266	557	C	3	211	347	729	0	1684			OS	DET	0	0	0		1991	S	
266	557	C	3	213	356	841	0	1679	N		OS	INDET	0	0	0		1991	S	
266	557	C	3	214	408	901	0	1680	NW		RMI	BNA	0	0	0	FRAG	1991	S	
266	557	C	3	215	612	826	0	1656	N		CERAMICA	INFORME	0	0	0		1991	S	
266	557	C	3	216	767	845	0	1648	S		CERAMICA	INFORME	0	0	0		1991	S	
266	557	C	3	217	870	916	0	1662			OS	INDET	0	0	0		1991	S	
266	557	C	3	218	869	873	0	1648	W		QUARS	BNA	0	0	0	FRAG	1991	S	
266	557	C	3	219	645	721	0	1669	N		CERAMICA	INFORME	0	0	0		1991	S	
266	557	C	3	220	709	301	0	1660	S		RMI	BNA	0	0	0	FRAG	1991	S	
266	557	C	3	221	758	301	0	1660	W		CERAMICA	INFORME	0	0	0		1991	S	

BOBILA MADURELL  
MAS DURAN  
Objectes Coordenats C5  
Campanya 1991

														ALTERACIONS		P D				
c	c	C	N																	
UX	UY	O	I	NUM.	X	Y	Zsup	Zinf	ORIENT	PENDENT	MATERIA	OBJECTE	LONG	AMPL	ESPE	OBSERVACIONS	ANY	U	I	
a	a	N	V																N	B
d	d	J																	T	U
266	557	C	3	222	433	45	0	1690	SW		OS	DET	0	0	0	EI	1991	S		
266	557	C	3	223	756	688	0	1689	V		OS	DET	0	0	0	VT	1991	S		
266	557	C	3	224	370	835	0	1709	S		OS	INDET	0	0	0	VARIS FRAGS	1991	S		
266	557	C	3	225	793	531	0	1677	P		OS	DET	0	0	0	FRAGS HOM	1991	S		
266	557	C	3	226	726	831	0	1677	SW		OS	DET	0	0	0	DENT	1991	S		
266	557	C	3	227	270	663	0	1710			OS	INDET	0	0	0		1991	S		
266	557	C	3	228	543	746	0	1685	N-S	P	ESQUIST	BNA	0	0	0	FRAG	1991	S		
266	557	C	3	229	841	843	0	1701	P		OS	DET	0	0	0	DENT	1991	S		
266	557	C	3	230	640	806	0	1690	P		OS	INDET	0	0	0		1991	S		
266	557	C	3	231	827	785	0	1703	P		CONGLOME	BNA	0	0	0	FRAG	1991	S		
266	557	C	3	232	760	379	0	1698	P		QUARSITA	BNA	0	0	0		1991	S		
266	557	C	3	233	588	189	0	1689	P		CALCARIA	BNA	0	0	0		1991	S		
266	557	C	3	234	332	14	0	1730	P		QUARSITA	BNA	0	0	0	FRAG	1991	S		
266	557	C	3	235	310	661	0	1713	V		CALCARIA	BNA	0	0	0	FRAG	1991	S		
266	557	C	3	236	887	844	0	1698	P		OS	DET	0	0	0	GRAG CST	1991	S		
266	557	C	3	237	258	933	0	1705	P		CERAMICA	VORA	0	0	0		1991	S		
266	557	C	3	238	563	582	0	1693	SW		OS	DET	0	0	0	FRAG CST	1991	S		
266	557	C	3	239	743	716	0	1704	SW		OS	DET	0	0	0	FRAG CST	1991	S		
266	557	C	3	240	361	9	0	1730	S		OS	DET	0	0	0	VT	1991	S		
266	557	C	3	241	453	114	0	1715	P		OS	DET	0	0	0	VT	1991	S		
266	557	C	3	242	662	420	0	1716	P		OS	DET	0	0	0	CST	1991	S		
266	557	C	3	243	412	442	0	1715	P		OS	DET	0	0	0	CST	1991	S		
266	557	C	3	244	408	584	0	1723	P		OS	INDET	0	0	0		1991	S		
266	557	C	3	245	85	556	0	1740	N		CERAMICA	INFORME	0	0	0		1991	S		
266	557	C	3	246	243	765	0	1733	E		OS	INDET	0	0	0		1991	S		
266	557	C	3	247	292	797	0	1729	P		OS	INDET	0	0	0		1991	S		
266	557	C	3	248	346	817	0	1722			OS	INDET	0	0	0		1991	S		
266	557	C	3	249	375	892	0	1744	N		RMI	BNA	0	0	0	FRAG	1991	S		
266	557	C	3	250	474	960	0	1731	P		OS	DET	0	0	0	MD Inf	1991	S		
266	557	C	3	251	207	939	0	1746	N		CERAMICA	INFORME	0	0	0		1991	S		
266	557	C	3	252	51	862	0	1743	P		OS	INDET	0	0	0		1991	S		
266	557	C	3	253	299	873	0	1732	P		OS	INDET	0	0	0		1991	S		
266	557	C	3	254	472	446	0	1725	P		OS	INDET	0	0	0		1991	S		
266	557	C	3	255	494	448	0	1726	P		OS	INDET	0	0	0		1991	S		
266	557	C	3	256	859	200	0	1704	P		OS	DET	0	0	0	DENT	1991	S		
266	557	C	3	257	326	72	0	1731			CERAMICA	INFORME	0	0	0		1991	S		
266	557	C	3	258	315	18	0	1730	W		SORRENCA	BNA	0	0	0		1991	S		
266	557	C	3	259	472	36	0	1720	P		OS	INDET	0	0	0		1991	S		
266	557	C	3	261	632	357	0	1727	P		OS	INDET	0	0	0		1991	S		
266	557	C	3	262	562	301	0	1719	P		OS	INDET	0	0	0		1991	S		
266	557	C	3	263	169	164	0	1739	W		ESQUIST	BNA	0	0	0	FRAG	1991	S		
266	557	C	3	264	444	734	0	1746	P		ORGANIC	CARBO	0	0	0		1991	S		
266	557	C	3	265	125	787	0	1777	V		CALCARIA	BPF	0	0	0		1991	S		
266	557	C	3	266	951	561	0	1777	W		CERAMICA	INFORME	0	0	0		1991	S		
266	557	C	3	267	166	803	0	1797	V		SILEX	BNA	0	0	0	FRAG	1991	S		
129 266	557	C	3	268	541	842	0	1830	N		QUARS	BNA	0	0	0	FRAG	1991	S		
266	557	C	3	269	624	647	0	1835	P		CONGLOME	BNA	0	0	0	FRAG	1991	S		
266	557	C	3	270	809	512	0	1815	E		CERAMICA	INFORME	0	0	0		1991	S		
266	557	C	3	271	743	529	0	1890	E		CERAMICA	INFORME	0	0	0		1991	S		
266	557	C	3	272	817	461	0	1810	E		CERAMICA	INFORME	0	0	0		1991	S		

BOBILA MADURELL  
MAS DURAN  
Objectes Coordenats C5  
Campanya 1991

c	c	C	N	NUM.	X	Y	Zsup	Zinf	ORIENT	PENDENT	MATERIA	OBJECTE	LONG	AMPL	ESPE	OBSERVACIONS	ALTERACIONS	P D	
uX	uY	O	I															ANY	U I
a	a	N	V																N B
d	d	J																	T U
266	557	C	3	273	731	477	0	1806	E		CERAMICA	INFORME	0	0	0			1991	S
266	557	C	3	274	587	457	0	1781	P		CERAMICA	INFORME	0	0	0			1991	S
266	557	C	3	275	632	434	0	1790	E		CERAMICA	APLICA	0	0	0	LENGUETA		1991	S
266	557	C	3	276	646	397	0	1795			CERAMICA	INFORME	0	0	0			1991	S
266	557	C	3	277	585	400	0	1786			CERAMICA	INFORME	0	0	0			1991	S
266	557	C	3	278	553	415	0	1795	S		CERAMICA	INFORME	0	0	0			1991	S
266	557	C	3	279	537	433	0	1793	S		CERAMICA	INFORME	0	0	0			1991	S
266	557	C	3	280	143	704	0	1820	P		QUARSITA	BNA	0	0	0	FRAG		1991	S
266	557	C	3	281	30	502	0	1826	SW		OS	DET	0	0	0			1991	S
266	557	C	3	282	66	709	1827	1764	N		OS	DET	0	0	0			1991	S
266	557	C	3	283	764	987	0	1811	V		OS	DET	0	0	0			1991	S
266	557	C	3	284	453	641	0	1820	E		QUARS	BPI	0	0	0			1991	S
266	557	C	3	285	849	622	0	1815	P		RMI	BPF	0	0	0			1991	S
266	557	C	3	286	366	731	0	1825	P		RMI	BP	0	0	0			1991	S
266	557	C	3	287	337	855	0	1813	P		OS	INDET	0	0	0			1991	S
266	557	C	3	288	145	983	0	1874	P		SORRENCA	BNA	0	0	0			1991	S
266	557	C	3	289	66	762	0	1880	P		RMI	BNA	0	0	0			1991	S
266	557	C	3	290	173	431	1770	1865	SE		CONGLOME	BNA	0	0	0	MICROCONGLOME		1991	S
266	557	C	3	291	288	397	0	1863	S		CERAMICA	INFORME	0	0	0			1991	S
266	557	C	3	292	348	401	0	1875	P		QUARS	BNA	0	0	0			1991	S
266	557	C	3	293	566	578	0	1862	P		QUARS	BNA	0	0	0	FRAC		1991	S
266	557	C	3	294	698	947	0	1870	N		RMI	BNA	0	0	0	FRAG		1991	S
266	557	C	3	295	852	662	0	1840	E		RMI	BPF	0	0	0			1991	S
266	557	C	3	296	926	544	0	1859	P		RMI	BNA	0	0	0	FRAG		1991	S
266	557	C	3	297	305	347	0	1878	W		CERAMICA	INFORME	0	0	0	2 FRAGS		1991	S
266	557	C	3	298	482	91	0	1875	S		CERAMICA	INFORME	0	0	0	CREMAT		1991	S
266	557	C	3	299	20	897	0	1905	E		SORRENCA	BNA	0	0	0	ALTERAT		1991	S
266	557	C		300	241	136	0	1895	P		CERAMICA	VORA	0	0	0	2 FRAGS		1991	S
266	557	C		301	613	134	0	1890			INDET	BNA	0	0	0	FRAG		1991	S
266	558	C		1	725	508	0	1231	E		CALCARIA	BNA	0	0	0	FRAG ALTERAT		1991	S
266	558	C		2	708	633	0	1230	E		SORRENCA	BNA	0	0	0	FRAG		1991	S
266	558	C		3	672	689	0	1224	P		CERAMICA	VORA	0	0	0			1991	S
266	558	C		4	507	641	0	1231	NW		QUARS	BNA	0	0	0	FRAG		1991	S
266	558	C		5	419	794	0	1210	NE		SORRENCA	BNA	0	0	0	FRAG		1991	S
266	558	C		6	202	990	0	1205	P		CERAMICA	APLICA	0	0	0	CORDO		1991	S
266	558	C		7	1	265	0	1244	E		CERAMICA	INFORME	0	0	0			1991	S
266	558	C		8	238	223	0	1255	P		CERAMICA	INFORME	0	0	0			1991	S
266	558	C		9	868	615	0	1276	P		QUARS	BP	0	0	0			1991	S
266	558	C		10	38	696	0	1278	P		RMI	BNA	0	0	0	FRAG		1991	S
266	558	C		11	77	738	0	1296	SE		CERAMICA	APLICA	0	0	0	MAMELO		1991	S
266	558	C		12	110	867	0	1292	E		RMI	BNA	0	0	0	FRAG		1991	S
266	558	C		13	344	877	0	1254	S		RMI	BNA	0	0	0	FRAG		1991	S
266	558	C		14	415	882	0	1250	S		RMI	BNA	0	0	0	FRAG		1991	S
266	558	C		15	573	836	0	1281	S		QUARS	BNA	0	0	0			1991	S
266	558	C		16	956	550	0	1312	P		RMI	BNA	0	0	0	FRAG		1991	S
266	558	C		17	761	557	1258	1304	S		SORRENCA	BNA	0	0	0	FRAG		1991	S
266	558	C		18	481	227	0	1295	P		CALCARIA	BNA	0	0	0	FRAG		1991	S
266	558	C		19	396	526	0	1296	P		CALCARIA	BNA	0	0	0	NO RECUPERAT		1991	S
266	558	C	2	20	125	316	0	1308	P		CERAMICA	INFORME	0	0	0			1991	S
266	558	C	2	21	405	209	0	1320	SE		CERAMICA	INFORME	0	0	0			1991	S

BOBILA MADURELL  
MAS DURAN  
Objectes Coordinats C5  
Campanya 1991

c	c	C	N				ALTERACIONS				P	D												
uX	uY	O	I	NUM.	X	Y	Zsup	Zinf	ORIENT	PENDENT	MATERIA	OBJECTE	LONG	AMPL	ESPE	OBSERVACIONS	ANY	U	I	N	B	T	U	
a	a	N	V																					
d	d	J																						
266	558	C	2	23	200	55	0	1365	SE		SORRENCA	BNA	0	0	0	FRAG	1991	S						
266	558	C	2	24	315	173	0	1350	P		CERAMICA	INFORME	0	0	0	2 FRAGS	1991	S						
266	558	C	2	25	452	157	0	1341	S		QUARSITA	BNA	0	0	0		1991	S						
266	558	C	2	26	444	215	0	1349	NW		SORRENCA	BNA	0	0	0	FRAG	1991	S						
266	558	C	2	27	485	248	0	1342			CERAMICA	INFORME	0	0	0	VARIS FRAGS	1991	S						
266	558	C	2	28	660	242	0	1331	S		GRANIT	BNA	0	0	0	FRAG	1991	S						
266	558	C	2	29	137	390	0	1346	S		SORRENCA	BNA	0	0	0	FRAG	1991	S						
266	558	C	2	31	599	381	0	1337	NW		INDET	BNA	0	0	0	FRAG	1991	S						
266	558	C	2	33	913	474	0	1351	NW		CALCARIA	BN1G	0	0	0		1991	S						
266	558	C	2	34	863	483	0	1337	N		CERAMICA	INFORME	0	0	0		1991	S						
266	558	C	2	35	860	523	0	1337	P		CERAMICA	INFORME	0	0	0		1991	S						
266	558	C	2	36	956	535	0	1342	SW		RMI	BNA	0	0	0	FRAG	1991	S						
266	558	C	2	37	51	578	0	1337	SE		QUARS	BNA	0	0	0		1991	S						
266	558	C	2	38	847	646	0	1354	S		CERAMICA	INFORME	0	0	0		1991	S						
266	558	C	2	39	837	734	0	1338	P		CALCARIA	BPI	0	0	0	ESCLAT TERMIC?	1991	S						
266	558	C	2	40	981	763	0	1326	P		CERAMICA	INFORME	0	0	0		1991	S						
266	558	C	2	41	818	401	0	1366	SE		QUARS	BNA	0	0	0	FRAG	1991	S						
266	558	C	2	42	763	479	0	1342	SE		CALCARIA	FRAG	0	0	0	FRACTURAT	1991	S						
266	558	C	2	43	623	435	0	1348	SE		QUARS	BNA	0	0	0	FRAG	1991	S						
266	558	C	2	46	233	587	0	1335	NE		SORRENCA	BNA	0	0	0	FRAG ALTERAT	1991	S						
266	558	C	2	47	38	689	0	1321	NW		RMI	BNA	0	0	0	FRAG	1991	S						
266	558	C	2	48	516	494	0	1343	NW		QUARS	BP2G	0	0	0		1991	S						
266	558	C	2	49	19	49	0	1368	P		QUARS	BNA	0	0	0	FRAG	1991	S						
266	558	C	2	50	275	342	0	1370	NE		RMI	BNA	0	0	0	FRAG	1991	S						
266	558	C	2	51	186	669	0	1363	P		QUARS	BNA	0	0	0	FRAC	1991	S						
266	558	C	2	53	373	23	0	1375	V		QUARSITA	BP2G	0	0	0		1991							
266	558	C	2	54	424	19	0	1404	NW		SORRENCA	BNA	0	0	0	FRAG	1991	S						
266	558	C	2	55	487	42	0	1391	S		RMI	BNA	0	0	0		1991	S						
266	558	C	2	56	685	78	0	1363	P		CERAMICA	INFORME	0	0	0		1991	S						
266	558	C	2	57	727	372	0	1385	P		RMI	BNA	0	0	0		1991	S						
266	558	C	2	58	810	69	0	1378	NW		RMI	BNA	0	0	0	FRAG	1991	S						
266	558	C	2	59	799	118	0	1385	V		SORRENCA	CODOLF	0	0	0		1991							
266	558	C	2	61	855	254	0	1345	SE		RMI	BNA	0	0	0	FRAG	1991	S						
266	558	C	2	62	916	346	0	1363	W		INDET	BNA	0	0	0	FRAG	1991	S						
266	558	C	2	63	997	379	0	1367	W		CONGLOME	BNA	0	0	0	FRAG MICROCONGL	1991	S						
266	558	C	2	64	743	600	0	1414	N		SORRENCA	BNA	0	0	0		1991	S						
266	558	C	2	65	333	112	0	1392	NE		SORRENCA	BNA	0	0	0	FRAG	1991	S						
266	558	C	2	66	322	211	0	1406	W		SORRENCA	BNA	0	0	0	FRAG	1991	S						
266	558	C	2	68	150	314	0	1407	NW		QUARS	BNA	0	0	0	FRAG	1991	S						
266	558	C	2	69	200	366	0	1400	P		CERAMICA	INFORME	0	0	0		1991	S						
266	558	C	2	70	189	483	0	1394	NW		QUARS	BNA	0	0	0	FRAG	1991	S						
266	558	C	2	71	172	523	0	1398	NW		SORRENCA	BNA	0	0	0	FRAG	1991	S						
266	558	C	2	72	246	136	0	1445	V		INDET	BNA	0	0	0	FRAG NO RECUPER	1991	S						
266	558	C	2	73	486	124	0	1435	SW		QUARS	BNA	0	0	0	FRAG	1991	S						
266	558	C	2	74	567	1	0	1422	S		RMI	BNA	0	0	0	FRAG	1991	S						
131	266	558	C	2	75	658	221	0	1425	N	OS	INDET	0	0	0		1991	S						
266	558	C	2	76	689	313	0	1444			CERAMICA	INFORME	0	0	0	NO RECUPERAT	1991	S						
266	558	C	2	77	701	437	0	1430	S		CERAMICA	APLICA	0	0	0	MJGRO	1991	S						
266	558	C	2	78	733	454	0	1430	S		CERAMICA	INFORME	0	0	0		1991	S						
266	558	C	2	79	807	421	0	1430	S		CALCARIA	FRAG	0	0	0	ALTERAT NO RECUPERAT	1991	S						

BOBILA MADURELL  
MAS DURAN  
Objectes Coordinats C5  
Campanya 1991

c	c	C	N	NUM.	X	Y	Zsup	Zinf	ORIENT	PENDENT	MATERIA	OBJECTE	LONG	AMPL	ESPE	ALTERACIONS		P	D
																OBSERVACIONS	ANY	U	I
uX	uY	O	I																
a	a	N	V															N	B
d	d	J																T	U
266	558	C	2	80	910	409	0	1440	S		CERAMICA	INFORME	0	0	0			1991	S
266	558	C	2	81	890	483	0	1435	V		QUARS	BNA	0	0	0	FRAG		1991	S
266	558	C	2	82	857	608	0	1425	S		SORRENCA	BNA	0	0	0	ALTERAT		1991	S
266	558	C	2	83	925	637	0	1417	S		RMI	BNA	0	0	0	FRAG		1991	S
266	558	C	2	84	340	445	0	1456	S		RMI	BNA	0	0	0	FRAG		1991	S
266	558	C	2	85	431	191	0	1489	P		QUARS	BNA	0	0	0	FRAG		1991	S
266	558	C	2	86	400	108	0	1478	N		CERAMICA	VORA	0	0	0			1991	S
266	558	C	2	87	687	76	0	1469	N		RMI	BNA	0	0	0	FRAG		1991	S
266	558	C	2	88	696	196	0	1489	P		QUARS	FRAG	0	0	0	NO RECUPERAT		1991	S
266	558	C	2	89	431	132	0	1514	P		CERAMICA	INFORME	0	0	0			1991	S
266	558	C	2	90	487	174	0	1533	W		CERAMICA	INFORME	0	0	0			1991	S
266	558	C	2	91	431	132	0	1503	SW		SORRENCA	BNA	0	0	0	FRAG		1991	S
266	558	C	2	92	487	174	0	1519	W		SORRENCA	BNA	0	0	0	FRAG		1991	S
266	558	C	2	94	245	322	0	1514	P		RMI	BNA	0	0	0	FRAG		1991	S
266	558	C	2	95	382	359	0	1512	S		CALCARIA	BNA	0	0	0	FRAG		1991	S
266	558	C	2	96	404	234	0	1501	V		QUARS	BNA	0	0	0	FRAG		1991	S
266	558	C	2	97	583	360	0	1443	E		SORRENCA	BNA	0	0	0	FRAG		1991	S
266	558	C	2	98	664	471	0	1500	P		QUARS	BNA	0	0	0	FRAG		1991	S
266	558	C	2	99	757	616	0	1480	P		SORRENCA	BNA	0	0	0	FRAG		1991	S
266	558	C	2	100	217	297	0	1520	V		CALCARIA	BNA	0	0	0	FRAC		1991	S
266	558	C	2	101	577	561	0	1562			CERAMICA	INFORME	0	0	0			1991	S
266	558	C	2	102	322	259	0	1564	P		CERAMICA	INFORME	0	0	0			1991	S
266	558	C	2	103	324	208	0	1557	P		CERAMICA	INFORME	0	0	0			1991	S
266	558	C	2	104	768	222	0	1608	SE		CERAMICA	INFORME	0	0	0			1991	S
266	558	C	2	105	852	238	0	1634			QUARS	BNA	0	0	0	FRAC		1991	S
266	558	C	3	106	834	578	0	1607	NE-SW	V	CERAMICA	INFORME	0	0	0			1991	S
266	558	C	3	107	930	268	0	1637	NW-SE	P	OS	INDET	0	0	0			1991	S
266	558	C	3	108	342	900	1613	1637	N-S	P	CERAMICA	VORA	0	0	0	2 FRAGS		1991	S
266	558	C	3	109	289	834	0	1624	N-S	P	CALCARIA	BPF	0	0	0			1991	S
266	558	C	3	110	204	547	0	1644	NE-SW	V	RMI	BPF	0	0	0			1991	S
266	558	C	3	111	480	576	0	1630	NW-SE	P	CERAMICA	INFORME	0	0	0	2 FRAGS		1991	S
266	558	C	3	112	605	878	0	1642	NE-SW	P	RMI	BNA	0	0	0	FRAG		1991	S
266	558	C	3	113	915	916	0	1625	E-W	P	CERAMICA	INFORME	0	0	0			1991	S
266	558	C	3	114	678	135	0	1677			ORGANIC	CARBO	0	0	0			1991	S
266	558	C	3	115	152	930	0	1700	P		CERAMICA	INFORME	0	0	0			1991	S
266	558	C	3	116	256	927	0	1740	E-W		CERAMICA	INFORME	0	0	0			1991	S
266	558	C	3	117	932	965	0	1681	P		RMI	BNA	0	0	0			1991	S
266	558	C	3	118	854	167	0	1710	P		OS	INDET	0	0	0			1991	S
266	558	C	3	119	912	29	0	1720	V		SORRENCA	BNA	0	0	0	FRAG		1991	S
266	558	C	3	120	651	205	0	1723	SW		QUARS	BNA	0	0	0	FRAG		1991	S
266	558	C	3	121	692	563	0	1700	P		CERAMICA	INFORME	0	0	0	VARIS FRAGS		1991	S
266	558	C	3	122	319	856	0	1725	W		RMI	BNA	0	0	0	FRAG		1991	S
266	558	C	3	123	930	654	0	1703	P		OS	DET	0	0	0	FRAG CST		1991	S
266	558	C	3	124	729	44	0	1743	P		OS	DET	0	0	0	FRAG		1991	S
266	558	C	3	125	705	50	0	1736	P		OS	INDET	0	0	0	FRAG		1991	S
266	558	C	3	126	375	80	0	1775	P		ORGANIC	CARBO	0	0	0			1991	S
266	558	C	3	127	621	78	0	1763	P		OS	DET	0	0	0	DENT		1991	S
266	558	C	3	128	952	402	0	1775	P		ESQUIST	BNA	0	0	0	FRAG		1991	S
266	558	C	3	129	476	253	0	1796	SE		SILEX	BPF	0	0	0			1991	S
266	558	C	3	130	419	353	0	1792	NW		INDET	BNA	0	0	0	FRAG		1991	S





BOBILA MADURELL  
MAS DURAN  
Objectes Coordenats C5  
Campanya 1991

												ALTERACIONS		P D									
c	c	C	N	NUM.	X	Y	Zsup	Zinf	ORIENT	PENDENT	MATERIA	OBJECTE	LONG	AMPL	ESPE	OBSERVACIONS	ANY	U	I	N	B	T	U
uX	uY	O	I																				
a	a	N	V																				
d	d	J																					
266	558	C	3	181	262	466	0	1921	V		QUARSITA	BNA	0	0	0		1991	S					
266	558	C	3	182	371	486	0	1908	NE		CERAMICA	INFORME	0	0	0		1991	S					
266	558	C	3	183	183	447	0	1920	E		RMI	BNA	0	0	0		1991	S					
266	558	C	3	184	194	570	0	1935	P		RMI	BNA	0	0	0	FRAG	1991	S					
266	558	C	3	185	115	699	0	1946	P		RMI	BNA	0	0	0		1991	S					
266	558	C	3	186	386	449	0	1910			CERAMICA	INFORME	0	0	0		1991	S					
266	558	C	3	187	440	185	0	1890	E		CERAMICA	INFORME	0	0	0		1991	S					
266	558	C	3	188	710	394	0	1880	P		RMI	BNA	0	0	0	FRAG	1991	S					
266	558	C	3	189	560	545	0	1900	V		ESQUIST	BNA	0	0	0	FRAG	1991	S					
266	558	C	3	190	633	700	0	1890	V		CERAMICA	INFORME	0	0	0		1991	S					
266	558	C	3	191	703	154	0	1892	SW		CALCARIA	BPF	0	0	0		1991	S					
266	558	C	3	192	196	508	0	1947			TOVOT	FRAG	0	0	0		1991	S					
266	558	C	3	193	238	523	0	1962	W		CERAMICA	APLICA	0	0	0	LLENGUETA	1991	S					
266	558	C	3	194	502	606	0	1950	V		RMI	BNA	0	0	0	FRAG	1991	S					
266	558	C	3	195	432	664	0	1942	V		RMI	BNA	0	0	0		1991	S					
266	558	C	3	196	455	756	0	1918			CERAMICA	INFORME	0	0	0		1991	S					
266	558	C	3	197	469	691	0	1931			CERAMICA	INFORME	0	0	0		1991	S					
266	558	C	3	198	287	451	0	1964	W		CERAMICA	INFORME	0	0	0		1991	S					
266	558	C	3	199	84	828	0	1950	P		CONGLOME	BNA	0	0	0	MICROCONGL FRAG	1991	S					
266	558	C	3	200	358	678	0	1948	N		RMI	BNA	0	0	0	FRAG	1991	S					
266	558	C	3	201	136	231	0	1930			ORGANIC	CARBO	0	0	0		1991	S					
266	558	C	3	202	252	577	0	1954	NW		CERAMICA	INFORME	0	0	0		1991	S					
266	558	C	3	203	28	343	0	1941	P		CALCARIA	BPF	0	0	0	2 FRAGS	1991	S					
266	558	C	3	204	425	771	0	1984	V		CALCARIA	BP	0	0	0		1991	S					
266	558	C	3	205	329	609	0	2000	V		CALCARIA	BNA	0	0	0	FRAC?	1991	S					
266	558	C	3	206	303	839	0	1979	P		CERAMICA	INFORME	0	0	0		1991	S					
266	558	C	3	207	297	911	0	1991	W		RMI	BNA	0	0	0		1991	S					
266	558	C	3	208	152	806	0	1992	P		QUARSITA	BPF	0	0	0		1991	S					
266	558	C	3	209	366	533	0	2001	NW		CERAMICA	PANXA	0	0	0		1991	S					
266	558	C	3	210	413	643	0	2024	V		QUARS	BNA	0	0	0	FRAC	1991	S					
266	558	C	3	211	356	652	0	2005	P		CERAMICA	INFORME	0	0	0		1991	S					
266	558	C	3	212	263	733	0	2014	W		CERAMICA	INFORME	0	0	0		1991	S					
266	558	C	3	213	199	718	0	2005	V		CERAMICA	INFORME	0	0	0		1991	S					
266	558	C	3	214	162	963	0	2014	P		OS	DET	0	0	0	DENT	1991	S					
266	558	C	3	215	237	484	0	2002	NW		OS	INDET	0	0	0		1991	S					
266	558	C	3	216	55	600	0	2025	NE		CERAMICA	INFORME	0	0	0		1991	S					
266	558	C	3	217	71	646	0	2026	E		CERAMICA	INFORME	0	0	0		1991	S					
266	558	C	3	218	246	647	0	2034	V		SORRENCA	BNA	0	0	0	ALTERAT	1991	S					
266	558	C	3	219	498	874	0	2037	V		RMI	BNA	0	0	0		1991	S					
266	558	C	3	220	83	990	0	2049	W		CERAMICA	INFORME	0	0	0		1991	S					
266	558	C	3	221	159	523	0	2023	P		OS	INDET	0	0	0		1991	S					
266	558	C	3	222	129	449	0	2057	N		QUARS	BNA	0	0	0	FRAC	1991	S					
266	558	C	3	223	126	667	0	2066	SE		CONGLOME	BNA	0	0	0	MICROCONGL FRAG	1991	S					
266	558	C	3	224	285	832	0	2074	P		CALCARIA	BNA	0	0	0	ALTERAT	1991	S					
266	558	C	3	225	350	893	0	2085	P		OS	DET	0	0	0		1991	S					
266	558	C	3	226	362	970	0	2087	NE		CERAMICA	APLICA	0	0	0	MAMELLO LLENGUE	1991	S					
266	558	C	3	227	282	536	0	2087	NE		ESQUIST	BNA	0	0	0	FRAG	1991	S					
266	558	C	3	228	98	804	0	2082	E		CALCARIA	BNA	0	0	0	ALTERAT	1991	S					
266	558	C	3	229	259	896	0	2094	P		RMI	BNA	0	0	0	FRAC	1991	S					
266	558	C	3	230	148	415	0	2072	P		QUARS	BPI	0	0	0		1991	S					

BOBILA MADURELL  
MAS DURAN  
Objectes Coordinats C5  
Campanya 1991

c	c	C	N	NUM.	X	Y	Zsup	Zinf	ORIENT	PENDENT	MATERIA	OBJECTE	LONG	AMPL	ESPE	ALTERACIONS OBSERVACIONS	P D ANY U I N B T U
uX	uY	O	I														
a	a	N	V														
d	d	J															
266	558	C	3	231	301	700	0	2095	P		CERAMICA	INFORME	0	0	0		1991 S
266	558	C	3	232	412	727	0	2099	N		CONGLOME	BNA	0	0	0	FRAC	1991 S
266	558	C	3	233	166	856	0	2111	S		ORGANIC	CARBO	0	0	0		1991 S
266	558	C	3	234	69	762	0	2109	E		OS	INDET	0	0	0		1991 S
266	558	C	3	235	188	642	0	2115	S		RMI	BNA	0	0	0	FRAG	1991 S
266	558	C	3	236	469	650	0	2121	V		OS	DET	0	0	0	VT	1991 S
266	558	C	3	237	194	737	0	2147	P		OS	DET	0	0	0		1991 S
266	558	C	3	238	264	753	0	2149			TOVOT	FRAG	0	0	0	NO RECUPERAT	1991 S
266	558	C	3	239	310	636	0	2145	P		CERAMICA	VORA	0	0	0		1991 S
266	558	C	3	240	420	685	0	2130	P		CALCARIA	BPF	0	0	0		1991 S
266	558	C	3	241	399	852	0	2142	NE		TOVOT	FRAG	0	0	0	NO RECUPERAT	1991 S
266	558	C	3	242	392	921	0	2148	P		ESQUIST	BNA	0	0	0	FRAG	1991 S
266	558	C	3	243	92	990	0	2130	E		CALCARIA	BPF	0	0	0		1991 S
266	558	C	3	244	41	860	0	2117	N		CERAMICA	VORA	0	0	0	POSSIBLE APLICA	1991 S
266	558	C	3	245	274	964	0	2178	V		CERAMICA	INFORME	0	0	0	TERRA CUITA	1991 S
266	558	C	3	246	370	877	0	2196	P		CALCARIA	BNA	0	0	0	FRAC	1991 S
266	558	C	3	247	403	792	0	2166	P		OS	DET	0	0	0		1991 S
266	558	C	3	248	299	753	0	2171	P		TOVOT	FRAG	0	0	0		1991
266	558	C	3	249	255	978	0	2254			OS	DET	0	0	0	3 FRAGS	1991 S
266	558	C	3	250	127	645	0	2225	P		OS	INDET	0	0	0		1991 S
266	558	C	3	251	51	556	0	2240	N		CERAMICA	INFORME	0	0	0	2 FRAGS	1991 S
266	558	C	3	252	146	696	0	2227	N		QUARS	BPI	0	0	0		1991 S
266	558	C	3	253	380	831	0	2240	S		CALCARIA	BPF	0	0	0		1991 S
266	558	C	3	254	406	880	0	2243			CERAMICA	INFORME	0	0	0	TOVOT	1991 S
266	558	C	3	255	56	886	0	2259	P		QUARSITA	BPF	0	0	0		1991 S
266	558	C	3	256	304	799	0	2245			CERAMICA	INFORME	0	0	0	TOVOT	1991 S
266	558	C	3	257	47	971	0	2272	W		OS	DET	0	0	0	BA	1991 S
266	558	C	3	258	465	869	0	2288	W		RMI	BNA	0	0	0		1991 S
266	558	C	3	259	131	951	0	2282	SE		RMI	BNA	0	0	0	FRAG	1991 S
266	558	C	3	260	105	976	0	2317	P		QUARS	BNA	0	0	0	FRAC	1991 S
266	558	C	3	261	94	909	0	2309	S		SORRENCA	BNA	0	0	0		1991 S
266	558	C	3	262	194	925	0	2335	S		RMI	BNA	0	0	0	FRAG	1991 S
266	558	C	3	263	248	926	0	2330	S		QUARS	BNA	0	0	0	FRAC	1991 S
266	559	C		1	753	38	0	1317	V		SILEX	BPF	0	0	0		1991 S
266	559	C	3	2	940	471	0	1547	P		CERAMICA	INFORME	0	0	0	3 FRAGS	1991 S
266	559	C	3	3	469	642	0	1565	V		CALCARIA	BNA	0	0	0	FRAC	1991 S
266	559	C	3	4	85	92	0	1580	E		OS	DET	0	0	0	2 FRAGS	1991 S
266	559	C	3	5	66	264	0	1670	NE		CERAMICA	INFORME	0	0	0		1991 S
266	559	C	3	6	660	371	0	1597	P		CERAMICA	INFORME	0	0	0		1991 S
266	559	C	3	7	941	58	0	1584	S		CERAMICA	INFORME	0	0	0		1991 S
266	559	C	3	8	32	283	0	1599	P		CERAMICA	INFORME	0	0	0		1991 S
266	559	C	3	9	173	227	0	1610	SE		CERAMICA	INFORME	0	0	0		1991 S
266	559	C	3	10	422	232	0	1612	W		QUARS	BNA	0	0	0	FRAC	1991 S
266	559	C	3	11	756	359	0	1625	W		QUARS	BPF	0	0	0		1991 S
266	559	C	3	12	859	73	0	1624	SW		CERAMICA	INFORME	0	0	0		1991 S
266	559	C	3	13	492	407	0	1681	P		CALCARIA	BN1G	0	0	0		1991 S
266	559	C	3	14	568	431	0	1656	P		ESQUIST	BNA	0	0	0	FRAG	1991 S
266	559	C	3	15	681	424	0	1651	S		CONGLOME	BNA	0	0	0		1991 S
266	559	C	3	16	686	200	0	1646	W		RMI	BNA	0	0	0	FRAG	1991 S
266	559	C	3	17	896	383	0	1627	P		CERAMICA	INFORME	0	0	0		1991 S

BOBILA MADURELL  
MAS DURAN  
Objectes Coordenats C5  
Campanya 1991

c	c	C	M	NUM.	X	Y	Zsup	Zinf	ORIENT	PENDENT	MATERIA	OBJECTE	LONG	AMPL	ESPE	ALTERACIONS OBSERVACIONS	P D ANY U I N B T U
uX	uY	O	I														
a	a	N	V														
d	d	J															
266	559	C	3	18	650	419		0	1678	P	CERAMICA	INFORME	0	0	0		1991 S
266	559	C	3	19	744	417		0	1671	SE	CERAMICA	INFORME	0	0	0		1991 S
266	559	C	3	20	875	457		0	1661	S	CERAMICA	VORA	0	0	0		1991 S
266	559	C	3	21	61	7		0	1692	SW	CERAMICA	INFORME	0	0	0		1991 S
266	559	C	3	23	447	374		0	1700	SE	ESQUIST	BNA	0	0	0	FRAG	1991 S
266	559	C	3	24	495	453		0	1692	NW	CERAMICA	VORA	0	0	0	4 FRAGS	1991 S
266	559	C	3	25	457	396		0	1706	SW	CERAMICA	APLICA	0	0	0	2 MUGRONS	1991 S
266	559	C	3	26	386	411		0	1706	S	CERAMICA	VORA	0	0	0		1991 S
266	559	C	3	27	401	463		0	1702	SE	CERAMICA	VORA	0	0	0		1991 S
266	559	C	3	28	980	373		0	1595	P	CERAMICA	INFORME	0	0	0		1991 S
266	559	C	3	29	838	12		0	1694	W	RMI	BNA	0	0	0		1991 S
266	559	C	3	30	719	71	1559	1650		S	CONGLOME	BNA	0	0	0	FRAG MICROCONGL	1991 S
266	559	C	3	31	808	36		0	1652	S	CERAMICA	INFORME	0	0	0		1991 S
266	559	C	3	32	980	220	1565	1657		NE	CONGLOME	BNA	0	0	0	FRAG	1991 S
266	559	C	3	33	832	304	1507	1630		N	RMI	BNA	0	0	0	FRAG	1991 S
266	559	C	3	34	875	379		0	1664	N	CERAMICA	APLICA	0	0	0	LLENGUETA	1991 S
266	559	C	3	35	663	279		0	1705	S	RMI	BNA	0	0	0	FRAG	1991 S
266	559	C	3	36	81	476		0	1696	W	CONGLOME	BNA	0	0	0	FRAG MICROCONGL	1991 S
266	559	C	3	37	987	337		0	1689	S	CONGLOME	BNA	0	0	0	FRAG MICROCONGL	1991 S
266	559	C	3	38	954	366		0	1687	P	CERAMICA	INFORME	0	0	0		1991 S
266	559	C	3	39	808	376		0	1698	V	CERAMICA	INFORME	0	0	0		1991 S
266	559	C	3	40	753	38		0	1698	P	CERAMICA	INFORME	0	0	0		1991 S
266	559	C	3	41	156	502		0	1733	W	RMI	BNA	0	0	0	FRAG	1991 S
266	559	C	3	42	692	45		0	1675	P	CERAMICA	INFORME	0	0	0		1991 S
266	559	C	3	43	729	43		0	1674	P	CERAMICA	INFORME	0	0	0		1991 S
266	559	C	3	44	869	829		0	1650	P	OS	INDET	0	0	0	2 FRAGS	1991 S
266	559	C	3	45	652	884		0	1668	P	CERAMICA	INFORME	0	0	0		1991 S
266	559	C	3	46	510	331		0	1734	P	CERAMICA	INFORME	0	0	0		1991 S
266	559	C	3	47	503	140		0	1750	P	CERAMICA	INFORME	0	0	0		1991 S
266	559	C	3	48	808	322		0	1718	W	CERAMICA	VORA	0	0	0		1991 S
266	559	C	3	49	884	316		0	1714	W	CERAMICA	VORA	0	0	0		1991 S
266	559	C	3	50	995	337		0	1710	SW	CERAMICA	INFORME	0	0	0		1991 S
266	559	C	3	51	898	271		0	1715	S	CERAMICA	VORA	0	0	0		1991 S
266	559	C	3	52	860	195		0	1745	NW	RMI	BNA	0	0	0	FRAG	1991 S
266	559	C	3	53	984	173		0	1716	P	CERAMICA	APLICA	0	0	0	MAMELLO	1991 S
266	559	C	3	54	708	107		0	1744	SW	CERAMICA	PANXA	0	0	0		1991 S
266	559	C	3	55	821	124		0	1748	P	CALCARIA	BNA	0	0	0		1991 S
266	559	C	3	56	906	144		0	1730	W	RMI	BNA	0	0	0	FRAG	1991 S
266	559	C	3	57	780	49		0	1758	S	SORRENCA	BNA	0	0	0	FRAG	1991 S
266	559	C	3	58	709	193		0	1740	SE	CERAMICA	INFORME	0	0	0		1991 S
266	559	C	3	59	741	113		0	1750	P	CERAMICA	INFORME	0	0	0	VARIS FRAGS	1991 S
266	559	C	3	60	419	408		0	1764	SW	RMI	BNA	0	0	0	FRAG	1991 S
266	559	C	3	61	53	517		0	1763		ORGANIC	CARBO	0	0	0		1991
266	559	C	3	62	84	639		0	1770	N	RMI	BNA	0	0	0	FRAG	1991 S
266	559	C	3	63	143	698		0	1770	N	CERAMICA	INFORME	0	0	0		1991 S
266	559	C	3	64	179	606		0	1772	P	QUARS	BNA	0	0	0		1991 S
266	559	C	3	65	22	681		0	1775	NE	CERAMICA	VORA	0	0	0	MAMELLO	1991 S
266	559	C	3	66	414	504		0	1782	SW	CERAMICA	INFORME	0	0	0		1991 S
266	559	C	3	67	27	403	1613	1770		W	CONGLOME	BNA	0	0	0	FRAG	1991 S
266	559	C	3	68	113	65		0	1778	W	CERAMICA	INFORME	0	0	0		1991 S

01/28/92

BOBILA MADURELL  
MAS DURAN  
Objectes Coordenats C5  
Campanya 1991

c	c	C	N											ALTERACIONS			P	D			
uX	uY	O	I	NUM.	X	Y	Zsup	Zinf	ORIENT	PENDENT	MATERIA	OBJECTE	LONG	AMPL	ESPE	OBSERVACIONS	ANY	U	I		
a	a	N	V																	N	B
d	d	J																		T	U
266	559	C	3	69	159	94	0	1768	P		CERAMICA	INFORME	0	0	0		1991	S			
266	559	C	3	70	152	31	0	1803	S		CERAMICA	INFORME	0	0	0	2 FRAGS	1991	S			
266	559	C	3	71	317	34	0	1802	S		CERAMICA	INFORME	0	0	0		1991	S			
266	559	C	3	72	212	173	0	1820	V		CALCARIA	BNA	0	0	0	FRAG	1991	S			
266	559	C	3	73	307	47	0	1845	NE		CERAMICA	INFORME	0	0	0		1991	S			
266	559	C	3	74	633	504	0	1929			ORGANIC	CARBO	0	0	0		1991	S			
266	559	C	3	75	153	604	0	1948	N		QUARS	BNA	0	0	0	FRAC	1991	S			
266	559	C	3	76	117	77	0	2015	V		CALCARIA	BNA	0	0	0	FRAC	1991	S			
266	559	C	3	77	23	43	0	2040	P		CERAMICA	INFORME	0	0	0		1991	S			
266	559	C	3	78	66	71	0	2054	E		CERAMICA	INFORME	0	0	0		1991	S			
266	559	C	3	79	260	83	0	2061	P		SORRENCA	BNA	0	0	0		1991	S			
266	559	C	3	80	332	129	0	2066	S		CERAMICA	INFORME	0	0	0		1991	S			
266	559	C	3	81	154	195	0	2038	P		RMI	BPF	0	0	0		1991	S			
266	559	C	3	82	188	186	0	2044	P		CERAMICA	INFORME	0	0	0		1991	S			
266	559	C	3	83	51	176	0	2051	N		SORRENCA	BNA	0	0	0	FRAG	1991	S			
266	559	C	3	84	114	41	0	2083	E		RMI	BNA	0	0	0		1991	S			
266	559	C	3	85	202	182	0	2078	P		CERAMICA	INFORME	0	0	0		1991	S			
266	559	C	3	86	153	187	0	2046	NW		CERAMICA	INFORME	0	0	0		1991	S			
266	559	C	3	87	74	172	0	2055	NE		SORRENCA	BNA	0	0	0	FRAG	1991	S			
266	559	C	3	88	312	28	0	2111	P		OS	INDET	0	0	0		1991	S			
266	559	C	3	89	130	4	0	2122	P		RMI	BNA	0	0	0	FRAG	1991	S			
266	559	C	3	90	155	134	0	2124	S		RMI	BNA	0	0	0	FRAG	1991	S			
266	559	C	3	91	17	129	0	2062	P		CALCARIA	BPF	0	0	0		1991	S			
266	559	C	3	92	380	34	0	2149	N		CALCARIA	BNA	0	0	0	FRAC	1991	S			
266	559	C	3	93	354	96	0	2147	E		CONGLOME	BNA	0	0	0	FRAG	1991	S			
266	559	C	3	94	636	352	0	1962	W		SORRENCA	BNA	0	0	0	FRAG	1991	S			
266	559	C	3	95	240	473	0	2001	S		CERAMICA	VORA	0	0	0		1991	S			
266	559	C	3	96	660	395	0	2032	V		SILEX	BNA	0	0	0	FRAC	1991	S			
266	559	C	3	97	542	271	0	2026	N		QUARS	BNA	0	0	0	FRAC	1991	S			
266	559	C	3	98	557	359	0	2039	V		RMI	BNA	0	0	0	FRAG LATERAT	1991	S			
266	559	C	3	99	296	603	0	2029	V		CONGLOME	BNA	0	0	0		1991	S			
266	559	C	3	100	113	675	1929	2033	P		CALCARIA	BNA	0	0	0		1991	S			
266	559	C	3	101	74	592	0	2060	S		CALCARIA	BNA	0	0	0	ALTERAT	1991	S			
266	559	C	3	102	221	589	0	2066	E		RMI	BNA	0	0	0	FRAG	1991	S			
266	559	C	3	103	506	305	0	2072	P		CONGLOME	BNA	0	0	0	FRAG MICROCONGL	1991	S			
266	559	C	3	104	276	325	0	2081	W		CERAMICA	INFORME	0	0	0		1991	S			
266	559	C	3	105	346	435	0	2055	S		RMI	BNA	0	0	0	FRAG	1991	S			
266	559	C	3	106	127	536	0	2064	NE		QUARS	BNA	0	0	0	FRAG	1991	S			
266	559	C	3	107	9	439	0	2069	SW		CERAMICA	INFORME	0	0	0		1991	S			
266	559	C	3	108	290	421	0	2084			CERAMICA	INFORME	0	0	0		1991	S			
266	559	C	3	109	193	443	0	2071	P		CERAMICA	INFORME	0	0	0	VARIS FRAGS	1991	S			
266	559	C	3	110	297	481	0	2084	P		RMI	BNA	0	0	0	FRAG	1991	S			
266	559	C	3	111	82	639	0	2076	S		OS	DET	0	0	0	MPa	1991	S			
266	559	C	3	112	251	143	0	2124	S		RMI	BNA	0	0	0	FRAG	1991	S			
266	559	C	3	113	144	395	0	2141			CALCARIA	BNA	0	0	0	FRAG ALTERAT	1991	S			
266	559	C	3	114	63	444	0	2121	E		RMI	BPF	0	0	0		1991	S			
266	559	C	3	115	361	445	0	2126	S		RMI	BNA	0	0	0	FRAG	1991	S			
266	559	C	3	116	44	275	0	2156	N		RMI	BNA	0	0	0	FRAG	1991	S			
266	559	C	3	117	54	48	0	2282	P		CALCARIA	BNA	0	0	0		1991	S			
267	554	C		1	70	929	0	1520	N-S	S	QUARS	BNA	0	0	0		1991	S			

137





01/28/92

BOBILA MADURELL  
MAS DURAN  
Objectes Coordenats C5  
Campanya 1991

c	c	C	N											ALTERACIONS	P	D			
uX	uY	O	I	NUM.	X	Y	Zsup	Zinf	ORIENT	PENDENT	MATERIA	OBJECTE	LONG	AMPL	ESPE	OBSERVACIONS	ANY	U	I
a	a	N	V															N	B
d	d	J																T	U
267	555	C	2	82	321	999	1510	1528	NW-SE	S	RMI	BNA	0	0	0	FRAG	1991	S	
267	555	C	2	83	25	901	1494	1537	N-S	P	QUARS	BNA	0	0	0	FRAG	1991	S	
267	555	C	2	84	19	616	0	1515		S	RMI	BNA	0	0	0	FRAG	1991	S	
267	555	C	3	85	16	314	0	1525		E	GRANIT	BNA	0	0	0	FRAG	1991	S	
267	555	C	3	86	513	967	0	1510		W	RMI	BNA	0	0	0	FRAG	1991	S	
267	555	C	2	87	78	553	0	1555		V	CERAMICA	INFORME	0	0	0		1991	S	
267	555	C	2	88	14	410	0	1565		P	RMI	BNA	0	0	0	FRAG	1991	S	
267	555	C	3	89	819	709	0	1570			SILEX	BP	0	0	0		1991	S	
267	555	C	3	90	948	701	0	1545		S	CERAMICA	INFORME	0	0	0		1991	S	
267	555	C	3	91	599	408	0	1575		SE	QUARS	BNA	0	0	0	FRAG	1991	S	
267	555	C	3	92	800	849	0	1586		SW	CERAMICA	INFORME	0	0	0		1991		
267	555	C	2	93	205	839	0	1610			QUARS	BNA	0	0	0		1991	S	
267	555	C	3	94	931	561	0	1605		S	CERAMICA	VORA	0	0	0	FRAGMENTADA	1991	S	
267	555	C	3	95	763	539	0	1626			CERAMICA	INFORME	0	0	0	TERRACUJITA	1991	S	
267	555	C	3	96	667	581	0	1617		P	CERAMICA	INFORME	0	0	0	TERRACUJITA	1991	S	
267	555	C	3	97	470	867	0	1615		SE	RMI	BNA	0	0	0	FRAG	1991	S	
267	555	C	3	98	423	216	0	1624		P	INDET	BNA	0	0	0	FRAG ALTERAT	1991	S	
267	555	C	3	99	600	582	0	1636		P	ESQUIST	BNA	0	0	0		1991	S	
267	555	C	3	100	426	687	1540	1650		S	SORRENCA	BNA	0	0	0	FRAG NO RECUPER	1991	S	
267	555	C	2	102	52	765	0	1651		E	QUARS	BNA	0	0	0	FRAG	1991	S	
267	555	C	3	103	694	796	0	1641			QUARS	BP	0	0	0		1991	S	
267	555	C	3	104	653	836	0	1665		S	CERAMICA	INFORME	0	0	0		1991	S	
267	555	C	3	105	513	767	0	1670		S	CERAMICA	INFORME	0	0	0	INFLEXIO	1991	S	
267	555	C	3	106	414	788	0	1660		S	CERAMICA	INFORME	0	0	0		1991	S	
267	555	C	3	107	516	813	0	1670		S	QUARS	BNA	0	0	0	FRAG NO RECUPER	1991	S	
267	555	C	3	108	740	528	0	1654		N	SORRENCA	BNA	0	0	0	FRAG NO RECUPER	1991	S	
267	555	C	3	109	807	413	0	1662		V	CALCARIA	BNA	0	0	0	FRAG NO RECUPER	1991	S	
267	555	C	3	110	654	353	0	1670		S	QUARS	BNA	0	0	0	FRAG NO RECUPER	1991	S	
267	555	C	3	111	579	692	0	1682		S	SORRENCA	BNA	0	0	0	FRAG BNE?	1991	S	
267	555	C	3	112	531	503	0	1676		N	SORRENCA	BNA	0	0	0	FRAG NO RECUPER	1991	S	
267	555	C	3	113	709	361	0	1653		S	SORRENCA	BNA	0	0	0	FRAG NO RECUPER	1991	S	
267	555	C	3	114	206	582	0	1675		S	SORRENCA	BNA	0	0	0	FRAG NO RECUPER	1991	S	
267	555	C	3	115	179	491	0	1695		P	SORRENCA	BNA	0	0	0	FRAG NO RECUPER	1991	S	
267	555	C	3	116	61	877	0	1702		V	CALCARIA	BNA	0	0	0	FRAG NO RECUPER	1991	S	
267	555	C	3	117	576	396	0	1682		W	SORRENCA	BNA	0	0	0	FRAG NO RECUPER	1991	S	
267	555	C	3	118	564	440	0	1700		V	SORRENCA	BNA	0	0	0	FRAG NO RECUPER	1991	S	
267	555	C	3	119	620	510	0	1690		SW	OS	DET	0	0	0	MD	1991	S	
267	555	C	3	120	624	442	0	1715		S	INDET	BNA	0	0	0	FRAG NO RECUPER	1991	S	
267	555	C	3	121	435	453	0	1724		SW	SORRENCA	BNA	0	0	0	FRAG ALTERAT	1991	S	
267	555	C	3	122	291	405	0	1742		V	SORRENCA	FRAG	0	0	0	ALTERADA	1991		
267	555	C	3	123	251	354	0	1720		P	QUARS	BNA	0	0	0	NO RECUPERAT	1991	S	
267	555	C	3	124	276	832	0	1714		P	QUARS	BNA	0	0	0	FRAG NO RECUPER	1991	S	
267	555	C	3	125	858	332	0	1683		S	INDET	BNA	0	0	0	FRAG	1991	S	
267	555	C	3	126	968	199	0	1684		E	SORRENCA	BNA	0	0	0	FRAG NO RECUPER	1991	S	
267	555	C	3	127	342	283	0	1716		V	CONGLOME	BNA	0	0	0	FRAG NO RECUPER	1991	S	
267	555	C	3	128	360	375	0	1716		N	QUARS	BNA	0	0	0	FRAG NO RECUPER	1991	S	
267	555	C	3	129	213	371	0	1710		W	SORRENCA	BNA	0	0	0	FRAG	1991	S	
267	555	C	3	130	38	779	0	1717		E	SORRENCA	BNA	0	0	0	FRAG	1991	S	
267	555	C	3	131	897	194	0	1705		N	QUARS	BNA	0	0	0	FRAG	1991	S	
267	555	C	3	132	853	647	0	1701		S	CERAMICA	INFORME	0	0	0		1991	S	

BOBILA MADURELL  
MAS DURAN  
Objectes Coordenats C5  
Campanya 1991

c	c	C	N												ALTERACIONS			P	D
uX	uY	O	I	NUM.	X	Y	Zsup	Zinf	ORIENT	PENDENT	MATERIA	OBJECTE	LONG	AMPL	ESPE	OBSERVACIONS	ANY	U	I
a	a	N	V															N	B
d	d	J																T	U
267	555	c	3	133	706	807	0	1743	S		CERAMICA	INFORME	0	0	0		1991	S	
267	555	c	3	134	436	564	0	1722	S		SORRENCA	BNA	0	0	0	FRAG NO RECUPER	1991	S	
267	555	c	3	135	706	807	0	1725	S		CERAMICA	INFORME	0	0	0		1991	S	
267	555	c	3	136	392	423	0	1725	E		QUARS	BNA	0	0	0	FRAG NO RECUPER	1991	S	
267	555	c	3	137	84	388	0	1715	SE		SORRENCA	BNA	0	0	0	FRAG	1991	S	
267	555	c	3	138	71	351	0	1706			CERAMICA	INFORME	0	0	0	NO RECUPERAT	1991	S	
267	555	c	3	139	357	144	0	1706	SW		SORRENCA	BNA	0	0	0	FRAG NO RECUPER	1991	S	
267	555	c	3	140	850	500	0	1724	S		INDET	BNA	0	0	0	FRAG NO RECUPER	1991	S	
267	555	c	3	141	750	456	0	1724	N		CERAMICA	VORA	0	0	0		1991	S	
267	555	c	3	142	829	718	0	1723			CERAMICA	INFORME	0	0	0		1991	S	
267	555	c	3	143	368	433	0	1730	S		SORRENCA	BNA	0	0	0	NO RECUPER FRAG	1991	S	
267	555	c	3	144	412	255	0	1746	P		OS	DET	0	0	0	VT BOTA	1991	S	
267	555	c	3	145	811	77	0	1723	P		CERAMICA	INFORME	0	0	0		1991	S	
267	555	c	3	146	942	163	0	1762	P		CERAMICA	INFORME	0	0	0		1991	S	
267	555	c	3	147	654	350	0	1750	E		CERAMICA	INFORME	0	0	0		1991	S	
267	555	c	3	148	267	282	0	1750	P		CERAMICA	INFORME	0	0	0		1991	S	
267	555	c	3	149	828	467	0	1760	S		SORRENCA	BNA	0	0	0	FRAG	1991	S	
267	555	c	3	150	770	276	0	1770	P		CERAMICA	INFORME	0	0	0		1991	S	
267	555	c	3	151	549	153	0	1785			ORGANIC	CARBO	0	0	0		1991	S	
267	555	c	3	152	64	866	0	1778	S		SORRENCA	BNA	0	0	0	FRAG ALTERAT	1991	S	
267	555	c	3	153	19	524	0	1801	V		CALCARIA	BNA	0	0	0	FRAG ALTERAT	1991	S	
267	555	c	3	154	64	866	0	1796	P		SORRENCA	BNA	0	0	0	FRAG ALTERAT	1991	S	
267	555	c	3	155	19	524	0	1765	N		SORRENCA	BNA	0	0	0	FRAG NO RECUPER	1991	S	
267	555	c	3	156	212	116	0	1790	S		CERAMICA	INFORME	0	0	0	FRAGMENTAT	1991	S	
267	555	c	3	157	0	0	0	1774	NE		CERAMICA	APLICA	0	0	0	MUGRO	1991	S	
267	555	c	3	158	293	99	0	1800	P		CERAMICA	INFORME	0	0	0		1991	S	
267	555	c	3	159	604	15	0	1795	S		CERAMICA	INFORME	0	0	0		1991	S	
267	555	c	3	160	583	34	0	1796	S		CERAMICA	INFORME	0	0	0		1991	S	
267	555	c	3	161	655	15	0	1805	S		CERAMICA	INFORME	0	0	0		1991	S	
267	555	c	3	162	241	154	0	1800	E		SORRENCA	BNA	0	0	0	FRAG	1991	S	
267	555	c	3	163	267	605	0	1819	NW		SORRENCA	BNA	0	0	0	FRAG	1991	S	
267	555	c	3	164	720	770	0	1800	P		SILEX	BNA	0	0	0	FRAG	1991	S	
267	555	c	3	165	267	605	0	1875	P		CERAMICA	INFORME	0	0	0		1991	S	
267	555	c	3	166	720	770	0	1805	P		CALCARIA	BNA	0	0	0	FRAG ALTERAT	1991	S	
267	555	c	3	167	423	706	0	1840	W		RMI	BNA	0	0	0	FRAG	1991	S	
267	555	c	3	168	861	150	0	1811	S		CERAMICA	PANXA	0	0	0		1991	S	
267	555	c	3	169	268	235	0	1836	NW		RMI	BNE	0	0	0	ALTERAT	1991	S	
267	555	c	3	170	736	72	0	1798	SE		SORRENCA	BNA	0	0	0	FRAG ALTERAT	1991	S	
267	555	c	3	171	729	128	0	1789	SE		RMI	BNA	0	0	0	FRAG	1991	S	
267	555	c	3	172	502	410	0	1795	P		CONGLOME	BNA	0	0	0	FRAG	1991	S	
267	555	c	3	173	686	90	0	1800	E		CERAMICA	INFORME	0	0	0	ARRANCAMENT?	1991	S	
267	555	c	3	174	474	691	0	1865	SW		CALCARIA	BNA	0	0	0	FRAC CREMAT	1991	S	
267	555	c	3	175	55	675	0	1862	E		SORRENCA	BNA	0	0	0	FRAG CREMAT	1991	S	
267	555	c	3	176	259	955	0	1804	SE		CERAMICA	INFORME	0	0	0		1991	S	
267	555	c	3	177	444	983	0	1838	S		CERAMICA	INFORME	0	0	0		1991	S	
267	555	c	3	178	822	749	0	1849	NE		CERAMICA	PANXA	0	0	0		1991	S	
267	555	c	3	179	554	600	0	1867	NW		RMI	BNA	0	0	0	FRAG	1991	S	
267	555	c	3	180	75	471	0	1856	E		ESQUIST	BNA	0	0	0	FRAG	1991	S	
267	555	c	3	181	18	753	0	1866	E		CALCARIA	BNA	0	0	0	FRAG TERMOALTER	1991	S	
267	555	c	3	182	231	419	1774	1936	V		RMI	BNA	0	0	0		1991	S	



BOBILA MADURELL  
 MAS DURAN  
 Objectes Coordinats C5  
 Campanya 1991

c	c	C	N	NUM.	X	Y	Zsup	Zinf	ORIENT	PENDENT	MATERIA	OBJECTE	LONG	AMPL	ESPE	OBSERVACIONS	ALTERACIONS	P	D
uX	uY	O	I															ANY	U
a	a	N	V																I
d	d	J																	N
																			B
																			T
																			U
267	555	c	3	183	482	401	0	1892	SW	RMI	BNA		0	0	0	FRAG		1991	S
267	555	c	3	184	459	558	0	1899	NW	RMI	BNA		0	0	0			1991	S
267	555	c	3	185	576	497	0	1862	NW	CALCARIA	BNA		0	0	0			1991	S
267	555	c	3	186	646	659	1748	1877	W	RMI	BNA		0	0	0			1991	S
267	555	c	3	187	515	821	0	1900	SW	RMI	BNA		0	0	0	FRAG		1991	S
267	555	c	3	188	643	774	0	1920	V	RMI	BNA		0	0	0	FRAG		1991	S
267	555	c	3	189	369	845	0	1922	S	CONGLOME	BNA		0	0	0	MICROCONGLOME		1991	S
267	555	c	3	190	556	417	0	1846		ORGANIC	CARBO		0	0	0			1991	S
267	555	c	3	191	32	943	0	1925	NW	RMI	BNA		0	0	0	FRAG		1991	S
267	555	c	3	192	53	969	0	1929	NW	RMI	BNA		0	0	0	FRAG		1991	S
267	555	c	3	193	104	939	1858	1946	NW	RMI	BNA		0	0	0	FRAG		1991	S
267	555	c	3	194	192	980	0	1910	SW	RMI	BNA		0	0	0	FRAG		1991	S
267	555	c	3	195	459	851	0	1924	P	CALCARIA	BNA		0	0	0	FRAG ALTERAT		1991	S
267	555	c	3	196	701	791	0	1919	SE	SORRENCA	BNA		0	0	0			1991	S
267	555	c	3	197	454	769	0	1925	S	RMI	BNA		0	0	0	FRAG		1991	S
267	555	c	3	198	277	692	1802	1995	N	CONGLOME	BNA		0	0	0	FRAG ALTER BNE?		1991	S
267	555	c	3	199	384	715	0	1945	N	CALCARIA	BNA		0	0	0	FRAG ALTERAT		1991	S
267	555	c	3	200	372	645	0	1940	W	CONGLOME	BNA		0	0	0	MICROCONGLOME		1991	S
267	555	c	3	201	617	669	0	1916	NW	RMI	BNA		0	0	0	FRAG ALTERAT		1991	S
267	555	c	3	202	571	572	0	1929	NE	RMI	BNA		0	0	0	FRAG		1991	S
267	555	c	3	203	513	527	0	1924	W	RMI	BNA		0	0	0	FRAG ALTERAT		1991	S
267	555	c	3	204	21	975	0	1960	V	INDET	BNA		0	0	0	ALTERAT		1991	S
267	555	c	3	205	618	753	0	1956	S	SORRENCA	BNA		0	0	0	FRAG ALTERAT		1991	S
267	555	c	3	206	249	734	0	1951	P	INDET	BNA		0	0	0	FRAG ALTERAT		1991	S
267	555	c	3	207	290	668	0	1977	SE	INDET	BNA		0	0	0	FRAG ALTERAT		1991	S
267	555	c	3	208	550	695	0	1959	SE	CONGLOME	BNA		0	0	0	ALTERAT MICROCG		1991	S
267	555	c	3	209	655	684	0	1937	N	RMI	BNA		0	0	0	FRAG ALTERAT		1991	S
267	555	c	3	210	460	656	0	1940	W	CALCARIA	BP		0	0	0			1991	S
267	555	c	3	211	420	662	0	1962	SW	INDET	BNA		0	0	0	FRAG ALTERAT		1991	S
267	555	c	3	212	135	931	0	1977	SW	CALCARIA	BNA		0	0	0	FRAG ALTERAT		1991	S
267	555	c	3	213	446	749	0	1961	P	CALCARIA	BNA		0	0	0	FRAG ALTERAT		1991	S
267	555	c	3	214	478	676	0	1957	P	RMI	BNA		0	0	0			1991	S
267	555	c	3	215	298	685	0	1982	E	CALCARIA	BNA		0	0	0	FRAG ALTERAT		1991	S
267	555	c	3	216	231	685	0	1978	E	CALCARIA	BNA		0	0	0	FRAG ALTERAT		1991	S
267	555	c	3	217	227	602	0	1973	E	CALCARIA	BNA		0	0	0	FRAG ALTERAT		1991	S
267	555	c	3	218	200	936	0	1945	V	CALCARIA	BNA		0	0	0	FRAG ALTERAT		1991	S
267	555	c	3	219	292	989	0	1926	SW	RMI	BNA		0	0	0	ALTERAT		1991	S
267	555	c	3	221	383	933	0	1956	SE	RMI	BNA		0	0	0	FRAG ALTERAT		1991	S
267	555	c	3	222	748	910	0	1905	W	CALCARIA	BNA		0	0	0			1991	S
267	555	c	3	223	107	802	0	1950	SW	RMI	BNA		0	0	0	FRAG ALTERAT		1991	S
267	555	c	3	224	193	823	0	1952	SE	RMI	BNA		0	0	0	FRAG ALTERAT		1991	S
267	555	c	3	225	100	713	0	1938	SE	SORRENCA	BNA		0	0	0	ALTERAT		1991	S
267	555	c	3	226	6	710	0	1974	S	RMI	BNA		0	0	0	FRAG ALTERAT		1991	S
267	555	c	3	227	33	529	0	1942	P	ORGANIC	CARBO		0	0	0			1991	S
267	555	c	3	228	107	656	0	1953	S	RMI	BNA		0	0	0	FRAG ALTERAT		1991	S
267	555	c	3	229	19	737	0	0	P	ORGANIC	CARBO		0	0	0			1991	S
267	555	c	3	230	518	92	0	1882	E	RMI	BNA		0	0	0	FRAG		1991	S
267	555	c	3	231	814	99	0	1870	SW	CERAMICA	INFORME		0	0	0			1991	S
267	555	c	3	232	730	25	0	1876	P	RMI	BNA		0	0	0			1991	S
267	556	c		1	474	691	0	1235	P	CONGLOME	BNA		0	0	0	MICROCONGL FRAG		1991	S

BOBILA MADURELL  
MAS DURAN  
Objectes Coordenats C5  
Campanya 1991

c	c	C	N											ALTERACIONS			P	D			
uX	uY	O	I	NUM.	X	Y	Zsup	Zinf	ORIENT	PENDENT	MATERIA	OBJECTE	LONG	AMPL	ESPE	OBSERVACIONS	ANY	U	I		
a	a	N	V																	N	B
d	d	J																		T	U
267	556	c		2	55	675	1181	1234		NW	CONGLOME	BNA	0	0	0	MICROCONGL	FRAG	1991	S		
267	556	c		3	247	325	0	1226		W	QUARS	BNA	0	0	0	FRAG		1991	S		
267	556	c		4	179	343	0	1236		NW	QUARS	BNA	0	0	0	FRAC		1991	S		
267	556	c		5	510	307	0	1232			SORRENCA	BNA	0	0	0	FRAG		1991	S		
267	556	c		6	955	380	1194	1291		P	CALCARIA	BNA	0	0	0	CREMADA		1991	S		
267	556	c		7	649	936	1198	1258		N	RMI	BNA	0	0	0	FRAG		1991	S		
267	556	c		8	252	987	0	1229			CONGLOME	FRAG	0	0	0	MICROCONGLOME		1991	S		
267	556	c	2	9	85	880	0	1276		P	RMI	BNA	0	0	0			1991	S		
267	556	c	2	10	230	966	0	1230		NE	RMI	BNA	0	0	0	FRAG		1991	S		
267	556	c	2	11	368	273	0	1312			CALCARIA	BNA	0	0	0	FRAG		1991	S		
267	556	c	2	12	67	237	0	1311			CERAMICA	INFORME	0	0	0			1991	S		
267	556	c	2	13	325	632	0	1306	NW-SE	NW	CALCARIA	CODOLF	0	0	0			1991	S		
267	556	c	2	14	305	687	1150	1284	NW-SE		GRANIT	BNA	0	0	0			1991	S		
267	556	c	2	15	207	635	0	1264	NW-SE	P	QUARS	FRAG	0	0	0			1991	S		
267	556	c	2	16	204	768	0	1265	NW-SE	W	SORRENCA	BNA	0	0	0	ALTERAT		1991	S		
267	556	c	2	17	422	823	0	1250	NW-SE	N	CERAMICA	INFORME	0	0	0			1991	S		
267	556	c	2	18	204	861	0	1257	NE-SW		QUARS	CODOL	0	0	0			1991	S		
267	556	c	2	19	939	705	0	1266	NE-SW	NE	SORRENCA	CODOL	0	0	0			1991	S		
267	556	c	2	20	950	628	0	1256	N-S	N	CERAMICA	INFORME	0	0	0			1991	S		
267	556	c	2	21	818	92	0	1280		S	QUARS	FRAG	0	0	0			1991	S		
267	556	c	2	22	610	158	0	1297	N-S	S	CALCARIA	CODOLF	0	0	0			1991	S		
267	556	c	2	23	386	72	1170	1287		S	CALCARIA	FRAG	0	0	0			1991	S		
267	556	c	2	24	289	38	1200	1290		S	RMI	BNA	0	0	0	FRAG		1991	S		
267	556	c	2	25	952	306	1254	1285	NW-SE	P	CALCARIA	FRAG	0	0	0			1991	S		
267	556	c	2	26	343	834	0	1244	NW-SE	P	CALCARIA	FRAG	0	0	0			1991	S		
267	556	c	2	27	477	799	0	1272	E-W	P	CERAMICA	INFORME	0	0	0			1991	S		
267	556	c	2	28	639	807	0	1261	N-S	P	CALCARIA	FRAG	0	0	0			1991	S		
267	556	c	2	29	314	956	0	1297			CERAMICA	INFORME	0	0	0			1991	S		
267	556	c	2	30	506	977	0	1323			CERAMICA	INFORME	0	0	0			1991	S		
267	556	c	2	31	816	908	1294	1310	N-S	P	CALCARIA	FRAG	0	0	0			1991	S		
267	556	c	2	32	486	48	0	1322			CERAMICA	INFORME	0	0	0			1991	S		
267	556	c	2	33	511	925	0	1314			SORRENCA	FRAG	0	0	0			1991	S		
267	556	c	2	34	238	237	0	1330			CERAMICA	INFORME	0	0	0			1991	S		
267	556	c	2	35	243	143	0	1324			SORRENCA	FRAG	0	0	0			1991	S		
267	556	c	2	36	965	761	0	1279			SORRENCA	CODOL	0	0	0			1991	S		
267	556	c	2	37	344	133	0	1328			CALCARIA	BNA	0	0	0	ALTERAT		1991	S		
267	556	c	2	38	385	192	0	1328			SORRENCA	FRAG	0	0	0			1991	S		
267	556	c	2	39	446	485	0	1322			SORRENCA	CODOLF	0	0	0			1991	S		
267	556	c	2	40	520	414	0	1322			CALCARIA	FRAG	0	0	0			1991	S		
267	556	c	2	41	561	614	0	1327			SORRENCA	FRAG	0	0	0			1991	S		
267	556	c	2	42	689	519	0	1327			QUARS	FRAG	0	0	0			1991	S		
267	556	c	2	43	754	605	0	1305			SORRENCA	FRAG	0	0	0			1991	S		
267	556	c	2	44	843	501	0	1284			SORRENCA	FRAG	0	0	0			1991	S		
267	556	c	2	45	860	565	0	1284			CERAMICA	INFORME	0	0	0			1991	S		
267	556	c	2	46	859	623	0	1318			SORRENCA	FRAG	0	0	0			1991	S		
267	556	c	2	47	735	909	0	1296			SORRENCA	FRAG	0	0	0			1991	S		
267	556	c	2	48	769	815	0	1296			QUARS	FRAG	0	0	0			1991	S		
267	556	c	2	49	812	875	0	1296			QUARS	FRAG	0	0	0			1991	S		
267	556	c	2	51	946	802	0	1294			SORRENCA	BNA	0	0	0			1991	S		
267	556	c	2	52	819	951	0	1296			CERAMICA	INFORME	0	0	0	2 FRAGS		1991	S		

143



BOBILA MADURELL  
MAS DURAN  
Objectes Coordenats C5  
Campanya 1991

c	c	C	N											ALTERACIONS	P	D			
uX	uY	O	I	NUM.	X	Y	Zsup	Zinf	ORIENT	PENDENT	MATERIA	OBJECTE	LONG	AMPL	ESPE	OBSERVACIONS	ANY	U	I
a	a	N	V															N	B
d	d	J																T	U
267	556	C	2	106	928	198	0	1390	NW-SE	NW	CERAMICA	INFORME	0	0	0		1991	S	
267	556	C	2	107	927	170	0	1382	N-S	N	CERAMICA	INFORME	0	0	0	VARIS FRAGS.	1991	S	
267	556	C	2	109	942	25	0	1379			CERAMICA	INFORME	0	0	0		1991	S	
267	556	C	2	110	938	53	0	1385			CERAMICA	INFORME	0	0	0		1991	S	
267	556	C	2	111	980	70	0	1374			CERAMICA	INFORME	0	0	0		1991	S	
267	556	C	2	112	978	116	0	1370			CERAMICA	INFORME	0	0	0		1991	S	
267	556	C	2	113	980	147	0	1380			CERAMICA	INFORME	0	0	0		1991	S	
267	556	C	2	114	919	126	0	1382			CERAMICA	INFORME	0	0	0		1991	S	
267	556	C	2	115	825	269	0	1397			CERAMICA	INFORME	0	0	0		1991	S	
267	556	C	2	116	582	505	0	1390	N-S	E	SILEX	BPF	0	0	0		1991	S	
267	556	C	2	117	128	661	1350	1370	E-W	SE	QUARS	BNA	0	0	0	FRAG	1991	S	
267	556	C	2	118	128	661	0	1382	NW-SE	SE	SORRENCA	BNA	0	0	0	FRAG	1991	S	
267	556	C	2	119	299	764	1336	1380	NW-SE	SE	CALCARIA	BNA	0	0	0	FRAG	1991	S	
267	556	C	2	120	473	607	0	1389	N-S	NW	SORRENCA	BNA	0	0	0	FRAG	1991	S	
267	556	C	2	121	494	638	1330	1380	NW-SE	NW	SORRENCA	BNA	0	0	0	FRAG	1991	S	
267	556	C	2	122	678	751	0	1355	N-S	NW	ESQUIST	BNA	0	0	0	FRAG	1991	S	
267	556	C	2	123	693	711	0	1365			CERAMICA	INFORME	0	0	0		1991	S	
267	556	C	2	124	859	944	1312	1339	N-S	SE	QUARSITA	BNA	0	0	0	FRAG	1991	S	
267	556	C	2	125	153	866	0	1382	NW-SE	P	INDET	BNA	0	0	0	FRAG	1991	S	
267	556	C	2	126	286	876	1304	1389	NW-SE	S	QUARS	BNA	0	0	0		1991	S	
267	556	C	2	127	304	930	1336	1400	NW-SE	SW	INDET	CODOL	0	0	0		1991	S	
267	556	C	2	128	238	818	0	1380	N-S	S	RMI	BNA	0	0	0	FRAG	1991	S	
267	556	C	2	129	216	725	0	1378		P	QUARS	BPF	0	0	0		1991	S	
267	556	C	2	130	381	788	0	1375	NW-SE	P	QUARS	CODOLF	0	0	0		1991	S	
267	556	C	2	131	383	720	0	1390	NE-SW	SW	QUARSITA	BNA	0	0	0	FRAG	1991	S	
267	556	C	2	132	450	834	1325	1383	N-S	SW	RMI	BNA	0	0	0	FRAG	1991	S	
267	556	C	2	133	480	790	0	1374	N-S	V	CERAMICA	INFORME	0	0	0	TERRA CUITA	1991	S	
267	556	C	2	134	480	725	1320	1394	NW-SE	V	RMI	BNA	0	0	0	FRAG	1991	S	
267	556	C	2	135	642	761	0	1373	NW-SE	P	RMI	BNA	0	0	0	FRAG	1991	S	
267	556	C	2	136	521	621	1349	1406	E-W	SW	CALCARIA	BP	0	0	0		1991	S	
267	556	C	2	137	9	650	0	1396	NE-SW	NE	CERAMICA	INFORME	0	0	0		1991	S	
267	556	C	2	138	46	551	0	1399	NW-SE	V	QUARSITA	BN1G	0	0	0		1991	S	
267	556	C	2	139	61	501	0	1398	N-S	V	QUARSITA	BNA	0	0	0		1991	S	
267	556	C	2	140	852	249	0	1395			RMI	BNA	0	0	0	FRAG	1991	S	
267	556	C	2	141	77	243	0	1404	NE-SW		RMI	BNA	0	0	0	FRAG	1991	S	
267	556	C	2	142	167	259	1367	1405	E-W	V	RMI	BNA	0	0	0	FRAG	1991	S	
267	556	C	2	143	131	517	0	1393			RMI	BNA	0	0	0	FRAG	1991	S	
267	556	C	2	144	861	254	0	1400	NW-SE	NW	CONGLOME	BNA	0	0	0	FRAG MICROCONGL	1991	S	
267	556	C	2	145	799	416	0	1410	E-W	V	QUARS	BNA	0	0	0		1991	S	
267	556	C	2	146	861	254	0	1385	N-S	S	RMI	BNA	0	0	0	FRAG	1991	S	
267	556	C	2	147	814	646	0	1375	N-S	S	RMI	BNA	0	0	0	FRAG	1991	S	
267	556	C	2	148	542	758	0	1395	N-S	NW	QUARS	BNA	0	0	0	FRAG	1991	S	
267	556	C	2	149	191	723	0	1410	E-W	SE	CERAMICA	VORA	0	0	0		1991	S	
267	556	C	2	150	741	965	0	1340	E-W	V	CALCARIA	BNA	0	0	0	FRAG	1991	S	
267	556	C	2	151	610	953	1340	1385	N-S	S	QUARS	BNA	0	0	0	FRAC	1991	S	
267	556	C	2	152	294	311	0	1415	E-W	NE	CERAMICA	INFORME	0	0	0		1991	S	
267	556	C	2	153	317	206	0	1430	N-S	NW	QUARS	BNA	0	0	0	FRAG	1991	S	
267	556	C	2	154	535	146	0	1420	E-W	SE	CERAMICA	INFORME	0	0	0		1991	S	
267	556	C	2	155	555	333	0	1430	E-W	E	CERAMICA	INFORME	0	0	0		1991	S	
267	556	C	2	156	659	505	0	1420	N-S	S	CALCARIA	BNA	0	0	0	CREMAT	1991	S	

145

BOBILA MADURELL  
MAS DURAN  
Objectes Coordenats C5  
Campanya 1991

c	c	C	N	NUM.	X	Y	Zsup	Zinf	ORIENT	PENDENT	MATERIA	OBJECTE	LONG	AMPL	ESPE	OBSERVACIONS	ALTERACIONS	P	D
267	556	c	2	157	640	595	0	1406	N-S	NE	GRANIT	BNA	0	0	0	FRAG		1991	S
267	556	c	2	158	747	706	0	1405	N-S	P	CONGLOME	BNA	0	0	0	FRAG MICROCONGL		1991	S
267	556	c	2	159	753	79	0	1412	NW-SE	S	SORRENCA	BNA	0	0	0	ALTERAT		1991	S
267	556	c	2	160	706	96	1401	1433	NW-SE	P	SORRENCA	BNA	0	0	0			1991	S
267	556	c	2	161	651	136	1385	1423	N-S	P	RMI	BNA	0	0	0	FRAG		1991	S
267	556	c	2	162	665	191	1405	1432	E-W	P	CERAMICA	INFORME	0	0	0			1991	S
267	556	c	2	163	692	195	0	1428	E-W	P	CERAMICA	INFORME	0	0	0	VARIS FRAGS		1991	S
267	556	c	2	164	703	168	0	1437	E-W	P	CERAMICA	INFORME	0	0	0	VARIS FRAGS		1991	S
267	556	c	2	165	717	146	0	1415	E-W	P	CERAMICA	INFORME	0	0	0			1991	S
267	556	c	2	166	742	124	0	1401	E-W	P	SORRENCA	BNA	0	0	0	FRAG		1991	S
267	556	c	2	167	602	40	0	1430	N-S	V	CERAMICA	INFORME	0	0	0	TERRACUITA		1991	S
267	556	c	2	168	623	36	0	1467	E-W	P	CERAMICA	INFORME	0	0	0	ARGILA CUITA		1991	S
267	556	c	2	169	641	28	0	1456	E-W	P	SORRENCA	BNA	0	0	0	FRAG		1991	S
267	556	c	2	170	679	12	0	1448			CERAMICA	INFORME	0	0	0	NO RECUPERAT		1991	S
267	556	c	2	171	964	303	1350	1430	E-W	P	RMI	BNA	0	0	0			1991	S
267	556	c	2	172	826	305	1385	1419	E-W	W	SORRENCA	BNA	0	0	0	FRAG		1991	S
267	556	c	2	173	863	352	1367	1410	NW-SE	SW	SORRENCA	BNA	0	0	0	FRAG		1991	S
267	556	c	2	174	823	409	1375	1400	NW-SE	SW	SORRENCA	BNA	0	0	0	FRAG		1991	S
267	556	c	2	175	778	448	1390	1433	E-W	P	CONGLOME	BNA	0	0	0	FRAG MICROCONGL		1991	S
267	556	c	2	176	624	438	1379	1466	N-S	P	RMI	BNA	0	0	0	FRAG		1991	S
267	556	c	2	178	610	317	1100	1132	E-W	P	CALCARIA	BNA	0	0	0	FRAG		1991	S
267	556	c	2	179	535	345	1395	1443	NE-SW	S	QUARS	BNA	0	0	0	FRAG		1991	S
267	556	c	2	180	439	414	1410	1437	E-W	P	SORRENCA	BNA	0	0	0			1991	S
267	556	c	2	181	513	448	1401	1430	NW-SE	SE	RMI	BNA	0	0	0	FRAG		1991	S
267	556	c	2	182	607	641	0	1406	NE-SW	NE	CERAMICA	INFORME	0	0	0			1991	S
267	556	c	2	183	511	810	1370	1414	NE-SW	SW	SORRENCA	BNA	0	0	0	FRAG		1991	S
267	556	c	2	184	209	916	1391	1410	NW-SE	E	SORRENCA	BNA	0	0	0	FRAG		1991	S
267	556	c	2	185	161	973	1380	1419	N-S	S	QUARSITA	BNA	0	0	0	FRAG		1991	S
267	556	c	2	186	71	965	1394	1415	NE-SW	SW	SORRENCA	BNA	0	0	0	FRAG		1991	S
267	556	c	2	187	692	295	1395	1435	N-S	S	SORRENCA	BNA	0	0	0	FRAG		1991	S
267	556	c	2	188	862	584	1385	1433	N-S	S	SORRENCA	BNA	0	0	0	FRAG		1991	S
267	556	c	2	189	862	584	1390	1423	E-W	P	QUARS	BNA	0	0	0	FRAG		1991	S
267	556	c	2	190	568	123	1425	1460	NW-SE	SE	QUARS	BNA	0	0	0	FRAG		1991	S
267	556	c	2	191	127	20	1415	1435	N-S	S	CALCARIA	BNA	0	0	0	ALTERAT		1991	S
267	556	c	2	192	692	73	1422	1450	E-W	P	QUARS	BNA	0	0	0	FRAG		1991	S
267	556	c	2	193	739	104	1426	1443	NW-SE	P	ESQUIST	BNA	0	0	0	FRAG		1991	S
267	556	c	2	194	786	132	0	1418		P	CERAMICA	INFORME	0	0	0			1991	S
267	556	c	2	195	749	167	0	1435	E-W	P	CERAMICA	INFORME	0	0	0	VARIS FRAGS		1991	S
267	556	c	2	196	803	179	0	1423		P	CERAMICA	INFORME	0	0	0			1991	S
267	556	c	2	197	874	235	1400	1442	E-W	P	QUARSITA	BNA	0	0	0	FRAG		1991	S
267	556	c	2	198	908	208	0	1416	E-W	P	CERAMICA	APLICA	0	0	0	MUGRO		1991	S
267	556	c	2	199	959	188	0	1406	E-W	P	CERAMICA	INFORME	0	0	0	VARIS FRAGS		1991	S
267	556	c	2	200	148	350	1447	1477	N-S	P	CONGLOME	BNA	0	0	0	FRAG MICROCONGL		1991	S
267	556	c	2	201	162	130	0	1465	NE-SW	S	CERAMICA	INFORME	0	0	0			1991	S
267	556	c	2	202	210	182	1442	1456	NE-SW	P	CALCARIA	FRAG	0	0	0			1991	
267	556	c	2	203	245	54	1443	1480	N-S	P	CALCARIA	FRAG	0	0	0			1991	
267	556	c	2	204	352	93	0	1460	NE-SW	P	CONGLOME	BNA	0	0	0	MICROCONGLOME		1991	S
267	556	c	2	205	269	366	0	1440	N-S	P	CALCARIA	BP	0	0	0			1991	S
267	556	c	2	206	693	208	0	1438		P	SORRENCA	BNA	0	0	0	FRAG		1991	S
267	556	c	2	207	799	157	0	1450		P	CERAMICA	INFORME	0	0	0			1991	S

01/28/92

BOBILA MADURELL  
MAS DURAN  
Objectes Coordenats C5  
Campanya 1991

c	c	C	N										ALTERACIONS			P	D				
uX	uY	O	I	NUM.	X	Y	Zsup	Zinf	ORIENT	PENDENT	MATERIA	OBJECTE	LONG	AMPL	ESPE	OBSERVACIONS	ANY	U	I		
a	a	N	V																		
d	d	J	J																N	B	
																				T	U
267	556	C		208	831	142	0	1445	W		CERAMICA VORA		0	0	0		1991	S			
267	556	C		209	909	273	0	1450	P		CALCARIA BNA		0	0	0		1991	S			
267	556	C		210	900	368	0	1452	P		SORRENCA BNA		0	0	0		1991	S			
267	556	C		211	841	383	0	1455	NE-SW	S	CERAMICA INFORME		0	0	0		1991	S			
267	556	C		212	875	467	0	1423			CERAMICA INFORME		0	0	0		1991	S			
267	556	C		213	861	505	0	1423	P		CERAMICA INFORME		0	0	0		1991	S			
267	556	C		214	832	538	1412	1434	P		RMI BNA		0	0	0	FRAG	1991	S			
267	556	C		215	767	534	1411	1450	NE-SW	SW	CALCARIA BNA		0	0	0	FRAG	1991	S			
267	556	C		216	655	605	1414	1429	N-S	S	RMI BNA		0	0	0	FRAG	1991	S			
267	556	C		217	502	762	0	1455	P		CALCARIA FRAG		0	0	0		1991	S			
267	556	C		218	388	556	1438	1455	E-W	W	CERAMICA INFORME		0	0	0	2 FRAGS	1991	S			
267	556	C		219	149	965	0	1430	P		CERAMICA INFORME		0	0	0		1991	S			
267	556	C		220	85	966	0	1424			SORRENCA FRAG		0	0	0		1991	S			
267	556	C		221	398	26	0	1462	N-S	P	SORRENCA BNA		0	0	0	FRAG	1991	S			
267	556	C	2	222	231	20	0	1490	N		RMI BNA		0	0	0		1991	S			
267	556	C	2	223	701	203	0	1477	NW		SORRENCA BNA		0	0	0	FRAG ALTERAT	1991	S			
267	556	C	2	224	352	459	0	1489	N		CERAMICA INFORME		0	0	0	ARGILA CUITA	1991	S			
267	556	C	2	225	660	839	0	1477	W		CONGLOME BNA		0	0	0	FRAG MICROCONGL	1991	S			
267	556	C	2	226	613	981	0	1455	V		SORRENCA BNA		0	0	0	FRAG	1991	S			
267	556	C	2	227	557	24	0	1498	P		SORRENCA BNA		0	0	0	FRAG	1991	S			
267	556	C	2	228	799	136	0	1463	P		QUARSITA BNA		0	0	0		1991	S			
267	556	C	2	229	672	143	0	1484	E		CERAMICA INFORME		0	0	0		1991	S			
267	556	C	2	230	664	360	0	1516	N		SORRENCA BNA		0	0	0	FRAG	1991	S			
267	556	C	2	231	631	557	0	1508	E		SORRENCA BNA		0	0	0	FRAG	1991	S			
267	556	C	2	232	492	714	0	1492	E		INDET BNA		0	0	0	FRAG	1991	S			
267	556	C	2	233	436	695	0	1494	NE		CONGLOME BNA		0	0	0		1991	S			
267	556	C	2	234	551	263	0	1510	V		QUARS BNA		0	0	0	FRAC	1991	S			
267	556	C	2	235	82	586	0	1535	SE		SORRENCA BNA		0	0	0	FRAG	1991	S			
267	556	C	2	236	233	735	0	1508	P		CALCARIA BNA		0	0	0	FRAG ALTERAT	1991	S			
267	556	C	2	237	307	722	0	1505	SW		SORRENCA BNA		0	0	0	FRAG	1991	S			
267	556	C	2	238	22	822	0	1505	NE		RMI BNA		0	0	0	FRAG	1991	S			
267	556	C	2	239	408	604	0	1505	S		SORRENCA BNA		0	0	0	FRAG ALTERAT	1991	S			
267	556	C	2	240	507	223	0	1572	S		QUARS BNA		0	0	0	FRAG	1991	S			
267	556	C	2	241	529	307	0	1565	S		QUARSITA BNA		0	0	0		1991	S			
267	556	C	2	242	534	400	0	1534	S		SORRENCA BNA		0	0	0	FRAG	1991	S			
267	556	C	2	243	482	432	0	1543	N		CALCARIA BNA		0	0	0	FRAG	1991	S			
267	556	C	2	244	413	409	0	1551	SE		SORRENCA BNA		0	0	0	FRAG	1991	S			
267	556	C	2	245	153	392	0	1555	E		SORRENCA BNA		0	0	0	FRAG	1991	S			
267	556	C	2	246	287	545	1489	1545	W		SORRENCA BNA		0	0	0	FRAG	1991	S			
267	556	C	2	247	289	632	0	1520	S		SORRENCA BNA		0	0	0	FRAG	1991	S			
267	556	C	2	248	139	654	0	1532	SW		RMI BNA		0	0	0	FRAG	1991	S			
267	556	C	2	249	606	876	0	1522	E		QUARS BNA		0	0	0	FRAG	1991	S			
267	556	C	2	250	876	750	0	1510	P		CERAMICA INFORME		0	0	0		1991	S			
267	556	C	2	251	906	952	0	1486	SW		SORRENCA BNA		0	0	0	FRAG	1991	S			
267	556	C	2	252	900	798	0	1515	N		CERAMICA INFORME		0	0	0		1991	S			
267	556	C	2	253	673	895	0	1520	P		CERAMICA APLICA		0	0	0	LLENGUETA	1991	S			
267	556	C	2	254	442	856	0	1514	W		CERAMICA NANSA		0	0	0		1991	S			
267	556	C	2	255	192	645	0	1554	SW		CALCARIA BNA		0	0	0	FRAG ALTERAT	1991	S			
267	556	C	2	256	655	505	0	1568	SE		RMI BNA		0	0	0	FRAG	1991	S			
267	556	C	2	257	182	573	0	1585	W		RMI BNA		0	0	0	FRAG	1991	S			

147

BOBILA MADURELL  
MAS DURAN  
Objectes Coordenats C5  
Campanya 1991

c	c	C	N	NUM.	X	Y	Zsup	Zinf	ORIENT	PENDENT	MATERIA	OBJECTE	LONG	AMPL	ESPE	ALTERACIONS	OBSERVACIONS	P	D
uX	uY	O	I															ANY	U
a	a	N	V															N	B
d	d	J																T	U
267	556	C	2	258	137	549	0	1575	E		RMI	BNA	0	0	0	FRAG		1991	S
267	556	C	3	259	704	135	0	1555	S		SORRENCA	BNA	0	0	0	FRAG		1991	S
267	556	C	3	260	651	180	0	1555	P		QUARS	BNA	0	0	0	FRAG		1991	S
267	556	C	3	261	641	96	0	1554	SW		CALCARIA	BNA	0	0	0	FRAG		1991	S
267	556	C	3	262	972	110	0	1550	W		QUARS	BNA	0	0	0	FRAG		1991	S
267	556	C	3	263	843	148	0	1544	NW		CERAMICA	INFORME	0	0	0			1991	S
267	556	C	3	264	415	68	0	1595	W		CERAMICA	INFORME	0	0	0			1991	S
267	556	C	3	265	267	15	0	1640	V		QUARS	BNA	0	0	0	FRAG		1991	S
267	556	C	3	266	363	308	0	1620	N		CERAMICA	INFORME	0	0	0			1991	S
267	556	C	3	267	120	549	0	1636	V		QUARS	BNA	0	0	0	FRAG		1991	S
267	556	C	3	268	172	851	0	1615			OS	INDET	0	0	0			1991	S
267	556	C	3	269	258	891	0	1630	S		SILEX	BN2G	0	0	0			1991	S
267	556	C	3	270	446	926	0	1600	SW		RMI	BNA	0	0	0	FRAG		1991	S
267	556	C	3	271	119	445	0	1654	E		CERAMICA	PANXA	0	0	0			1991	S
267	556	C	3	272	505	641	0	1695	SW		QUARS	BPI	0	0	0			1991	S
267	556	C	3	273	157	960	0	1692			SORRENCA	BNA	0	0	0	FRAG		1991	S
267	556	C	3	274	856	851	0	1700	SE		QUARS	BNA	0	0	0			1991	S
267	556	C	3	275	189	815	0	1749			OS	DET	0	0	0	MD		1991	S
267	556	C	3	276	109	152	0	1764	SE		CERAMICA	INFORME	0	0	0	FRAG		1991	S
267	556	C	3	277	550	261	0	1745			ORGANIC	CARBO	0	0	0			1991	S
267	556	C	3	278	132	683	0	1763			CALCARIA	BNA	0	0	0	ALTERAT		1991	S
267	556	C	3	279	273	637	0	1770			CALCARIA	BNA	0	0	0			1991	S
267	556	C	3	280	600	241	0	1788			ORGANIC	CARBO	0	0	0			1991	S
267	556	C	3	281	899	420	0	0	N		RMI	BNA	0	0	0	FRAG		1991	S
267	556	C	3	282	805	351	0	1778	W		CERAMICA	INFORME	0	0	0			1991	S
267	556	C	3	283	725	312	0	1787	SE		CERAMICA	VORA	0	0	0	2 LLENGUETES		1991	S
267	556	C	3	284	647	163	0	1779	SW		CERAMICA	INFORME	0	0	0			1991	S
267	556	C	3	285	683	40	0	1817	SW		CERAMICA	INFORME	0	0	0			1991	S
267	556	C	3	286	559	34	0	1849	SE		CERAMICA	INFORME	0	0	0			1991	S
267	556	C	3	287	450	29	0	1851	S		CERAMICA	VORA	0	0	0			1991	S
267	556	C	3	288	187	24	0	1845	P		RMI	BPI	0	0	0			1991	S
267	556	C	3	289	752	46	0	1814	SW		RMI	BPI	0	0	0	FRAG		1991	S
267	556	C	3	290	610	945	0	1807	NW		RMI	BPF	0	0	0			1991	S
267	556	C	3	291	863	641	0	1800	SW		SORRENCA	BNA	0	0	0			1991	S
267	556	C	3	292	806	511	0	1814	P		CALCARIA	BN1G	0	0	0			1991	S
267	556	C	3	293	149	208	0	1926	SE		CALCARIA	BNA	0	0	0	FRAG ALTERAT		1991	S
267	556	C	3	294	65	132	0	1940	SW		RMI	BNA	0	0	0	FRAG ALTERAT		1991	S
267	556	C	3	295	156	39	0	1943	N		CALCARIA	BNA	0	0	0	FRAC ALTERAT		1991	S
267	556	C	3	296	54	21	0	1960	SW		RMI	BNA	0	0	0	FRAG ALTERAT		1991	S
267	556	C	3	297	154	6	0	1930	W		CALCARIA	BNA	0	0	0	FRAG ALTERAT		1991	S
267	556	C	3	298	627	40	0	1910	SE		RMI	BNA	0	0	0	FRAG ALTERAT		1991	S
267	556	C	3	299	555	197	0	1880	V		RMI	BNA	0	0	0	FRAG ALTERAT		1991	S
267	556	C	3	300	466	277	0	1881	S		CALCARIA	BNA	0	0	0	FRAG ALTERAT		1991	S
267	556	C	3	301	365	96	0	1899	S		RMI	BNA	0	0	0	FRAG ALTERAT		1991	S
267	556	C	3	302	275	148	0	1885	S		CALCARIA	BNA	0	0	0	FRAG ALTERAT		1991	S
267	556	C	3	303	273	68	0	1915	SE		SORRENCA	BNA	0	0	0	FRAG		1991	S
267	556	C	3	304	199	139	0	1925	N		RMI	BNA	0	0	0	FRAG ALTERAT		1991	S
267	556	C	3	305	274	276	0	1952	S		CALCARIA	BNA	0	0	0	ALTERAT		1991	S
267	556	C	3	306	275	12	0	1959	SE		SORRENCA	BNA	0	0	0	FRAG ALTERAT		1991	S
267	556	C	3	307	317	21	0	1944	W		RMI	BNA	0	0	0	FRAG ALTERAT		1991	S

BOBILA MADURELL  
MAS DURAN  
Objectes Coordinats C5  
Campanya 1991

c	c	C	N											ALTERACIONS	P	D			
uX	uY	O	I	NUM.	X	Y	Zsup	Zinf	ORIENT	PENDENT	MATERIA	OBJECTE	LONG	AMPL	ESPE	OBSERVACIONS	ANY	U	I
a	a	N	V															N	B
d	d	J																T	U
267	556	c	3	308	377	10	0	1917	SW		SORRENCA	BNA	0	0	0	ALTERAT	1991	S	
267	556	c	3	309	476	16	0	1944	SE		RMI	BNA	0	0	0	FRAG ALTERAT	1991	S	
267	556	c	3	310	612	103	0	1905	S		RMI	BNA	0	0	0	FRAG ALTERAT	1991	S	
267	556	c	3	311	431	110	0	1915	SE		RMI	BNA	0	0	0	FRAG ALTERAT	1991	S	
267	556	c	3	312	328	225	0	1917	S		RMI	BNA	0	0	0	ALTERAT	1991	S	
267	556	c	3	313	284	161	0	1995	P		TOVOT	FRAG	0	0	0		1991	S	
267	556	c	3	314	850	800	0	1812	P		QUARS	BNA	0	0	0		1991	S	
267	556	c	3	315	558	936	0	1813	SW		RMI	BNA	0	0	0	FRAG	1991	S	
267	556	c	3	316	513	496	0	1847	E		CALCARIA	BNA	0	0	0		1991	S	
267	556	c	3	317	864	821	0	1849	N		QUARS	BNA	0	0	0		1991	S	
267	556	c	3	318	497	820	0	1146	E		SORRENCA	BNA	0	0	0	FRAG	1991	S	
267	557	c		1	419	56	1220	1295	E-W	W	SORRENCA	BNA	0	0	0	FRAG ALTERAT	1991	S	
267	557	c		2	525	156	0	1296	NW		QUARS	BNA	0	0	0	FRAG	1991	S	
267	557	c		3	145	326	0	1273	NW		CERAMICA	APLICA	0	0	0	MJGRO	1991	S	
267	557	c		4	451	356	0	1318	SW		RMI	BNA	0	0	0	FRAG	1991	S	
267	557	c		5	433	687	0	1225	SE		SORRENCA	BNA	0	0	0	FRAG	1991	S	
267	557	c		6	502	657	0	1241	W		CERAMICA	INFORME	0	0	0		1991	S	
267	557	c		7	839	723	0	1262	N		QUARS	BNA	0	0	0	FRAG	1991	S	
267	557	c		8	896	767	1223	1243	W		CERAMICA	INFORME	0	0	0		1991	S	
267	557	c	2	9	105	872	0	1310	NE-SW	P	INDET	BNA	0	0	0	FRAG	1991	S	
267	557	c	2	10	81	664	0	1304	E-W	V	RMI	BNA	0	0	0	FRAG	1991	S	
267	557	c	2	11	263	691	0	1306	NW-SE	S	QUARS	BNA	0	0	0	FRAG	1991	S	
267	557	c	2	12	793	898	0	1320	NW-SE	S	QUARS	BNA	0	0	0	FRAG	1991	S	
267	557	c	2	13	868	567	0	1312	N-S	P	QUARSITA	BNA	0	0	0	FRAG	1991	S	
267	557	c	2	14	640	918	0	1319		P	QUARS	BNA	0	0	0	FRAG	1991	S	
267	557	c	2	15	697	261	0	1319			CERAMICA	INFORME	0	0	0		1991	S	
267	557	c	2	16	649	48	0	1335			CERAMICA	INFORME	0	0	0		1991	S	
267	557	c	2	17	890	64	0	1314			CERAMICA	INFORME	0	0	0		1991	S	
267	557	c	2	18	434	38	0	1342			OS	INDET	0	0	0		1991	S	
267	557	c	2	19	492	188	0	1341	SW		QUARS	BNA	0	0	0	FRAG	1991	S	
267	557	c	2	20	530	375	0	1323	SW		CERAMICA	APLICA	0	0	0	MJGRO	1991	S	
267	557	c	2	21	805	905	0	1275	N		QUARS	BNA	0	0	0	FRAG	1991	S	
267	557	c	2	22	655	891	0	1281	P		SORRENCA	BNA	0	0	0	FRAG	1991	S	
267	557	c	2	23	805	906	0	1330	E		RMI	BNA	0	0	0	FRAG	1991	S	
267	557	c	2	24	402	297	0	1360	P		CONGLOME	BNA	0	0	0		1991	S	
267	557	c	2	25	607	315	0	1354	S		SORRENCA	BNA	0	0	0	FRAG	1991	S	
267	557	c	2	26	16	33	0	1340	P		QUARSITA	BNA	0	0	0	FRAC	1991	S	
267	557	c	2	27	450	984	0	1320	NE		QUARS	BNA	0	0	0	FRAG	1991	S	
267	557	c	2	28	68	22	0	1420	S		QUARSITA	BPF	0	0	0		1991	S	
267	557	c	2	29	339	90	0	1365	NW		QUARS	BNA	0	0	0	FRAG	1991	S	
267	557	c	2	30	373	109	0	1354	NE		CONGLOME	BNA	0	0	0	FRAG MICROCONGL	1991	S	
267	557	c	2	31	278	269	1336	1361	NW		RMI	BNA	0	0	0	FRAG	1991	S	
267	557	c	2	32	159	488	0	1374	NE		RMI	BNA	0	0	0	FRAG	1991	S	
267	557	c	2	33	303	581	1337	1390	E		RMI	BNA	0	0	0	FRAG	1991	S	
267	557	c	2	34	380	694	1326	1351	S		ESQUIST	BNA	0	0	0	FRAG	1991	S	
267	557	c	2	35	313	785	1301	1340	N		QUARS	BNA	0	0	0	FRAC	1991	S	
267	557	c	2	36	317	823	0	1343	NW		RMI	BNA	0	0	0	FRAG	1991	S	
267	557	c	2	37	380	911	1300	1339	N		RMI	BNA	0	0	0	FRAG	1991	S	
267	557	c	2	38	359	964	0	1336	SE		QUARS	BNA	0	0	0	FRAG	1991	S	
267	557	c	2	39	950	504	0	1359	E		CERAMICA	INFORME	0	0	0		1991	S	

149



BOBILA MADURELL  
MAS DURAN  
Objectes Coordenats C5  
Campanya 1991

c	c	C	N											ALTERACIONS	P	D			
uX	uY	O	I	NUM.	X	Y	Zsup	Zinf	ORIENT	PENDENT	MATERIA	OBJECTE	LONG	AMPL	ESPE	OBSERVACIONS	ANY	U	I
a	a	N	V															N	B
d	d	J																T	U
267	557	C	2	40	938	528	0	1354	E		QUARS	BPI	0	0	0		1991	S	
267	557	C	2	41	924	857	0	1316	SE		CALCARIA	BNA	0	0	0	NO RECUPERAT	1991	S	
267	557	C	2	42	752	981	0	1330	SE		CALCARIA	BNA	0	0	0	FRAG NO RECUPER	1991	S	
267	557	C	2	43	814	971	0	1327	NW		QUARS	BPI	0	0	0		1991	S	
267	557	C	2	44	985	534	0	1353	NE		QUARS	BNA	0	0	0	FRAG	1991	S	
267	557	C	2	45	27	38	0	1398	W		QUARSITA	BNA	0	0	0	FRAG	1991	S	
267	557	C	2	46	163	41	0	1415	P		SORRENCA	BNA	0	0	0		1991	S	
267	557	C	2	47	118	110	0	1385	P		SORRENCA	BNA	0	0	0		1991	S	
267	557	C	2	48	73	13	0	1395	SW		CALCARIA	BNA	0	0	0		1991	S	
267	557	C	2	49	263	38	0	1398	W		QUARS	BNA	0	0	0	FRAG	1991	S	
267	557	C	2	50	368	41	0	1380			RMI	BNA	0	0	0	FRAG	1991	S	
267	557	C	2	51	377	78	0	1382	NE		RMI	BNA	0	0	0		1991	S	
267	557	C	2	52	179	436	0	1394	S		RMI	BNA	0	0	0	FRAG	1991	S	
267	557	C	2	53	149	223	0	1394	V		SORRENCA	BNA	0	0	0		1991	S	
267	557	C	2	54	228	250	0	1398	SE		SORRENCA	BNA	0	0	0		1991	S	
267	557	C	2	55	303	249	0	1390	SW		SORRENCA	BNA	0	0	0	FRAG	1991	S	
267	557	C	2	56	105	258	0	1400	NE		CERAMICA	INFORME	0	0	0		1991	S	
267	557	C	2	57	159	309	0	1385	SW		SILEX	BPF	0	0	0		1991	S	
267	557	C	2	58	420	293	0	1406	N		RMI	BNA	0	0	0	FRAG	1991	S	
267	557	C	2	59	497	278	0	1409			CERAMICA	INFORME	0	0	0		1991	S	
267	557	C	2	60	473	374	0	1396	P		SORRENCA	BNA	0	0	0	FRAG	1991	S	
267	557	C	2	61	823	500	1298	1414	SE		SORRENCA	BNA	0	0	0	FRAG	1991	S	
267	557	C	2	62	963	721	0	1375	P		QUARS	BNA	0	0	0		1991	S	
267	557	C	2	63	936	537	0	1368			QUARS	BPI	0	0	0		1991	S	
267	557	C	2	64	940	571	0	1371	W		QUARS	BNA	0	0	0	FRAG	1991	S	
267	557	C	2	65	982	602	0	1356	P		QUARS	BNA	0	0	0	FRAG	1991	S	
267	557	C	2	66	124	178	0	1402	V		SORRENCA	BNA	0	0	0	NO RECUPERAT	1991	S	
267	557	C	2	67	67	215	0	1413	S		SORRENCA	BNA	0	0	0	FRAG	1991	S	
267	557	C	2	68	851	780	0	1385	P		SORRENCA	BNA	0	0	0	FRAG	1991	S	
267	557	C	2	69	929	835	0	1384	W		RMI	BNA	0	0	0	FRAG	1991	S	
267	557	C	2	70	968	932	0	1374	W		RMI	BNA	0	0	0	FRAG	1991	S	
267	557	C	2	71	816	912	0	1386	NW		QUARS	BNA	0	0	0	FRAG	1991	S	
267	557	C	2	72	650	828	0	1406			CALCARIA	BNA	0	0	0		1991	S	
267	557	C	2	73	482	864	0	1400	S		CALCARIA	BNA	0	0	0	FRAG	1991	S	
267	557	C	2	74	452	978	0	1356	W		CERAMICA	INFORME	0	0	0		1991	S	
267	557	C	2	75	18	276	0	1413	P		QUARS	BNA	0	0	0		1991	S	
267	557	C	2	76	169	77	0	1423	E		CONGLOME	BNA	0	0	0	FRAG MICROCONGL	1991	S	
267	557	C	2	77	462	572	0	1455	NE		RMI	BNA	0	0	0	FRAG	1991	S	
267	557	C	2	78	567	612	0	1446	NE		INDET	BNA	0	0	0	FRAG	1991	S	
267	557	C	2	79	594	764	0	1434	W		SORRENCA	BNA	0	0	0	FRAG	1991	S	
267	557	C	2	80	697	801	0	1427	P		SORRENCA	BNA	0	0	0	FRAG	1991	S	
267	557	C	2	81	814	831	0	1412	N		SORRENCA	BNA	0	0	0	FRAG	1991	S	
267	557	C	2	82	564	951	0	1430	W		SORRENCA	BNA	0	0	0		1991	S	
267	557	C	2	83	637	973	0	1425	W		QUARS	BNA	0	0	0	FRAG	1991	S	
267	557	C	2	84	719	926	0	1427	P		ESQUIST	BNA	0	0	0	FRAG	1991	S	
267	557	C	2	85	853	959	0	1423	N		QUARS	BNA	0	0	0	FRAG	1991	S	
267	557	C	2	86	950	966	0	1394	S		CALCARIA	BNA	0	0	0	FRAG	1991	S	
267	557	C	2	87	53	278	0	1420	S		QUARS	BNA	0	0	0	FRAG	1991	S	
267	557	C	2	88	535	666	0	1447	SE		RMI	BNA	0	0	0	FRAG	1991	S	
267	557	C	2	89	780	882	0	1411	P		RMI	BNA	0	0	0	FRAG	1991	S	

BOBILA MADURELL  
MAS DURAN  
Objectes Coordinats C5  
Campanya 1991

c	c	C	M									ALTERACIONS			P	D					
uX	uY	O	I	NUM.	X	Y	Zsup	Zinf	ORIENT	PENDENT	MATERIA	OBJECTE	LONG	AMPL	ESPE	OBSERVACIONS	ANY	U	I		
a	a	N	V																N	B	
d	d	J																		T	U
267	557	C	2	90	533	742	0	1460			TOVOT	FRAG	0	0	0		1991	S			
267	557	C	2	91	463	656	0	1455	V		CERAMICA	INFORME	0	0	0		1991	S			
267	557	C	2	92	489	760	0	1446	E		CONGLOME	BNA	0	0	0	MICROCONGLOME	1991	S			
267	557	C	2	93	434	887	0	1443			OS	INDET	0	0	0		1991	S			
267	557	C	2	94	512	859	0	1438	P		SORRENCA	BNA	0	0	0	FRAG	1991				
267	557	C	2	95	614	847	0	1440	W		CERAMICA	APLICA	0	0	0	LLENGETA RODAT	1991	S			
267	557	C	2	96	673	734	0	1445	E		INDET	BNA	0	0	0	FRAG	1991	S			
267	557	C	2	97	834	623	1350	1477	V		SORRENCA	BNA	0	0	0	FRAG ALTERAT	1991	S			
267	557	C	2	98	542	776	0	1445	W		CERAMICA	INFORME	0	0	0		1991	S			
267	557	C	2	99	556	774	0	1443	W		CERAMICA	INFORME	0	0	0		1991	S			
267	557	C	2	100	574	775	0	1445	W		CERAMICA	INFORME	0	0	0		1991	S			
267	557	C	2	101	562	794	0	1445	W		CERAMICA	INFORME	0	0	0		1991	S			
267	557	C	2	102	290	348	0	1455	V		CERAMICA	INFORME	0	0	0		1991	S			
267	557	C	2	103	240	41	0	1453	P		CALCARIA	BNA	0	0	0	FRAG ALTERAT	1991	S			
267	557	C	2	104	196	198	0	1431	P		CONGLOME	BNA	0	0	0	FRAG MICROCONGL	1991	S			
267	557	C	2	105	156	128	0	1425	SW		RMI	BNA	0	0	0	FRAG	1991	S			
267	557	C	2	106	477	900	0	1450	W		SORRENCA	BNA	0	0	0	FRAG	1991	S			
267	557	C	2	107	465	490	0	1482	N		OS	DET	0	0	0		1991	S			
267	557	C	2	108	305	845	0	1502	W		SORRENCA	BNA	0	0	0	FRAG	1991	S			
267	557	C	2	109	275	792	0	1498	V		INDET	BNA	0	0	0	FRAC	1991	S			
267	557	C	2	110	308	688	0	1487	NE		SORRENCA	BNA	0	0	0	FRAG	1991	S			
267	557	C	2	111	390	703	0	1500	V		SORRENCA	BNA	0	0	0	ALTERAT FRAG	1991	S			
267	557	C	2	112	31	704	0	1508	E		SORRENCA	BNA	0	0	0	FRAG	1991	S			
267	557	C	2	113	196	608	0	1480	W		SORRENCA	BNA	0	0	0	NO RECUPERAT	1991	S			
267	557	C	2	114	100	509	0	1485	E		CALCARIA	BNA	0	0	0	FRAG	1991	S			
267	557	C	2	115	221	410	0	1498	N		SORRENCA	BNA	0	0	0	FRAG NO RECUPER	1991	S			
267	557	C	2	116	455	433	0	1517	S		CERAMICA	INFORME	0	0	0		1991	S			
267	557	C	2	117	511	138	0	1513	SW		SORRENCA	BNA	0	0	0	FRAG	1991	S			
267	557	C	2	118	252	147	0	1520	V		CERAMICA	INFORME	0	0	0		1991	S			
267	557	C	2	119	511	138	0	1503	S		QUARS	BNA	0	0	0	NO RECUPERAT	1991	S			
267	557	C	2	120	252	147	0	1514			CERAMICA	INFORME	0	0	0	NO RECUPERAT	1991	S			
267	557	C	2	121	207	264	0	1509			CERAMICA	INFORME	0	0	0	NO RECUPERAT	1991	S			
267	557	C	2	122	381	413	0	1509	W		QUARS	BNA	0	0	0	FRAG	1991	S			
267	557	C	2	123	521	608	0	1516	S		CERAMICA	VORA	0	0	0		1991	S			
267	557	C	2	124	134	721	0	1506	W		CERAMICA	INFORME	0	0	0		1991	S			
267	557	C	2	125	696	717	0	1514	V		CERAMICA	VORA	0	0	0		1991	S			
267	557	C	2	126	661	864	0	1520	P		CERAMICA	INFORME	0	0	0	NO RECUPERAT	1991	S			
267	557	C	2	127	536	832	0	1525	P		RMI	BNA	0	0	0	FRAG	1991	S			
267	557	C	2	128	198	298	0	1520	N		CERAMICA	INFORME	0	0	0		1991	S			
267	557	C	2	129	403	746	0	1525	N		SILEX	BN2G	0	0	0		1991	S			
267	557	C	2	130	353	869	0	1510	P		OS	DET	0	0	0	MD	1991	S			
267	557	C	2	131	471	956	0	1520	W		CERAMICA	VORA	0	0	0		1991	S			
267	557	C	2	132	661	995	0	1525			OS	INDET	0	0	0	NO RECUPERAT	1991	S			
267	557	C	2	133	659	950	0	1530	N		CERAMICA	INFORME	0	0	0		1991	S			
267	557	C	2	134	460	971	0	1563	P		CERAMICA	VORA	0	0	0		1991	S			
267	557	C	2	135	426	952	0	1956	P		OS	INDET	0	0	0	VARIS FRAGS	1991	S			
267	557	C	2	137	235	668	0	1577	E		CERAMICA	CARENA	0	0	0		1991	S			
267	557	C	2	138	231	547	0	1498	SW		SORRENCA	BPF	0	0	0		1991	S			
267	557	C	2	139	234	169	0	1620	S		OS	DET	0	0	0	FRAGS CRA	1991	S			
267	557	C	2	140	63	656	0	1544	NE		SORRENCA	BNA	0	0	0	FRAG	1991	S			

BOBILA MADURELL  
MAS DURAN  
Objectes Coordenats C5  
Campanya 1991

c	c	C	N	NUM.	X	Y	Zsup	Zinf	ORIENT	PENDENT	MATERIA	OBJECTE	LONG	AMPL	ESPE	ALTERACIONS	OBSERVACIONS	P	D
uX	uY	O	I															ANY	U
a	a	N	V															N	B
d	d	J																T	U
267	557	C	2	141	34	852	0	1615	P	OS	INDET		0	0	0			1991	S
267	557	C	3	142	116	609	0	1634	N	SORRENCA	BNA		0	0	0	FRAG		1991	S
267	557	C	3	143	241	403	0	1634	S	CALCARIA	BNA		0	0	0			1991	S
267	557	C	3	144	362	91	0	1636	SW	OS	DET		0	0	0	CST		1991	S
267	557	C	3	145	433	329	0	1637	SE	OS	DET		0	0	0	FRAG PEL		1991	S
267	557	C	3	146	254	449	0	1662	N	OS	DET		0	0	0	FRAG VT		1991	S
267	557	C	3	147	424	330	0	1663	V	OS	DET		0	0	0	VT		1991	S
267	557	C	3	148	395	532	0	1665	S	QUARS	BNA		0	0	0			1991	S
267	557	C	2	149	822	76	0	1513	S	SORRENCA	BNA		0	0	0	FRAG		1991	
267	557	C	2	150	887	57	0	1513	SW	RMI	BNA		0	0	0	FRAG		1991	
267	557	C	2	151	824	152	0	1523	W	CALCARIA	BNA		0	0	0	FRAC		1991	S
267	557	C	2	152	974	810	0	1450	P	CERAMICA	INFORME		0	0	0			1991	
267	557	C	2	153	947	670	0	1525	P	CERAMICA	VORA		0	0	0			1991	S
267	557	C	2	154	923	439	0	1550	W	RMI	BNA		0	0	0			1991	S
267	557	C	2	155	542	11	1523	1593	SW	SORRENCA	BNA		0	0	0	ALTERAT		1991	S
267	557	C	2	156	872	258	0	1573	P	OS	INDET		0	0	0			1991	S
267	557	C	2	157	894	56	0	1592	W	ESQUIST	BNA		0	0	0	FRAG		1991	S
267	557	C	2	158	868	3	0	1582	NW	ESQUIST	BNA		0	0	0	FRAG		1991	S
267	557	C	3	159	918	952	0	1566	P	RMI	BNA		0	0	0	FRAG		1991	S
267	557	C	3	160	604	161	0	1620	P	CERAMICA	APLICA		0	0	0	MAMELLO		1991	S
267	557	C	3	161	584	421	0	1664	P	SORRENCA	BNA		0	0	0	FRAG		1991	S
267	557	C	3	162	357	637	0	1654	P	OS	INDET		0	0	0			1991	S
267	557	C	3	163	279	824	0	1697	P	CONGLOME	BNA		0	0	0			1991	S
267	557	C	3	164	614	833	0	1674	P	OS	DET		0	0	0	TI		1991	S
267	557	C	3	165	501	835	0	1680	P	OS	DET		0	0	0	PR		1991	S
267	557	C	3	166	206	932	0	1698	P	OS	DET		0	0	0	MD Inf		1991	S
267	557	C	3	167	420	137	0	1675	NW	OS	INDET		0	0	0			1991	S
267	557	C	3	168	379	344	0	1681	P	OS	INDET		0	0	0			1991	S
267	557	C	3	169	909	113	0	1670	P	CALCARIA	BNA		0	0	0	FRAG ALTERAT		1991	S
267	557	C	3	170	425	595	0	1710		OS	INDET		0	0	0	FRAG		1991	S
267	557	C	3	171	93	721	0	1716		OS	INDET		0	0	0	FRAG		1991	S
267	557	C	3	172	182	861	0	1712		OS	DET		0	0	0	FRAG		1991	S
267	557	C	3	173	445	950	0	1697	S	OS	INDET		0	0	0	FRAG		1991	S
267	557	C	3	174	650	900	0	1695		CERAMICA	INFORME		0	0	0			1991	S
267	557	C	3	175	608	989	0	1692	N	CALCARIA	BP		0	0	0			1991	S
267	557	C	3	176	264	142	0	1747	N	CERAMICA	INFORME		0	0	0			1991	S
267	557	C	3	177	241	106	0	1766		OS	DET		0	0	0	FRAG		1991	S
267	557	C	3	178	450	951	0	1737	NE	CERAMICA	INFORME		0	0	0			1991	S
267	557	C	3	179	129	654	0	1758		CERAMICA	INFORME		0	0	0			1991	S
267	557	C	3	180	870	937	0	1729		SORRENCA	BNA		0	0	0	FRAG ALTERAT		1991	S
267	557	C	3	181	985	645	0	1709		QUARS	BNA		0	0	0	FRAG		1991	S
267	557	C	3	182	213	387	0	1748	N	CERAMICA	INFORME		0	0	0			1991	S
267	557	C	3	183	129	658	0	1766	E	CERAMICA	INFORME		0	0	0	2 FRAGS		1991	S
267	557	C	3	184	852	409	0	1754	W	QUARSITA	BPF		0	0	0			1991	S
267	557	C	3	185	913	718	0	1757	W	CERAMICA	INFORME		0	0	0			1991	S
267	557	C	3	186	841	633	0	1749	P	RMI	BNA		0	0	0	FRAG		1991	S
267	557	C	3	187	416	562	0	1791	E	RMI	BNA		0	0	0	FRAG		1991	S
267	557	C	3	188	19	888	0	1820	SE	QUARS	BNA		0	0	0	FRAG		1991	S
267	557	C	3	189	116	873	0	1812	P	QUARS	BNA		0	0	0	FRAC		1991	S
267	557	C	3	190	14	736	0	1831	S	CERAMICA	PANXA		0	0	0	5 FRAGS		1991	S

BOBILA MADURELL  
 MAS DURAN  
 Objectes Coordenats C5  
 Campanya 1991

c	c	C	N	NUM.	X	Y	Zsup	Zinf	ORIENT	PENDENT	MATERIA	OBJECTE	LONG	AMPL	ESPE	OBSERVACIONS	ALTERACIONS	P	D
uX	uY	O	I																
a	a	N	V																
d	d	J																	
																		ANY	U
																			I
																			N
																			B
																			T
																			U
267	557	C	3	191	121	746	0	1835	V		QUARS	BNA	0	0	0			1991	S
267	557	C	3	192	267	748	0	1799	P		RMI	BNA	0	0	0	FRAG		1991	S
267	557	C	3	193	233	678	0	1819	P		QUARS	BNA	0	0	0	FRAG		1991	S
267	557	C	3	194	420	310	0	1805	V		QUARS	BN1G	0	0	0			1991	S
267	557	C	3	195	336	127	0	1804	P		CALCARIA	BNA	0	0	0			1991	S
267	557	C	3	196	709	709	0	1821	E		QUARS	BPF	0	0	0			1991	S
267	557	C	3	197	691	540	0	1821	W		OS	DET	0	0	0			1991	S
267	557	C	3	198	555	83	0	1842	W		QUARS	BNA	0	0	0	FRAG		1991	S
267	557	C	3	199	441	253	0	1844	S		RMI	BPF	0	0	0			1991	S
267	557	C	3	200	419	646	0	1842	N		RMI	BNA	0	0	0	FRAG		1991	S
267	557	C	3	201	377	734	0	1837	E		RMI	BNA	0	0	0	FRAG		1991	S
267	557	C	3	202	167	595	0	1851	E		OS	DET	0	0	0			1991	S
267	557	C	3	203	139	239	0	1837	E		QUARS	BP	0	0	0			1991	S
267	557	C	3	204	49	703	0	1849			CALCARIA	BPF	0	0	0			1991	S
267	557	C	3	205	59	455	0	1835			SORRENCA	BNA	0	0	0	FRAG		1991	S
267	557	C	3	206	581	522	0	1846			RMI	BNA	0	0	0	FRAG		1991	S
267	557	C	3	207	164	476	0	1864			CERAMICA	INFORME	0	0	0	FRAG		1991	S
267	557	C	3	208	71	326	0	1864			CERAMICA	INFORME	0	0	0			1991	S
267	557	C	3	209	260	20	0	1836			CERAMICA	VORA	0	0	0			1991	S
267	557	C	3	210	926	520	0	1860	P		QUARS	BNA	0	0	0	FRAC		1991	S
267	557	C	3	211	857	631	0	1869	P		QUARS	BNA	0	0	0	FRAG		1991	S
267	557	C	3	212	301	147	0	1905	S		RMI	BNA	0	0	0	FRAG		1991	S
267	557	C	3	213	309	42	0	1924	V		RMI	BNA	0	0	0	FRAG		1991	S
267	557	C	2	214	79	925	1412	1434	E-W	P	RMI	BNA	0	0	0	FRAG		1991	S
267	557	C	2	215	87	758	1411	1450	NE-SW	SW	CALCARIA	BNA	0	0	0	FRAG		1991	S
267	557	C	2	216	263	792	1414	1429	N-S	S	RMI	BNA	0	0	0	FRAG		1991	S
267	557	C	2	217	45	402	0	1455	N-S	P	CALCARIA	FRAG	0	0	0			1991	S
267	557	C	2	218	739	965	1438	1455	E-W	W	CERAMICA	INFORME	0	0	0	2 FRAGS		1991	S
267	557	C	2	219	639	911	0	1430	P		CERAMICA	INFORME	0	0	0			1991	S
267	557	C	2	220	692	708	0	1424	N-S	SW	SORRENCA	FRAG	0	0	0			1991	S
267	557	C	2	221	444	909	0	1462	N-S	P	SORRENCA	BNA	0	0	0	FRAG		1991	S
267	558	C		1	20	802	0	1219	V		SORRENCA	BNA	0	0	0	FRAG NO RECUPER		1991	S
267	558	C		2	365	576	0	1196	W		QUARSITA	BNA	0	0	0	FRAG		1991	S
267	558	C		3	339	508	0	1204	P		SORRENCA	BNA	0	0	0	FRAG		1991	S
267	558	C		4	312	406	0	1216	V		SORRENCA	BNA	0	0	0	FRAG		1991	S
267	558	C		5	783	450	0	1187	V		CERAMICA	INFORME	0	0	0			1991	S
267	558	C		6	720	395	0	1205	S		SORRENCA	BNA	0	0	0	FRAG		1991	S
267	558	C		7	810	229	0	1189	S		QUARS	BNA	0	0	0	FRAG		1991	S
267	558	C	2	8	295	451	0	1233	V		QUARS	BNA	0	0	0			1991	S
267	558	C	2	9	472	593	0	1234	P		RMI	BNA	0	0	0	FRAG		1991	S
267	558	C	2	10	842	366	0	1220	P		QUARS	BNA	0	0	0	FRAG		1991	S
267	558	C	2	11	817	139	0	1224	P		SORRENCA	BNA	0	0	0			1991	S
267	558	C	2	12	860	159	0	1222	W		RMI	BNA	0	0	0	FRAG		1991	S
267	558	C	2	13	343	346	0	1246	SW		ESQUIST	BNA	0	0	0	FRAG		1991	S
267	558	C	2	14	423	339	0	1246	N		SORRENCA	BNA	0	0	0	FRAG		1991	S
267	558	C	2	15	947	514	0	1239	SE		QUARS	BNA	0	0	0	FRAG		1991	S
267	558	C	2	16	923	228	0	1218	S		RMI	BNA	0	0	0			1991	S
267	558	C	2	17	982	34	0	1232	NE		RMI	BNA	0	0	0	FRAG		1991	S
267	558	C	2	18	469	322	0	1251	P		CERAMICA	VORA	0	0	0			1991	S
267	558	C	2	19	598	48	0	1260	P		ESQUIST	BNA	0	0	0	FRAG		1991	S

BOBILA MADURELL  
MAS DURAN  
Objectes Coordenats C5  
Campanya 1991

c	c	C	N	NUM.	X	Y	Zsup	Zinf	ORIENT	PENDENT	MATERIA	OBJECTE	LONG	AMPL	ESPE	ALTERACIONS OBSERVACIONS	P D	ANY	U I	N B	T U
uX	uY	O	I																		
a	a	N	V																		
d	d	J																			
267	558	C	2	20	905	339	0	1250	NW		QUARS	BPI	0	0	0			1991	S		
267	558	C	2	21	46	63	0	1308	V		INDET	BNA	0	0	0	NO RECUPERAT		1991	S		
267	558	C	2	22	352	123	1228	1290	P		RMI	BNA	0	0	0	FRAG		1991	S		
267	558	C	2	23	426	230	0	1325	S		SORRENCA	BNA	0	0	0	FRAG		1991	S		
267	558	C	2	24	734	122	0	1256	S		CERAMICA	INFORME	0	0	0			1991	S		
267	558	C	2	25	769	7	0	1271	P		CALCARIA	BNA	0	0	0	FRAG		1991	S		
267	558	C	2	26	825	61	0	1254	S		RMI	BNA	0	0	0	FRAG		1991	S		
267	558	C	2	27	846	15	0	1260	P		CERAMICA	INFORME	0	0	0			1991	S		
267	558	C	2	28	717	483	0	1257	P		QUARSITA	BN1G	0	0	0			1991	S		
267	558	C	2	29	695	558	0	1279	P		INDET	BNA	0	0	0	FRAG		1991	S		
267	558	C	2	30	533	552	0	1276	P		CERAMICA	INFORME	0	0	0			1991	S		
267	558	C	2	31	450	401	0	1297	W		RMI	BNA	0	0	0	FRAG		1991	S		
267	558	C	2	32	424	375	0	1305	W		SORRENCA	BNA	0	0	0	NO RECUPERAT		1991	S		
267	558	C	2	33	303	484	0	1302	P		SORRENCA	BNA	0	0	0	FRAG		1991	S		
267	558	C	2	34	426	343	0	1315	V		SORRENCA	BNA	0	0	0	NO RECUPERAT		1991	S		
267	558	C	2	35	802	86	0	1281	S		CERAMICA	APLICA	0	0	0	LLENGUETA		1991	S		
267	558	C	2	36	629	14	0	1324	E		QUARS	BNA	0	0	0	FRAG		1991	S		
267	558	C	2	37	429	141	1284	1326	NW		SORRENCA	BNA	0	0	0	FRAG		1991	S		
267	558	C	2	38	286	11	0	1318	P		CERAMICA	INFORME	0	0	0			1991	S		
267	558	C	2	39	418	408	1293	1318	E		QUARSITA	BNA	0	0	0	FRAG		1991	S		
267	558	C	2	40	269	415	0	1317	P		SORRENCA	BNA	0	0	0	NO RECUPERAT		1991	S		
267	558	C	2	41	216	557	0	1305	NW		QUARS	BNA	0	0	0	FRAG		1991	S		
267	558	C	2	42	286	528	0	1311	W		CALCARIA	BNA	0	0	0	FRAG NO RECUPER		1991	S		
267	558	C	2	43	494	522	0	1335	P		QUARS	BNA	0	0	0	FRAC		1991	S		
267	558	C	2	44	732	448	0	1317	NE		OS	INDET	0	0	0	VARIS FRAGS		1991	S		
267	558	C	2	45	183	307	0	1355	NW		SORRENCA	BNA	0	0	0			1991	S		
267	558	C	2	46	225	286	0	1325	P		QUARS	BNA	0	0	0	FRAG		1991	S		
267	558	C	2	47	193	328	0	1342	NE		CERAMICA	INFORME	0	0	0	3 FRAGS		1991	S		
267	558	C	2	48	313	379	0	1368	SE		RMI	BNA	0	0	0	FRAG		1991	S		
267	558	C	2	49	421	30	0	1341	W		INDET	BNA	0	0	0	FRAG ALTERAT		1991	S		
267	558	C	2	50	193	646	0	1376	P		CERAMICA	VORA	0	0	0			1991	S		
267	558	C	2	51	191	615	0	1376	P		SILEX	BP2G	0	0	0			1991	S		
267	558	C	2	52	372	575	0	1390	V		QUARS	BNA	0	0	0	FRAG		1991	S		
267	558	C	2	53	98	459	0	1421	V		QUARS	FRAG	0	0	0			1991	S		
267	558	C	2	54	12	449	0	1412	NW		SORRENCA	BNA	0	0	0			1991	S		
267	558	C	2	55	39	387	0	1405	N		QUARS	BNA	0	0	0	FRAC		1991	S		
267	558	C	2	56	59	331	0	1400	NE		SORRENCA	BNA	0	0	0	FRAG		1991	S		
267	558	C	2	57	139	405	0	1387	SW		CALCARIA	BNA	0	0	0			1991	S		
267	558	C	2	58	295	84	0	1390	V		QUARS	BNA	0	0	0	4 FRAGS		1991	S		
267	558	C	2	59	612	58	0	1408	SW		SORRENCA	BNA	0	0	0	FRAG		1991	S		
267	558	C	2	60	695	29	0	1411	E		QUARS	BNA	0	0	0	FRAC		1991	S		
267	558	C	2	61	760	93	0	1415	P		QUARS	FRAG	0	0	0			1991	S		
267	558	C	2	62	861	843	0	1390	W		CERAMICA	VORA	0	0	0			1991	S		
267	558	C	2	63	347	30	0	1540	S		CERAMICA	INFORME	0	0	0			1991	S		
267	558	C	2	64	505	105	0	1487	W		RMI	BNA	0	0	0	FRAG		1991	S		
267	558	C	2	65	347	30	0	1492	SE		CERAMICA	PANXA	0	0	0			1991	S		
267	558	C	2	66	505	105	0	1496	SE		CONGLOME	BNA	0	0	0	MICROCONGL FRAG		1991	S		
267	558	C	2	67	927	377	0	1460			OS	INDET	0	0	0			1991	S		
267	558	C	2	68	900	263	0	1631	S		CERAMICA	INFORME	0	0	0			1991	S		
267	558	C	2	69	131	705	1341	1514	W		RMI	BNA	0	0	0			1991	S		

BOBILA MADURELL  
MAS DURAN  
Objectes Coordinats C5  
Campanya 1991

c	c	C	N										ALTERACIONS	P	D				
uX	uY	O	I	NUM.	X	Y	Zsup	Zinf	ORIENT	PENDENT	MATERIA	OBJECTE	LONG	AMPL	ESPE	OBSERVACIONS	ANY	U	I
a	a	N	V															N	B
d	d	J																T	U
267	558	C	3		70	674	973	0	1505	SW	QUARSITA	BNA	0	0	0	FRAG	1991	S	
267	558	C	3		71	792	890	0	1545	V	SORRENCA	BNA	0	0	0	FRAG	1991	S	
267	558	C	3		72	649	676	0	1540	NE	SORRENCA	BNA	0	0	0	ALTERAT	1991	S	
267	558	C	3		73	14	758	0	1565	SW	RMI	BNA	0	0	0	FRAG	1991	S	
267	558	C	3		74	164	721	0	1565	S	SORRENCA	BNA	0	0	0	2 FRAGS	1991	S	
267	558	C	3		75	730	708	0	1535	SW	CERAMICA	INFORME	0	0	0		1991	S	
267	558	C	3		76	917	877	0	1583	P	RMI	BNA	0	0	0	FRAC	1991	S	
267	558	C	3		77	965	729	0	1609	W	CERAMICA	INFORME	0	0	0		1991	S	
267	558	C	3		78	363	882	0	1601	SW	RMI	BNA	0	0	0	FRAG	1991	S	
267	558	C	3		79	299	881	0	1629	S	RMI	BNA	0	0	0	FRAG	1991	S	
267	558	C	3		80	604	597	1598	1640	SW	ESQUIST	BNA	0	0	0		1991	S	
267	558	C	3		81	822	590	0	1641	P	QUARS	BNA	0	0	0	FRAG	1991	S	
267	558	C	3		82	952	634	0	1637	SW	RMI	BNA	0	0	0	FRAC	1991	S	
267	558	C	3		83	695	605	0	1624	P	SORRENCA	BNA	0	0	0	FRAG ALTERAT	1991	S	
267	558	C	3		84	342	757	0	164	N	CERAMICA	INFORME	0	0	0		1991	S	
267	558	C	3		85	753	756	0	1683	NW	CALCARIA	BNA	0	0	0	FRAG ALTERAT	1991	S	
267	558	C	3		86	714	982	1597	1671	S	CONGLOME	BNA	0	0	0	MICROCONGL FRAG	1991	S	
267	558	C	3		87	253	997	0	1678	P	QUARSITA	BNA	0	0	0	FRAG	1991	S	
267	558	C	3		88	59	109	0	1718		OS	DET	0	0	0	DENT	1991	S	
267	558	C	3		89	65	35	0	1765	NW	OS	DET	0	0	0		1991	S	
267	558	C	3		90	750	756	0	1705		QUARS	BNA	0	0	0	FRAC	1991	S	
267	558	C	3		91	110	69	0	1760	N	OS	INDET	0	0	0		1991	S	
267	558	C	3		92	204	252	0	1745	V	RMI	BNA	0	0	0	FRAG	1991	S	
267	558	C	3		93	228	318	0	1764	N	CALCARIA	BNA	0	0	0	ALTERAT	1991	S	
267	558	C	3		94	889	679	0	1740	NE	CERAMICA	APLICA	0	0	0	LLENGETA	1991	S	
267	558	C	3		95	988	828	0	1736	NW	SORRENCA	BNA	0	0	0	FRAG	1991	S	
267	558	C	3		96	648	859	1599	1777	SW	CONGLOME	BNE	0	0	0	FRAG DE MOLI	1991	S	
267	558	C	3		97	584	932	0	1729	N	RMI	BNA	0	0	0	FRAG	1991	S	
267	558	C	3		98	313	346	0	1798		ORGANIC	CARBO	0	0	0		1991	S	
267	558	C	3		99	426	231	0	1797	P	RMI	BNA	0	0	0	ALTERAT	1991	S	
267	558	C	3		100	172	158	0	1809		OS	INDET	0	0	0		1991	S	
267	558	C	3		101	320	44	0	1810	E	RMI	BNA	0	0	0		1991	S	
267	558	C	3		102	295	7	0	1805	P	ESQUIST	BNA	0	0	0		1991	S	
267	558	C	3		103	830	6	0	1797	N	SORRENCA	BNA	0	0	0		1991	S	
267	558	C	3		104	400	20	0	1839		ORGANIC	CARBO	0	0	0		1991	S	
267	558	C	3		105	390	14	0	1832		ORGANIC	CARBO	0	0	0		1991	S	
267	558	C	3		106	139	244	0	1834	N	OS	DET	0	0	0		1991	S	
267	558	C	3		107	55	192	0	1855	NW	QUARSITA	BNA	0	0	0		1991	S	
267	558	C	3		108	375	176	0	1858	P	LIDITA	BNA	0	0	0		1991	S	
267	558	C	3		109	487	4	0	1871	P	RMI	BPF	0	0	0		1991	S	
267	558	C	3		110	498	84	0	1857	SW	OS	DET	0	0	0		1991	S	
267	559	C			1	643	112	0	1321	V	CERAMICA	INFORME	0	0	0	FRAGMENTAT	1991	S	
267	559	C	3		2	606	11	0	1499	P	QUARS	BNA	0	0	0	FRAG	1991	S	
267	559	C	3		3	932	7	0	1565	V	CERAMICA	INFORME	0	0	0		1991	S	
267	559	C	3		4	959	352	0	1620	W	CERAMICA	INFORME	0	0	0		1991	S	
267	559	C	3		5	604	13	0	1728	W	SORRENCA	BNA	0	0	0		1991	S	
267	559	C	3		6	565	44	0	1738	W	CALCARIA	BPI	0	0	0		1991	S	
267	559	C	3		7	814	545	0	1720	S	RMI	BNA	0	0	0	FRAG	1991	S	
267	559	C	3		8	812	413	0	1731	NW	CERAMICA	INFORME	0	0	0	VARIS FRAGS	1991	S	
267	559	C	3		9	941	114	0	1773	NW	QUARS	BNA	0	0	0	FRAC	1991	S	

155

BOBILA MADURELL  
MAS DURAN  
Objectes Coordenats C5  
Campanya 1991

c c C N												ALTERACIONS	P D				
uX	uY	O I	NUM.	X	Y	Zsup	Zinf	ORIENT	PENDENT	MATERIA	OBJECTE	LONG	AMPL	ESPE	OBSERVACIONS	ANY	U I
a	a	N V															N B
d	d	J															T U
267	559	C 3	10	626	328	0	1779	P		SORRENCA	BNA	0	0	0		1991	S
267	559	C 3	11	758	23	0	1793	E		CERAMICA	INFORME	0	0	0	VARIS FRAGS	1991	S
267	559	C 3	12	961	56	0	1817	NW		QUARSITA	BNA	0	0	0		1991	S
267	559	C 3	13	412	411	0	1802	SE		RMI	BNA	0	0	0		1991	S
267	559	C 3	14	784	115	0	1816	SW		RMI	BNA	0	0	0	FRAG	1991	S
267	559	C 3	15	996	203	0	1800	W		CERAMICA	APLICA	0	0	0	MAMELLO	1991	S
267	559	C 3	16	931	238	0	1821	W		CERAMICA	VORA	0	0	0		1991	S
267	559	C 3	17	746	171	0	1829	NW		ESQUIST	BNA	0	0	0	FRAG	1991	S
267	559	C 3	18	988	4	0	1823	S		RMI	BNA	0	0	0	FRAG	1991	S
267	559	C 3	19	656	247	0	1824	S		CALCARIA	BNA	0	0	0	ALTERAT	1991	S
267	559	C 3	20	869	286	0	1828	SE		CALCARIA	BNA	0	0	0	ALTERAT	1991	S
267	560	C	2	384	475	0	1591	NW		QUARS	BNA	0	0	0	FRAG	1991	S
267	560	C	3	466	395	0	1600	V		RMI	BNA	0	0	0	FRAG	1991	S
267	560	C	4	521	457	0	1600	V		SORRENCA	BNA	0	0	0		1991	S
267	560	C	5	623	522	0	1590	P		CONGLOME	BNA	0	0	0	MICROCONGLOME	1991	S
267	560	C	6	764	667	0	1519	NW		RMI	BNA	0	0	0	FRAG	1991	S
267	560	C	7	808	426	0	1580	NE		GRANIT	BNA	0	0	0	FRAG	1991	S
267	560	C 3	8	830	260	0	1611	P		CONGLOME	BNA	0	0	0	MICROCONGLOME	1991	S
267	560	C	9	887	489	0	1571	SE		SORRENCA	BNA	0	0	0	FRAG	1991	S
267	560	C	10	903	417	0	1630			CALCARIA	BNA	0	0	0		1991	S
267	560	C	11	986	502	0	1565	S		SORRENCA	BNA	0	0	0	FRAG ALTERAT	1991	S
268	554	C	1	141	700	0	1480	N-S	N	QUARS	BNA	0	0	0	FRAG	1991	S
268	554	C	2	46	946	0	1535	P		QUARS	BNA	0	0	0	FRAC	1991	S
268	555	C 3	1	65	212	1330	1374	W		RMI	BNA	0	0	0	FRAG	1991	S
268	555	C 3	2	296	376	0	1379	NE-SW	W	CERAMICA	INFORME	0	0	0		1991	S
268	555	C 3	3	681	882	0	1385			SILEX	BP2G	0	0	0		1991	S
268	555	C 3	4	230	450	0	1435	E-W	S	CERAMICA	INFORME	0	0	0		1991	S
268	555	C 3	5	855	701	0	1402	V		QUARS	BNA	0	0	0	FRAG	1991	S
268	555	C 3	6	359	392	0	1455	NW-SE	SW	RMI	BNA	0	0	0	FRAG	1991	S
268	555	C 3	7	372	770	0	1458	N-S	S	RMI	BNA	0	0	0	FRAG	1991	S
268	555	C 2	8	239	952	0	1440	N-S	P	QUARS	BNA	0	0	0		1991	S
268	555	C 2	9	160	876	0	1505	NW-SE	P	QUARSITA	BNA	0	0	0		1991	S
268	555	C 3	10	358	318	0	1573	NE-SW	W	RMI	BNA	0	0	0		1991	S
268	555	C 3	11	356	163	0	1577	N-S	W	CERAMICA	INFORME	0	0	0		1991	S
268	555	C 3	12	416	133	0	1585	NW-SE	W	RMI	BNA	0	0	0		1991	S
268	555	C 3	13	356	61	0	1570	NE-SW	W	RMI	BNA	0	0	0		1991	S
268	555	C 3	14	363	30	0	1590	N-S	P	RMI	BNA	0	0	0	FRAG	1991	S
268	555	C 3	15	557	228	0	1580	NW-SE	SW	QUARS	BPI	0	0	0	2 FRAGS	1991	S
268	555	C 3	16	831	855	0	1578	N-S	P	RMI	BNA	0	0	0	FRAG	1991	S
268	555	C 3	17	71	455	0	1565	N-S	P	RMI	BNA	0	0	0	FRAG	1991	S
268	555	C 3	18	72	522	0	1575	NE-SW	SW	CERAMICA	INFORME	0	0	0		1991	S
268	555	C 3	19	58	398	0	1602	E-W	P	CERAMICA	INFORME	0	0	0		1991	S
268	555	C 3	20	60	141	1582	1624	E		INDET	BNA	0	0	0	FRAG	1991	S
268	555	C 3	21	172	266	0	1630	NE-SW	P	CERAMICA	INFORME	0	0	0		1991	S
268	555	C 3	22	281	244	0	1640	NE-SW	V	QUARSITA	BNA	0	0	0		1991	S
268	555	C 3	23	923	633	0	1554	N-S	P	CERAMICA	PANXA	0	0	0	2 FRAGS	1991	S
268	555	C 2	24	133	901	0	1572	N-S	P	CERAMICA	PANXA	0	0	0	2 FRAGS	1991	S
268	555	C 3	25	281	244	0	1658	NE-SW	P	QUARS	BNA	0	0	0		1991	S
268	555	C 3	26	300	140	0	1644	NE-SW	NW	RMI	BNA	0	0	0	FRAG	1991	S
268	555	C 3	27	270	237	0	1649	N-S	S	CERAMICA	INFORME	0	0	0		1991	S

BOBILA MADURELL  
MAS DURAN  
Objectes Coordinats C5  
Campanya 1991

c	c	C	N															ALTERACIONS	P	D	
uX	uY	O	I	NUM.	X	Y	Zsup	Zinf	ORIENT	PENDENT	MATERIA	OBJECTE	LONG	AMPL	ESPE	OBSERVACIONS	ANY	U	I		
a	a	N	V																N	B	
d	d	J																		T	U
268	555	C	3	28	751	927	0	1626	N-S	S	CERAMICA	APLICA	0	0	0	LLENGETA	1991	S			
268	555	C	3	29	747	769	0	1678	NE-SW	P	CERAMICA	APLICA	0	0	0	DOBLE LLENGETA	1991	S			
268	555	C	3	30	43	200	0	1683	NE-SW	SW	RMI	BNA	0	0	0	FRAG	1991	S			
268	555	C	2	31	247	773	0	1680		V	CERAMICA	INFORME	0	0	0		1991	S			
268	555	C	3	32	222	99	0	1714		NW	CERAMICA	VORA	0	0	0		1991	S			
268	555	C	3	33	508	210	0	1672		V	CERAMICA	INFORME	0	0	0		1991	S			
268	555	C	3	34	383	434	0	1714		P	RMI	BNA	0	0	0	FRAG	1991	S			
268	555	C	3	35	389	465	0	1714		V	CERAMICA	CARENA	0	0	0		1991	S			
268	555	C	3	36	516	559	0	1691		N	CERAMICA	VORA	0	0	0		1991	S			
268	555	C	3	37	294	447	0	1713		P	SORRENCA	BNA	0	0	0		1991	S			
268	555	C	3	38	152	262	0	1712		N	SILEX	BN2G	0	0	0		1991	S			
268	555	C	3	39	190	397	0	1750		E	CERAMICA	PANXA	0	0	0	3 FRAGS	1991	S			
268	555	C	3	40	168	505	0	1745		P	CONGLOME	BNA	0	0	0		1991	S			
268	555	C	3	41	108	659	0	1726		P	CERAMICA	INFORME	0	0	0		1991	S			
268	555	C	3	42	747	789	0	1714		P	SILEX	BPF	0	0	0		1991	S			
268	555	C	3	43	132	387	0	1756		E	CERAMICA	INFORME	0	0	0		1991	S			
268	555	C	3	44	950	954	0	1757		E	INDET	BNA	0	0	0	ALTERAT	1991	S			
268	555	C	3	45	906	897	0	1770		P	QUARSITA	BNA	0	0	0		1991	S			
268	555	C	3	46	912	666	0	1766		N	OS	DET	0	0	0	VARIS FRAGS	1991	S			
268	555	C	3	47	82	281	0	1790		P	OS	DET	0	0	0	VARIS FRAGS	1991	S			
268	555	C	3	48	992	658	0	1795		P	CERAMICA	PANXA	0	0	0	3 FRAGMENTS	1991	S			
268	555	C		49	0	0	0	0			CERAMICA	INFORME	0	0	0	VARIS FRAGS	1991	S			
268	556	C	2	1	6	298	1262	1295		W	QUARSITA	BNA	0	0	0	FRAG	1991	S			
268	556	C	2	2	44	357	1257	1285		N	RMI	BNA	0	0	0		1991	S			
268	556	C	2	3	108	353	0	1307		W	CALCARIA	FRAG	0	0	0		1991	S			
268	556	C	2	4	199	323	0	1306		SW	RMI	BNA	0	0	0	FRAG	1991	S			
268	556	C	2	6	348	362	1244	1274		N	RMI	BNA	0	0	0		1991	S			
268	556	C	2	7	311	413	1238	1289		W	RMI	BNA	0	0	0	FRAG	1991	S			
268	556	C	2	8	509	415	0	1196		SE	RMI	BNA	0	0	0	FRAG	1991	S			
268	556	C	2	9	354	472	0	1294			CERAMICA	INFORME	0	0	0		1991	S			
268	556	C	2	10	311	413	1246	1298		N	QUARSITA	BNA	0	0	0	FRAG	1991	S			
268	556	C	2	11	242	469	1253	1284		W	CERAMICA	INFORME	0	0	0	ARGILA CUITA	1991	S			
268	556	C	2	12	161	439	1254	1303		W	RMI	BNA	0	0	0	FRAG	1991	S			
268	556	C	2	13	132	488	1279	1298		N	QUARSITA	BNA	0	0	0		1991	S			
268	556	C	2	14	177	514	0	1272		SW	CERAMICA	INFORME	0	0	0		1991	S			
268	556	C	2	15	143	538	1246	1271			QUARS	BNA	0	0	0	FRAG	1991	S			
268	556	C	2	16	9	448	1282	1337		W	SORRENCA	BNA	0	0	0		1991	S			
268	556	C	2	17	50	507	0	1287		W	QUARS	BNA	0	0	0	FRAG	1991	S			
268	556	C	2	18	60	554	0	1248		SW	CERAMICA	INFORME	0	0	0		1991	S			
268	556	C	2	19	5	570	1266	1283		W	ESQUIST	BNA	0	0	0		1991	S			
268	556	C	2	20	107	608	1197	1244			CALCARIA	FRAG	0	0	0		1991	S			
268	556	C	2	21	234	612	0	1257		S	CALCARIA	BNA	0	0	0	ALTERAT	1991	S			
268	556	C	2	22	263	586	1256	1270			CERAMICA	APLICA	0	0	0	LLENGETA	1991	S			
268	556	C	2	23	379	554	1264	1289		E	CALCARIA	BPI	0	0	0		1991	S			
268	556	C	2	24	535	545	0	1189		W	CONGLOME	BNA	0	0	0	MICROCONGL FRAG	1991	S			
268	556	C	2	25	647	581	1192	1226		SE	CALCARIA	BNA	0	0	0	FRAG	1991	S			
268	556	C	2	26	353	601	1267	1324			RMI	BNA	0	0	0		1991	S			
268	556	C	2	27	176	715	1285	1324		E	RMI	BNA	0	0	0	FRAG	1991	S			
268	556	C	2	28	34	710	1282	1290			CERAMICA	INFORME	0	0	0		1991	S			
268	556	C	2	29	128	766	0	1308		W	RMI	BNA	0	0	0	FRAG	1991	S			

157



BOBILA MADURELL  
MAS DURAN  
Objectes Coordinats C5  
Campanya 1991

c	c	C	N			ALTERACIONS							P D						
uX	uY	O	I	NUM.	X	Y	Zsup	Zinf	ORIENT	PENDENT	MATERIA	OBJECTE	LONG	AMPL	ESPE	OBSERVACIONS	ANY	U	I
a	a	N	V													N B			
d	d	J														T U			
268	556	C	2	30	284	765	1309	1323			RMI	BNA	0	0	0	FRAG	1991	S	
268	556	C	2	31	430	768	1217	1236		W	QUARS	BPI	0	0	0	FRAG	1991	S	
268	556	C	2	32	476	832	1222	1232			RMI	BNA	0	0	0	FRAG	1991	S	
268	556	C	2	33	434	862	1248	1272			RMI	BNA	0	0	0	FRAG	1991	S	
268	556	C	2	34	541	876	1268	1301			CALCARIA	BNA	0	0	0		1991	S	
268	556	C	2	35	499	921	0	1266			CERAMICA	INFORME	0	0	0	ARGILA CUITA	1991	S	
268	556	C	2	36	654	945	0	1318			QUARS	BNA	0	0	0		1991	S	
268	556	C	3	37	837	436	0	1335			CERAMICA	INFORME	0	0	0		1991	S	
268	556	C	2	38	486	382	1263	1280		S	SILEX	BPI	0	0	0		1991	S	
268	556	C	2	39	374	576	0	1235	NE-SW	P	CERAMICA	INFORME	0	0	0		1991	S	
268	556	C	2	40	533	612	0	1155	NW-SE	P	CERAMICA	INFORME	0	0	0		1991	S	
268	556	C	2	41	498	688	0	1180	NE-SW	SW	CERAMICA	INFORME	0	0	0		1991	S	
268	556	C	2	42	469	734	0	1187	NE-SW	SW	CALCARIA	CODOL	0	0	0		1991	S	
268	556	C	2	43	453	775	0	1189	E-W	E	CALCARIA	FRAG	0	0	0		1991	S	
268	556	C	2	44	381	802	1195	1230	E-W	NE	CALCARIA	FRAG	0	0	0		1991	S	
268	556	C	2	45	569	796	1154	1190	NE-SW	N	CALCARIA	FRAG	0	0	0		1991	S	
268	556	C	2	46	493	802	0	1194	NE-SW	SW	CALCARIA	CODOL	0	0	0		1991	S	
268	556	C	2	47	530	777	0	1190	NW-SE	SE	QUARS	FRAG	0	0	0	2 FRAGMENTS	1991	S	
268	556	C	2	48	460	892	0	1205	N-S	P	QUARS	FRAG	0	0	0		1991	S	
268	556	C	2	49	580	631	0	1212	NE-SW	SW	QUARS	FRAG	0	0	0		1991	S	
268	556	C	2	50	576	680	0	1190	NE-SW	P	CALCARIA	CODOL	0	0	0		1991	S	
268	556	C	2	51	42	949	0	1265	NW-SE	SE	CALCARIA	FRAG	0	0	0		1991	S	
268	556	C	2	52	199	248	0	1280	N-S	W	CERAMICA	INFORME	0	0	0		1991	S	
268	556	C	2	53	576	680	0	1285	E-W	P	CERAMICA	INFORME	0	0	0		1991	S	
268	556	C	2	54	126	391	0	1275	NE-SW	P	SORRENCA	FRAG	0	0	0		1991	S	
268	556	C	2	55	41	469	0	1300	E-W	P	RMI	BNA	0	0	0	FRAG	1991	S	
268	556	C	2	56	190	455	0	1284	N-S	P	SORRENCA	BNA	0	0	0	FRAG ALTERAT	1991	S	
268	556	C	2	57	207	550	0	1285	NW-SE	SW	RMI	BNA	0	0	0	FRAG	1991	S	
268	556	C	2	58	233	594	0	1270	NW-SE	SW	QUARS	BNA	0	0	0		1991	S	
268	556	C	2	59	133	652	0	1260	NW-SE	SE	SORRENCA	BNA	0	0	0	FRAG ALTERAT	1991	S	
268	556	C	2	60	199	664	0	1230	N-S	S	SORRENCA	FRAG	0	0	0		1991	S	
268	556	C	2	61	241	693	0	1255	NE-SW	NE	CALCARIA	BP	0	0	0		1991	S	
268	556	C	2	62	227	750	0	1260	NE-SW	SE	SORRENCA	BNA	0	0	0		1991	S	
268	556	C	2	63	166	768	0	1280	E-W	E	RMI	BNA	0	0	0	FRAG	1991	S	
268	556	C	2	64	59	856	0	1270	NE-SW	P	RMI	BNA	0	0	0	FRAG	1991	S	
268	556	C	2	65	64	924	0	1280	NE-SW	W	RMI	BNA	0	0	0	FRAG ALTERAT	1991	S	
268	556	C	2	66	103	995	0	1280	NE-SW	SW	CALCARIA	BNA	0	0	0		1991	S	
268	556	C	2	67	0	0	0	1300			CERAMICA	INFORME	0	0	0		1991	S	
268	556	C	2	68	361	192	0	1333		NW	RMI	BNA	0	0	0	FRAG	1991	S	
268	556	C	2	69	159	244	0	1351		V	CALCARIA	BNA	0	0	0	FRAG ALTERAT	1991	S	
268	556	C	2	70	264	351	0	1349	E-W	NW	CALCARIA	BNA	0	0	0	FRAG NO RECUPER	1991	S	
268	556	C	2	71	267	287	0	1357	E-W	S	SILEX	BPI	0	0	0		1991	S	
268	556	C	2	72	139	795	0	1337	N-S	SW	QUARS	BPI	0	0	0		1991	S	
268	556	C	2	73	212	398	0	1365	E-W	S	RMI	BNA	0	0	0	FRAG	1991	S	
268	556	C	2	74	130	465	1336	1373	E-W	W	RMI	BNA	0	0	0	FRAG	1991	S	
268	556	C	2	75	318	385	0	1375			CERAMICA	INFORME	0	0	0		1991	S	
268	556	C	2	76	111	708	1310	1362		NW	QUARS	BNA	0	0	0	FRAG	1991	S	
268	556	C	2	77	115	407	1334	1388	E-W	W	RMI	BNA	0	0	0	FRAG	1991	S	
268	556	C	2	78	515	226	0	1390	NW-SE	NW	RMI	BNA	0	0	0	FRAG	1991	S	
268	556	C	2	79	346	318	0	1363	N-S	P	RMI	BNA	0	0	0	FRAG	1991	S	



01/28/92

BOBILA MADURELL  
MAS DURAN  
Objectes Coordinats C5  
Campanya 1991

c	c	C	N													ALTERACIONS			P	D	
wX	uY	O	I	NUM.	X	Y	Zsup	Zinf	ORIENT	PENDENT	MATERIA	OBJECTE	LONG	AMPL	ESPE	OBSERVACIONS	ANY	U	I		
a	a	N	V																N	B	
d	d	J																	T	U	
268	556	C	3	130	298	448		0	1732	P	QUARS	BNA	0	0	0		1991	S			
268	556	C	3	131	709	137		0	1785	SW	CERAMICA	INFORME	0	0	0		1991	S			
268	556	C	3	132	908	447		0	1783	NE	CERAMICA	INFORME	0	0	0	2 FRAGS	1991	S			
268	556	C	3	133	333	572		0	1785	NW	RMI	BNA	0	0	0	FRAG	1991	S			
268	556	C	3	134	79	854		0	1768	P	QUARS	BNA	0	0	0	FRAC	1991	S			
268	556	C	3	135	933	862		0	1783	NW	SILEX	BP	0	0	0		1991	S			
268	556	C	3	136	952	833		0	1782	V	CALCARIA	BNA	0	0	0		1991	S			
268	556	C	3	137	965	766		0	1843	NW	RMI	BNA	0	0	0		1991	S			
268	556	C	3	138	980	632		0	1844	NW	CERAMICA	VORA	0	0	0	2 MUGRONS, FONTS	1991	S			
268	556	C	3	139	964	528		0	1871	P	OS	DET	0	0	0	MD Inf	1991	S			
268	557	C		1	419	79		0	1197	NE-SW	S	QUARS	FRAG	0	0	0		1991			
268	557	C		2	825	77		0	1203	NE-SW	S	QUARS	FRAG	0	0	0		1991			
268	557	C		3	522	270		0	1167	NE-SW	SW	QUARS	FRAG	0	0	0		1991			
268	557	C		4	419	79		0	1134	NE-SW	SE	CALCARIA	CODOL	0	0	0		1991			
268	557	C		5	610	374		0	1150	E-W	E	CALCARIA	FRAG	0	0	0		1991			
268	557	C		7	825	77		0	1118	N-S	E	CERAMICA	INFORME	0	0	0		1991	S		
268	557	C		8	436	473		0	1130	NW-SE	E	CALCARIA	CODOL	0	0	0		1991			
268	557	C		9	522	270		0	1140	N-S	NE	QUARS	FRAG	0	0	0		1991			
268	557	C		10	883	586		0	1155	NE-SW	W	CALCARIA	FRAG	0	0	0		1991			
268	557	C		11	780	525		0	1173	E-W	S	CERAMICA	INFORME	0	0	0		1991	S		
268	557	C		12	36	557	1203	1247	NW-SE	NW	CALCARIA	FRAG	0	0	0		1991				
268	557	C		13	90	629		0	1185		INDET	FRAG	0	0	0		1991				
268	557	C		14	109	642		0	1191	NE-SW	NE	CALCARIA	FRAG	0	0	0		1991			
268	557	C		15	367	768		0	1207		CERAMICA	INFORME	0	0	0		1991	S			
268	557	C		16	506	813		0	1127	NE-SW	NW	QUARS	FRAG	0	0	0		1991			
268	557	C		17	492	839		0	1136	NE-SW	NW	CERAMICA	INFORME	0	0	0		1991	S		
268	557	C		18	508	991	1136	1177	E-W	P	CALCARIA	FRAG	0	0	0		1991				
268	557	C	2	19	478	383		0	1265	NW-SE	N	RMI	BNA	0	0	0	FRAG	1991	S		
268	557	C	2	20	552	588		0	1244		OS	DET	0	0	0	DENT	1991	S			
268	557	C	3	21	678	673		0	1259		SILEX	BN2G	0	0	0	PATINAT	1991	S			
268	557	C	3	22	749	581		0	1243	NE-SW	P	CERAMICA	INFORME	0	0	0		1991	S		
268	557	C	3	23	993	268		0	1240	N-S	E	CERAMICA	INFORME	0	0	0	VARIS FRAGS.	1991	S		
268	557	C	2	24	44	899		0	1166	NE-SW	SW	CERAMICA	INFORME	0	0	0		1991	S		
268	557	C	2	25	127	979		0	1314	NW-SE	N	CERAMICA	INFORME	0	0	0	DOS FRAGS	1991	S		
268	557	C	2	26	252	413		0	1330	NE-SW	SW	RMI	BNA	0	0	0	FRAG	1991	S		
268	557	C	2	27	531	638		0	1302	E-W	SW	CERAMICA	INFORME	0	0	0		1991	S		
268	557	C	3	28	985	204	1311	1376	N-S	S	RMI	BNA	0	0	0	FRAG	1991	S			
268	557	C	2	29	177	220		0	1346	N-S	V	INDET	BNA	0	0	0	FRAC	1991	S		
268	557	C	2	30	72	210		0	1328	N-S	W	RMI	BNA	0	0	0	FRAG	1991	S		
268	557	C	2	31	142	419	1319	1351	E-W	E	RMI	BNA	0	0	0	FRAG	1991	S			
268	557	C	2	32	150	473		0	1420		NW	CERAMICA	APLICA	0	0	0	MUGRO	1991	S		
268	557	C	2	33	355	357		0	1427		P	CERAMICA	INFORME	0	0	0		1991	S		
268	557	C	2	34	75	281		0	1395		NW	QUARSITA	BNA	0	0	0	FRAG	1991	S		
268	557	C	3	35	845	514		0	1395		V	OS	INDET	0	0	0		1991	S		
268	557	C	2	36	88	386		0	1400		E	CERAMICA	INFORME	0	0	0		1991	S		
268	557	C	2	37	232	595		0	1420		V	SILEX	BPF	0	0	0		1991	S		
268	557	C	2	38	410	827		0	1423		SE	CALCARIA	BNA	0	0	0		1991	S		
268	557	C	2	39	400	603		0	1440		SE	QUARS	BNA	0	0	0	FRAC	1991	S		
268	557	C	2	40	159	339		0	1418		SW	OS	INDET	0	0	0		1991	S		
268	557	C	2	41	85	90		0	1489		P	SORRENCA	BNA	0	0	0	FRAG	1991			

01/28/92

BOBILA MADURELL  
MAS DURAN  
Objectes Coordenats C5  
Campanya 1991

														ALTERACIONS		P D							
c	c	C	N	NUM.	X	Y	Zsup	Zinf	ORIENT	PENDENT	MATERIA	OBJECTE	LONG	AMPL	ESPE	OBSERVACIONS	ANY	U	I	N	B	T	U
uX	uY	O	I																				
a	a	N	V																				
d	d	J																					
268	557	C	2	42	239	205	0	1454	S		CALCARIA	BNA	0	0	0	FRAC	1991						
268	557	C	2	43	221	323	0	1467	P		OS	INDET	0	0	0		1991	S					
268	557	C	2	44	18	297	0	1464	E		QUARS	BNA	0	0	0	FRAG	1991	S					
268	557	C	2	45	387	885	0	1449	P		SORRENCA	BNA	0	0	0	FRAG	1991						
268	557	C	2	46	86	942	0	1481	S		CERAMICA	VORA	0	0	0		1991	S					
268	557	C	2	47	279	705	0	1468	SW		RMI	BNA	0	0	0	FRAG	1991	S					
268	557	C	2	48	221	578	0	1463	P		CERAMICA	INFORME	0	0	0	TERRA CUITA	1991	S					
268	557	C	2	49	119	488	0	1506	SW		RMI	BNA	0	0	0	FRAG	1991	S					
268	557	C	2	50	474	335	1365	1477	S		CONGLOME	BNA	0	0	0	MICROCON FRAG	1991						
268	557	C	2	51	448	245	0	1499	W		SORRENCA	BNA	0	0	0	FRAG	1991						
268	557	C	2	52	240	12	0	1546	NW		RMI	BNA	0	0	0	FRAG	1991	S					
268	557	C	3	53	881	449	0	1477	P		SORRENCA	BNA	0	0	0		1991	S					
268	557	C	3	54	945	473	1378	1470	P		QUARS	BNA	0	0	0	FRAG	1991	S					
268	557	C	3	55	988	458	0	1469	P		SORRENCA	BNA	0	0	0	FRAG	1991	S					
268	557	C	3	56	0	0	0	1376	SW		CERAMICA	INFORME	0	0	0		1991	S					
268	557	C	3	57	197	651	0	1563	W		CERAMICA	INFORME	0	0	0		1991	S					
268	557	C	3	58	202	690	0	1615	W		RMI	BNA	0	0	0	FRAG	1991	S					
268	557	C	3	59	189	677	0	1601	W		CERAMICA	INFORME	0	0	0		1991	S					
268	557	C	3	60	222	607	0	1603	SW		QUARSITA	BPI	0	0	0		1991	S					
268	557	C	3	61	164	484	0	1611	SW		CERAMICA	INFORME	0	0	0		1991	S					
268	557	C	3	62	186	425	0	1579	W		SILEX	BP	0	0	0		1991	S					
268	557	C	3	63	899	571	0	1549	P		QUARS	BPI	0	0	0	FRAG	1991	S					
268	557	C	3	65	796	496	1498	1580	E		ESQUIST	BNA	0	0	0	FRAG	1991	S					
268	557	C	3	66	664	530	1425	1624	S		RMI	BNA	0	0	0		1991	S					
268	557	C	3	67	894	584	1580	1681	W		SORRENCA	BNA	0	0	0	FRAG	1991	S					
268	557	C	3	68	754	555	1596	1653	V		SORRENCA	BNA	0	0	0		1991	S					
268	557	C	3	69	781	429	1541	1741	V		CALCARIA	BNA	0	0	0	ALTERAT	1991	S					
268	557	C	3	70	725	267	1581	1683	P		CONGLOME	BNA	0	0	0	MICROCONGL FRAG	1991	S					
268	557	C	3	71	712	683	1594	1706	S		CONGLOME	BNA	0	0	0	MICROCONGL FRAG	1991	S					
268	557	C	3	72	589	214	1614	1715	SW		CONGLOME	BNA	0	0	0	MICROCONGL FRAG	1991	S					
268	557	C	3	73	471	269	1607	1733	P		CONGLOME	BNA	0	0	0	MICROCONGL FRAG	1991	S					
268	557	C	3	74	411	449	1613	1738	V		CONGLOME	BNA	0	0	0		1991	S					
268	557	C	3	75	526	627	1616	1620	P		RMI	BNA	0	0	0	FRAG	1991	S					
268	557	C	3	76	602	470	1610	1734	P		ESQUIST	BNA	0	0	0	FRAC	1991	S					
268	557	C	3	77	731	557	0	1671	P		QUARS	BPI	0	0	0		1991	S					
268	557	C	3	78	763	563	0	1685	V		RMI	BNA	0	0	0	FRAC	1991	S					
268	557	C	3	79	846	546	0	1709	V		QUARS	BNA	0	0	0	FRAC	1991						
268	557	C	3	80	856	184	0	1684	P		QUARS	BPF	0	0	0		1991	S					
268	557	C	3	81	258	476	0	1705	P		CALCARIA	BNA	0	0	0	FRAG	1991	S					
268	557	C	3	82	657	594	0	1707	P		RMI	BNA	0	0	0	FRAC	1991						
268	557	C	3	83	756	338	1660	1729	P		CONGLOME	BNA	0	0	0	FRAG	1991	S					
268	557	C	3	84	45	902	0	1779	W		OS	INDET	0	0	0		1991	S					
268	557	C	3	85	311	228	0	1796	W		RMI	BNA	0	0	0	FRAG	1991	S					
268	557	C	3	86	744	332	0	1781	W		QUARS	BNA	0	0	0		1991	S					
268	557	C	3	87	732	564	0	1770	N		INDET	BNA	0	0	0	ALTERAT	1991	S					
268	557	C	3	88	433	453	0	1814	W		RMI	BNA	0	0	0	FRAG	1991	S					
268	557	C	3	89	166	310	0	1872	E		RMI	BNA	0	0	0	FRAG	1991	S					
268	557	C	3	90	423	266	0	1814	W		QUARS	BNA	0	0	0	FRAG	1991	S					
268	557	C	3	91	547	359	0	1823	N		CALCARIA	BP	0	0	0		1991						
268	557	C	3	92	431	673	0	1847	E		SORRENCA	BNA	0	0	0		1991	S					

161





## ANNEX IIIb

**INVENTARI DELS ENTERRAMENTS I DE LES ESTRUCTURES DE  
EMMAGATZEMATGE**

BOBILA MADURELL  
MAS DURAN  
campanya 1991

E.E. NUM.	X	Y	Zsup	Zinf/ Talla	ORIENT SECTOR	PENDENT MATERIA	OBJECTE	LONG	AMPL	ESPE	ALTERACIONS	P D	
											OBSERVACIONS	ANY U I N B T U	
101	1	0	0	0	19	CERAMICA	INFORME	0	0	0		1991 S	
101	2	0	0	0	19	CERAMICA	INFORME	0	0	0		1991 S	
101	3	0	0	0	19	CERAMICA	INFORME	0	0	0		1991 S	
101	4	0	0	0	19	CERAMICA	INFORME	0	0	0		1991 S	
101	5	0	0	0	19	CERAMICA	INFORME	0	0	0		1991 S	
101	6	0	0	0	19	CERAMICA	INFORME	0	0	0		1991 S	
101	7	0	0	0	19	CERAMICA	INFORME	0	0	0		1991 S	
101	8	0	0	0	19	CERAMICA	INFORME	0	0	0		1991 S	
101	9	0	0	0	19	CERAMICA	INFORME	0	0	0	FRAG	1991 S	
101	10	0	0	0	19	CERAMICA	INFORME	0	0	0		1991 S	
101	11	0	0	0	19	CERAMICA	INFORME	0	0	0		1991 S	
101	12	0	0	0	19	CERAMICA	INFORME	0	0	0		1991 S	
101	13	0	0	0	19	CERAMICA	INFORME	0	0	0		1991 S	
101	14	0	0	0	19	CERAMICA	INFORME	0	0	0	FRAG	1991 S	
101	15	0	0	0	19	CERAMICA	INFORME	0	0	0		1991 S	
101	16	0	0	0	19	CERAMICA	INFORME	0	0	0		1991 S	
101	17	0	0	0	19	CERAMICA	INFORME	0	0	0	FRAG	1991 S	
101	18	0	0	0	19	CERAMICA	INFORME	0	0	0		1991 S	
101	19	0	0	0	19	CERAMICA	INFORME	0	0	0		1991 S	
101	20	0	0	0	19	CERAMICA	INFORME	0	0	0		1991 S	
101	21	0	0	0	20	CERAMICA	INFORME	0	0	0		1991 S	
101	22	0	0	0	20	CERAMICA	INFORME	0	0	0	FRAG	1991 S	
101	23	0	0	0	20	CERAMICA	INFORME	0	0	0		1991 S	
101	24	0	0	0	20	CERAMICA	INFORME	0	0	0		1991 S	
101	25	0	0	0	20	CERAMICA	INFORME	0	0	0		1991 S	
101	26	0	0	0	20	CERAMICA	INFORME	0	0	0	FRAG	1991 S	
101	27	0	0	0	20	CERAMICA	INFORME	0	0	0		1991 S	
101	28	0	0	0	20	CERAMICA	INFORME	0	0	0	FRAG	1991 S	
101	29	0	0	0	20	SE	CERAMICA	INFORME	0	0	0		1991 S
101	30	0	0	0	20	CERAMICA	INFORME	0	0	0		1991 S	
101	31	0	0	0	20	SW	CERAMICA	INFORME	0	0	0		1991 S
101	32	0	0	0	20	SW	CERAMICA	INFORME	0	0	0 2 FRAGS		1991 S
101	33	0	0	0	20	SW	CERAMICA	INFORME	0	0	0		1991 S
101	34	0	0	0	20	SW	CERAMICA	INFORME	0	0	0		1991 S
101	35	0	0	0	20	SW	CERAMICA	INFORME	0	0	0		1991 S
101	36	0	0	0	20	SW	CERAMICA	VORA	0	0	0		1991 S
101	37	0	0	0	20	SW	CERAMICA	INFORME	0	0	0		1991 S
101	38	0	0	0	20	SW	CERAMICA	INFORME	0	0	0		1991 S
101	39	0	0	0	20	SW	CERAMICA	INFORME	0	0	0		1991 S
101	40	0	0	0	20	SW	QUARS	BP2G	0	0	0		1991 S
101	41	0	0	0	20	SW	SILEX	BP	0	0	0		1991 S
101	42	0	0	0	19	QUARS	BNA	0	0	0	FRAG		1991 S
101	43	0	0	0	19	RMI	BNA	0	0	0			1991 S
101	44	0	0	0	19	RMI	BNA	0	0	0			1991 S
101	45	0	0	0	19	QUARS	BNA	0	0	0			1991 S
101	46	0	0	0	19	RMI	BNA	0	0	0	FRAG		1991 S
101	47	0	0	0	19	RMI	BNA	0	0	0	FRAG		1991 S
101	48	0	0	0	19	CONGLOME	BNA	0	0	0	FRAG		1991 S
101	49	0	0	0	19	RMI	BNA	0	0	0	FRAG		1991 S
101	50	0	0	0	19	QUARS	BNA	0	0	0	FRAG		1991 S
101	51	0	0	0	19	RMI	BNA	0	0	0			1991 S

BOBILA MADURELL  
MAS DURAN  
campanya 1991

E.E. NUM.	X	Y	Zsup	Zinf/ Talla	ORIENT	PENDENT SECTOR	MATERIA	OBJECTE	LONG	AMPL	ESPE	ALTERACIONS OBSERVACIONS	P D				
													ANY	U	I	B	
101	52	0	0	0			CONGLOME	BNA	0	0	0		1991	S			
101	53	0	0	0			CALCARIA	BNA	0	0	0		1991	S			
101	54	0	0	0			RMI	BNA	0	0	0		1991	S			
101	55	0	0	0			SORRENCA	BNA	0	0	0	FRAG	1991	S			
101	56	0	0	0			RMI	BNA	0	0	0	FRAG	1991	S			
101	57	0	0	0			SORRENCA	BNA	0	0	0	FRAG	1991	S			
101	58	0	0	0			RMI	BNA	0	0	0	FRAC	1991	S			
101	59	0	0	0			RMI	BNA	0	0	0	FRAC	1991	S			
101	60	0	0	0			RMI	BNA	0	0	0	FRAC	1991	S			
101	61	0	0	0			SORRENCA	BNA	0	0	0		1991	S			
101	62	0	0	0			RMI	BNA	0	0	0	FRAG	1991	S			
101	63	0	0	0			RMI	BNA	0	0	0	FRAG	1991	S			
101	64	0	0	0			GRANIT	BNA	0	0	0	FRAG	1991	S			
101	65	0	0	0			ESQUIST	BNA	0	0	0	FRAG	1991	S			
101	66	0	0	0			RMI	BNA	0	0	0	FRAG	1991	S			
101	67	0	0	0			RMI	BNA	0	0	0	FRAG	1991	S			
101	68	0	0	0			CALCARIA	BNA	0	0	0	FRAG	1991	S			
101	69	0	0	0			CONGLOME	BNA	0	0	0	FRAG	1991	S			
101	70	0	0	0			RMI	BNA	0	0	0		1991	S			
101	71	0	0	0			RMI	BNA	0	0	0		1991	S			
101	72	0	0	0			RMI	BNA	0	0	0	FRAG	1991	S			
101	73	0	0	0			SORRENCA	BNA	0	0	0	FRAG	1991	S			
101	74	0	0	0		SW	SILEX	BNA	0	0	0	FRAC	1991	S			
101	75	0	0	0		SW	RMI	BNA	0	0	0	FRAC	1991	S			
101	76	0	0	0		SW	QUARS	BPI	0	0	0		1991	S			
101	77	0	0	0		SW	SORRENCA	BNA	0	0	0	FRAG	1991	S			
101	78	0	0	0			RMI	BNA	0	0	0	FRAG	1991	S			
101	79	0	0	0			GRANIT	BNA	0	0	0	FRAG	1991	S			
101	80	0	0	0		SE	GRANIT	BNA	0	0	0	FRAG	1991	S			
101	81	0	0	0			SORRENCA	BNA	0	0	0		1991	S			
101	82	0	0	0			SORRENCA	BNA	0	0	0	FRAG	1991	S			
101	83	0	0	0		SE	RMI	BNA	0	0	0	FRAG	1991	S			
101	84	0	0	0		SE	QUARS	BNA	0	0	0	FRAG	1991	S			
101	85	0	0	0		SE	RMI	BNA	0	0	0	FRAG	1991	S			
101	86	0	0	0		SE	RMI	BNA	0	0	0		1991	S			
101	87	0	0	0		SE	RMI	BNA	0	0	0	FRAG	1991	S			
101	88	0	0	0		SE	RMI	BNA	0	0	0	FRAG	1991	S			
101	89	0	0	0		SE	RMI	BNA	0	0	0	FRAG	1991	S			
101	90	0	0	0		SE	QUARS	BNA	0	0	0	FRAG	1991	S			
101	91	0	0	0			OS	DET	0	0	0	DENT	1991	S			
101	92	0	0	0			OS	INDET	0	0	0	FRAG	1991	S			
101	93	0	0	0			OS	INDET	0	0	0	FRAG	1991	S			
101	94	0	0	0		SE	OS	INDET	0	0	0		1991	S			
101	95	0	0	0			ORGANIC	MOLUSC	0	0	0		1991	S			
101	96	0	0	0			CALCARIA	BNA	0	0	0		1991	S			
102	1	0	0	0			CERAMICA	APLICA	0	0	0	LLENGETA	1991	S			
102	2	0	0	0		E	CERAMICA	INFORME	0	0	0	FRAG	1991	S			
102	3	0	0	0			CERAMICA	INFORME	0	0	0	FRAG	1991	S			
102	4	0	0	0		W	CERAMICA	CARENA	0	0	0		1991	S			
102	5	0	0	0			CERAMICA	INFORME	0	0	0		1991	S			
102	6	0	0	0			CERAMICA	FONS	0	0	0		1991	S			

165



BOBILA MADURELL  
MAS DURAN  
campanya 1991

E.E. NUM.	X	Y	Zsup	Zinf/ Talla	ORIENT	PENDENT SECTOR	MATERIA	OBJECTE	LONG	AMPL	ESPE	ALTERACIONS	P D
												OBSERVACIONS	ANY U I N B T U
102	7	0	0	0	19		CERAMICA	NANSA	0	0	0		1991 S
102	8	0	0	0	19		CERAMICA	VORA	0	0	0	MUGRO	1991 S
102	9	0	0	0	19		CERAMICA	VORA	0	0	0		1991 S
102	10	0	0	0	19		CERAMICA	INFORME	0	0	0	FRAG	1991 S
102	11	0	0	0	19		CERAMICA	INFORME	0	0	0	FRAG	1991 S
102	12	0	0	0	19		CERAMICA	INFORME	0	0	0		1991 S
102	13	0	0	0	19		CERAMICA	INFORME	0	0	0		1991 S
102	14	0	0	0	19		CERAMICA	INFORME	0	0	0	FRAG	1991 S
102	15	0	0	0	19	E	CERAMICA	INFORME	0	0	0		1991 S
102	16	0	0	0	19	E	CERAMICA	INFORME	0	0	0		1991 S
102	17	0	0	0	19	E	CERAMICA	INFORME	0	0	0		1991 S
102	18	0	0	0	19	W	CERAMICA	INFORME	0	0	0		1991 S
102	19	0	0	0	19	W	CERAMICA	INFORME	0	0	0		1991 S
102	20	0	0	0	19	W	CERAMICA	INFORME	0	0	0		1991 S
102	21	0	0	0	19	E	CERAMICA	INFORME	0	0	0		1991 S
102	22	0	0	0	19	W	CERAMICA	INFORME	0	0	0		1991 S
102	23	0	0	0	19	E	CERAMICA	INFORME	0	0	0		1991 S
102	24	0	0	0	20		CERAMICA	INFORME	0	0	0		1991 S
102	25	0	0	0	20		CERAMICA	CARENA	0	0	0		1991 S
102	26	0	0	0	20		CERAMICA	INFORME	0	0	0		1991 S
102	27	0	0	0	20		CERAMICA	INFORME	0	0	0		1991 S
102	28	0	0	0	20		CERAMICA	INFORME	0	0	0		1991 S
102	29	0	0	0	20		CERAMICA	INFORME	0	0	0		1991 S
102	30	0	0	0	20		CERAMICA	INFORME	0	0	0		1991 S
102	31	0	0	0	20		CERAMICA	INFORME	0	0	0		1991 S
102	32	0	0	0	20		CERAMICA	INFORME	0	0	0		1991 S
102	33	0	0	0	20		CERAMICA	INFORME	0	0	0		1991 S
102	34	0	0	0	20		CERAMICA	INFORME	0	0	0		1991 S
102	35	0	0	0	20		CERAMICA	INFORME	0	0	0		1991 S
102	36	0	0	0	20		CERAMICA	INFORME	0	0	0		1991 S
102	37	0	0	0	20		CERAMICA	INFORME	0	0	0		1991 S
102	38	0	0	0	20		CERAMICA	INFORME	0	0	0		1991 S
102	39	0	0	0	20		CERAMICA	INFORME	0	0	0		1991 S
102	40	0	0	0	20	E	CERAMICA	INFORME	0	0	0		1991 S
102	41	0	0	0	20	W	CERAMICA	INFORME	0	0	0		1991 S
102	42	0	0	0	20	W	CERAMICA	INFORME	0	0	0		1991 S
102	43	0	0	0	20	W	CERAMICA	INFORME	0	0	0		1991 S
102	44	0	0	0	20	W	CERAMICA	INFORME	0	0	0		1991 S
102	45	0	0	0	20	W	CERAMICA	INFORME	0	0	0		1991 S
102	46	0	0	0	18	W	CERAMICA	INFORME	0	0	0		1991 S
102	47	0	0	0	21		CERAMICA	INFORME	0	0	0		1991 S
102	48	0	0	0	21		CERAMICA	INFORME	0	0	0		1991 S
102	49	0	0	0	20		CERAMICA	INFORME	0	0	0		1991 S
102	50	0	0	0	21		CERAMICA	INFORME	0	0	0		1991 S
102	51	0	0	0	21		CERAMICA	VORA	0	0	0		1991 S
102	52	0	0	0	21		CERAMICA	INFORME	0	0	0	FRAG	1991 S
102	53	0	0	0	21		CERAMICA	CARENA	0	0	0		1991 S
102	54	0	0	0	21		CERAMICA	INFORME	0	0	0		1991 S
102	55	0	0	0	20		CERAMICA	INFORME	0	0	0	FRAG	1991 S
102	56	0	0	0	20	W	CERAMICA	INFORME	0	0	0		1991 S
102	57	0	0	0	19	W	CERAMICA	INFORME	0	0	0		1991 S

BOBILA MADURELL  
MAS DURAN  
campanya 1991

E.E. NUM.	X	Y	Zsup	Zinf/ Talla	ORIENT SECTOR	PENDENT MATERIA	OBJECTE	LONG	AMPL	ESPE	ALTERACIONS	P D
											OBSERVACIONS	ANY U I N B T U
102	58	0	0	0	19	W	SILEX	BN2G	0	0	0 LAMINA	1991 S
102	59	0	0	0	20	W	SILEX	BN2G	0	0	0	1991 S
102	60	0	0	0	0		GRANIT	BNA	0	0	0 FRAG	1991 S
102	61	0	0	0	0		GRANIT	BNA	0	0	0 FRAG	1991 S
102	62	0	0	0	18	W	CONGLOME	BNA	0	0	0	1991 S
102	63	0	0	0	18	W	SORRENCA	BNA	0	0	0 FRAG	1991 S
102	64	0	0	0	18	W	SORRENCA	BNA	0	0	0 FRAG	1991 S
102	65	0	0	0	18		RMI	BNA	0	0	0 FRAG	1991 S
102	66	0	0	0	18		CALCARIA	BNA	0	0	0	1991 S
102	67	0	0	0	18		CALCARIA	BNA	0	0	0	1991 S
102	68	0	0	0	18		RMI	BNA	0	0	0	1991 S
102	69	0	0	0	18		RMI	BNA	0	0	0	1991 S
102	70	0	0	0	18		RMI	BNA	0	0	0	1991 S
102	71	0	0	0	18		QUARS	BNA	0	0	0	1991 S
102	72	0	0	0	19		RMI	BNA	0	0	0 FRAG	1991 S
102	73	0	0	0	19		CALCARIA	BNA	0	0	0	1991 S
102	74	0	0	0	19		SORRENCA	BNA	0	0	0 FRAG	1991 S
102	75	0	0	0	19		RMI	BNA	0	0	0	1991 S
102	76	0	0	0	19		QUARS	BPI	0	0	0	1991 S
102	77	0	0	0	19		SORRENCA	BNA	0	0	0 FRAG	1991 S
102	78	0	0	0	19		CONGLOME	BNA	0	0	0 FRAG	1991 S
102	79	0	0	0	19		QUARS	BNA	0	0	0 FRAG	1991 S
102	80	0	0	0	19		RMI	BNA	0	0	0 FRAG	1991 S
102	81	0	0	0	19		RMI	BNA	0	0	0 FRAG	1991 S
102	82	0	0	0	19		CALCARIA	BNA	0	0	0 FRAG	1991 S
102	83	0	0	0	19		CONGLOME	BNA	0	0	0 FRAG	1991 S
102	84	0	0	0	19		QUARS	BNA	0	0	0 FRAG	1991 S
102	85	0	0	0	19	SE	QUARS	BNA	0	0	0 FRAC	1991 S
102	86	0	0	0	19	SE	QUARS	BNA	0	0	0 FRAC	1991 S
102	87	0	0	0	19	SE	CALCARIA	BNA	0	0	0 FRAC	1991 S
102	88	0	0	0	19	E	RMI	BNA	0	0	0 FRAG	1991 S
102	89	0	0	0	19	W	QUARS	BNA	0	0	0 FRAC	1991 S
102	90	0	0	0	19	W	RMI	BNA	0	0	0 FRAG	1991 S
102	91	0	0	0	19	W	CALCARIA	BNA	0	0	0 FRAC	1991 S
102	92	0	0	0	19	W	RMI	BNA	0	0	0 FRAC	1991 S
102	93	0	0	0	20	W	CALCARIA	BNA	0	0	0 FRAG	1991 S
102	94	0	0	0	20	W	SORRENCA	BNA	0	0	0 FRAG	1991 S
102	95	0	0	0	20	W	RMI	BNA	0	0	0 FRAG	1991 S
102	96	0	0	0	20		RMI	BNA	0	0	0 FRAG	1991 S
102	97	0	0	0	20		SORRENCA	BNA	0	0	0 FRAG	1991 S
102	98	0	0	0	20		RMI	BNA	0	0	0 FRAG	1991 S
102	99	0	0	0	20		RMI	BNA	0	0	0 FRAG	1991 S
102	100	0	0	0	20		QUARS	BPI	0	0	0	1991 S
102	101	0	0	0	20		QUARS	BNA	0	0	0	1991 S
102	102	0	0	0	20		QUARS	BNA	0	0	0 FRAC	1991 S
102	103	0	0	0	20		QUARSITA	BNA	0	0	0 FRAG	1991 S
102	104	0	0	0	20		RMI	BNA	0	0	0	1991 S
102	105	0	0	0	20		RMI	BNA	0	0	0	1991 S
102	106	0	0	0	20		RMI	BNA	0	0	0	1991 S
102	107	0	0	0	20		QUARS	BNA	0	0	0	1991 S
102	108	0	0	0	20		RMI	BNA	0	0	0	1991 S

BOBILA MADURELL  
MAS DURAN  
campanya 1991

E.E. NUM.	X	Y	Zsup	Zinf/ Talla	ORIENT SECTOR	PENDENT MATERIA	OBJECTE	LONG	AMPL	ESPE	ALTERACIONS OBSERVACIONS	P D	
												ANY	U I N B T U
102	109	0	0	0		QUARS	BNA	0	0	0	FRAG	1991	S
102	110	0	0	0		QUARS	BNA	0	0	0	FRAG	1991	S
102	111	0	0	0		ESQUIST	BNA	0	0	0	FRAG	1991	S
102	112	0	0	0		RMI	BNA	0	0	0	FRAG	1991	S
102	113	0	0	0		RMI	BNA	0	0	0	FRAG	1991	S
102	114	0	0	0		RMI	BNA	0	0	0		1991	S
102	115	0	0	0		RMI	BNA	0	0	0	FRAC	1991	S
102	116	0	0	0		SORRENCA	BNA	0	0	0	FRAC	1991	S
102	117	0	0	0		QUARS	BNA	0	0	0	FRAC	1991	S
102	118	0	0	0		CALCARIA	BNA	0	0	0	FRAC	1991	S
102	119	0	0	0		RMI	BNA	0	0	0	FRAG	1991	S
102	120	0	0	0		QUARS	BNA	0	0	0		1991	S
102	121	0	0	0		RMI	BNA	0	0	0	FRAG	1991	S
102	122	0	0	0		OS	INDET	0	0	0		1991	S
102	123	0	0	0	W	OS	INDET	0	0	0		1991	S
102	124	0	0	0	E	OS	DET	0	0	0		1991	S
102	125	0	0	0		OS	INDET	0	0	0		1991	S
102	126	0	0	0	SE	OS	INDET	0	0	0	VARIS FRAGS	1991	S
102	127	0	0	0	SE	OS	DET	0	0	0	DENT	1991	S
102	128	0	0	0	SW	OS	DET	0	0	0		1991	S
102	129	0	0	0	SW	OS	DET	0	0	0	DENT	1991	S
102	130	0	0	0	SW	OS	DET	0	0	0	MD	1991	S
102	131	0	0	0		OS	DET	0	0	0	VARIS FRAGS	1991	S
102	132	0	0	0	SW	OS	DET	0	0	0	FRAG	1991	S
102	133	0	0	0		OS	DET	0	0	0		1991	S
102	134	0	0	0		OS	DET	0	0	0	FRAG	1991	S
102	135	0	0	0	SW	ORGANIC	MOLUSC	0	0	0	PERFORAT	1991	S
102	136	0	0	0		RMI	BNA	0	0	0		1991	S
102	137	0	0	0		SORRENCA	BNA	0	0	0		1991	S
103	1	0	0	0		CERAMICA	INFORME	0	0	0		1991	S
103	2	0	0	0		CERAMICA	INFORME	0	0	0		1991	S
103	3	0	0	0		SILEX	BPF	0	0	0		1991	S
103	4	0	0	0		CERAMICA	INFORME	0	0	0		1991	S
103	5	0	0	0		CERAMICA	INFORME	0	0	0		1991	S
103	6	0	0	0		CERAMICA	INFORME	0	0	0		1991	S
103	7	0	0	0		CERAMICA	INFORME	0	0	0		1991	S
103	8	0	0	0		CERAMICA	INFORME	0	0	0		1991	S
103	9	0	0	0		CERAMICA	INFORME	0	0	0		1991	S
103	10	0	0	0		CERAMICA	INFORME	0	0	0		1991	S
103	11	0	0	0		CERAMICA	INFORME	0	0	0		1991	S
103	12	0	0	0		CERAMICA	INFORME	0	0	0		1991	S
103	13	0	0	0		CERAMICA	APLICA	0	0	0		1991	S
103	14	0	0	0		CERAMICA	INFORME	0	0	0		1991	S
103	15	0	0	0		CERAMICA	INFORME	0	0	0		1991	S
103	16	0	0	0		CERAMICA	INFORME	0	0	0		1991	S
103	17	0	0	0		INDET	BNA	0	0	0		1991	S
103	18	0	0	0	E	CERAMICA	INFORME	0	0	0		1991	S
103	19	0	0	0	E	CERAMICA	INFORME	0	0	0		1991	S
103	20	0	0	0	E	CERAMICA	INFORME	0	0	0		1991	S
103	21	0	0	0	E	CERAMICA	INFORME	0	0	0		1991	S
103	22	0	0	0	E	CERAMICA	INFORME	0	0	0		1991	S

BOBILA MADURELL  
MAS DURAN  
campanya 1991

E.E. NUM.	X	Y	Zsup	Zinf/ Talla	ORIENT	PENDENT SECTOR	MATERIA	OBJECTE	LONG	AMPL	ESPE	ALTERACIONS OBSERVACIONS	P D			
													ANY	U	I	B
													T	U		
103	23	0	0	0	19	E	CERAMICA	INFORME	0	0	0		1991	S		
103	24	0	0	0	19	W	CERAMICA	INFORME	0	0	0		1991	S		
103	25	0	0	0	19	W	CERAMICA	INFORME	0	0	0		1991	S		
103	26	0	0	0	19	W	CERAMICA	INFORME	0	0	0		1991	S		
103	27	0	0	0	19	W	CERAMICA	INFORME	0	0	0		1991	S		
103	28	0	0	0	19	W	CERAMICA	INFORME	0	0	0		1991	S		
103	29	0	0	0	19	W	CERAMICA	INFORME	0	0	0		1991	S		
103	30	0	0	0	19	W	CERAMICA	INFORME	0	0	0		1991	S		
103	31	0	0	0	20	W	CERAMICA	INFORME	0	0	0		1991	S		
103	32	0	0	0	20	W	CERAMICA	INFORME	0	0	0		1991	S		
103	33	0	0	0	20	W	CERAMICA	INFORME	0	0	0		1991	S		
103	34	0	0	0	20	W	CERAMICA	INFORME	0	0	0		1991	S		
103	35	0	0	0	20	W	CERAMICA	INFORME	0	0	0		1991	S		
103	36	0	0	0	20	W	CERAMICA	INFORME	0	0	0		1991	S		
103	37	0	0	0	20	W	CERAMICA	INFORME	0	0	0		1991	S		
103	38	0	0	0	20	W	CERAMICA	INFORME	0	0	0		1991	S		
103	39	0	0	0	20	W	CERAMICA	INFORME	0	0	0		1991	S		
103	40	0	0	0	20	W	CERAMICA	INFORME	0	0	0		1991	S		
103	41	0	0	0	20	W	CERAMICA	INFORME	0	0	0		1991	S		
103	42	0	0	0	20	W	CERAMICA	INFORME	0	0	0		1991	S		
103	43	0	0	0	20	W	CERAMICA	INFORME	0	0	0		1991	S		
103	44	0	0	0	20	W	CERAMICA	INFORME	0	0	0		1991	S		
103	45	0	0	0	20	W	CERAMICA	INFORME	0	0	0		1991	S		
103	46	0	0	0	20	W	CERAMICA	INFORME	0	0	0		1991	S		
103	47	0	0	0	20	W	RMI	BNA	0	0	0	FRAG	1991	S		
103	48	0	0	0	20	W	RMI	BNA	0	0	0	FRAG	1991	S		
103	49	0	0	0	20	E	CERAMICA	VORA	0	0	0		1991	S		
103	50	0	0	0	20	E	CERAMICA	INFORME	0	0	0		1991	S		
103	51	0	0	0	20	E	CERAMICA	INFORME	0	0	0		1991	S		
103	52	0	0	0	20	E	CERAMICA	INFORME	0	0	0		1991	S		
103	53	0	0	0	20	E	CERAMICA	INFORME	0	0	0		1991	S		
103	54	0	0	0	20	W	OS	INDET	0	0	0		1991	S		
103	55	0	0	0	20	W	CALCARIA	BNA	0	0	0		1991	S		
103	56	0	0	0	20	W	RMI	BNA	0	0	0	FRAG	1991	S		
104	1	0	0	0	14		TOVOT	FRAG	0	0	0		1991	S		
104	2	0	0	0	14		TOVOT	FRAG	0	0	0		1991	S		
104	3	0	0	0	14	S	CERAMICA	INFORME	0	0	0	2 FRAGS	1991	S		
104	4	0	0	0	14	S	CERAMICA	INFORME	0	0	0		1991	S		
104	5	0	0	0	14	S	CERAMICA	CARENA	0	0	0		1991	S		
104	6	0	0	0	14	S	CERAMICA	CARENA	0	0	0		1991	S		
104	7	0	0	0	14	S	CERAMICA	CARENA	0	0	0		1991	S		
104	8	0	0	0	14	S	CERAMICA	CARENA	0	0	0		1991	S		
104	9	0	0	0	14	S	CERAMICA	INFORME	0	0	0		1991	S		
104	10	0	0	0	14	S	CERAMICA	INFORME	0	0	0	VARIS FRAGS	1991	S		
104	11	0	0	0	14	S	CERAMICA	INFORME	0	0	0	2 FRAGS	1991	S		
104	12	0	0	0	14	S	CERAMICA	VORA	0	0	0	VARIS FRAGS	1991	S		
104	13	0	0	0	14	S	CERAMICA	INFORME	0	0	0		1991	S		
104	14	0	0	0	14	S	CERAMICA	INFORME	0	0	0		1991	S		
104	15	0	0	0	14	SE	CERAMICA	INFORME	0	0	0		1991	S		
104	16	0	0	0	14	SE	CERAMICA	INFORME	0	0	0	4 FRAGS	1991	S		
104	17	0	0	0	14	SE	CERAMICA	INFORME	0	0	0		1991	S		

BOBILA MADURELL  
MAS DURAN  
campanya 1991

E.E. NUM.	X	Y	Zsup	Zinf/ Talla	ORIENT	PENDENT SECTOR	MATERIA	OBJECTE	LONG	AMPL	ESPE	ALTERACIONS	P D
												OBSERVACIONS	ANY U I N B T U
104	18	0	0	0	14	SE	CERAMICA	INFORME	0	0	0		1991 S
104	19	0	0	0	14	SE	CERAMICA	INFORME	0	0	0	2 FRAGS	1991 S
104	20	0	0	0	14	SW	CERAMICA	INFORME	0	0	0		1991 S
104	21	0	0	0	14	SW	CERAMICA	INFORME	0	0	0		1991 S
104	22	0	0	0	14	SW	CERAMICA	VORA	0	0	0		1991 S
104	23	0	0	0	14	SW	TOVOT	FRAG	0	0	0		1991 S
104	24	0	0	0	14	SW	CERAMICA	INFORME	0	0	0		1991 S
104	25	0	0	0	14	SW	CERAMICA	NANSA	0	0	0		1991 S
104	26	0	0	0	14	SW	CERAMICA	INFORME	0	0	0		1991 S
104	27	0	0	0	14	SW	CERAMICA	INFORME	0	0	0		1991 S
104	28	0	0	0	14	SW	CERAMICA	INFORME	0	0	0		1991 S
104	29	0	0	0	14	SW	CERAMICA	CARENA	0	0	0		1991 S
104	30	0	0	0	14	SW	CERAMICA	INFORME	0	0	0	3 FRAGS	1991 S
104	31	0	0	0	14	SW	CERAMICA	INFORME	0	0	0		1991 S
104	32	0	0	0	14	SW	CERAMICA	NANSA	0	0	0	2 FRAGS	1991 S
104	33	0	0	0	14	SW	TOVOT	FRAG	0	0	0		1991 S
104	34	0	0	0	14	SW	CERAMICA	INFORME	0	0	0		1991 S
104	35	0	0	0	14	SW	CERAMICA	INFORME	0	0	0		1991 S
104	36	0	0	0	14	SW	TOVOT	FRAG	0	0	0		1991 S
104	37	0	0	0	14	SW	CERAMICA	INFORME	0	0	0		1991 S
104	38	0	0	0	14	SW	CERAMICA	INFORME	0	0	0		1991 S
104	39	0	0	0	14	SW	CERAMICA	INFORME	0	0	0		1991 S
104	40	0	0	0	14	SW	CERAMICA	INFORME	0	0	0		1991 S
104	41	0	0	0	14	SW	CERAMICA	INFORME	0	0	0	2 FRAGS	1991 S
104	42	0	0	0	14	SW	CERAMICA	INFORME	0	0	0		1991 S
104	43	0	0	0	14	SW	CERAMICA	INFORME	0	0	0		1991 S
104	44	0	0	0	14	SW	CERAMICA	INFORME	0	0	0		1991 S
104	45	0	0	0	14	SW	CERAMICA	INFORME	0	0	0		1991 S
104	46	0	0	0	14	NW	TOVOT	FRAG	0	0	0		1991 S
104	47	0	0	0	15	SE	CERAMICA	INFORME	0	0	0		1991 S
104	48	0	0	0	15	SE	TOVOT	FRAG	0	0	0		1991 S
104	49	0	0	0	15	SE	TOVOT	FRAG	0	0	0		1991 S
104	50	0	0	0	15	SE	CERAMICA	INFORME	0	0	0		1991 S
104	51	0	0	0	15	SE	CERAMICA	INFORME	0	0	0		1991 S
104	52	0	0	0	15	SE	CERAMICA	INFORME	0	0	0		1991 S
104	53	0	0	0	15	SE	CERAMICA	INFORME	0	0	0		1991 S
104	54	0	0	0	15	SE	TOVOT	FRAG	0	0	0		1991 S
104	55	0	0	0	15	SW	CERAMICA	INFORME	0	0	0		1991 S
104	56	0	0	0	15	SW	TOVOT	FRAG	0	0	0		1991 S
104	57	0	0	0	15	SW	CERAMICA	PANXA	0	0	0		1991 S
104	58	0	0	0	15	SW	CERAMICA	INFORME	0	0	0		1991 S
104	59	0	0	0	15	SW	CERAMICA	INFORME	0	0	0		1991 S
104	60	0	0	0	15	SW	CERAMICA	INFORME	0	0	0		1991 S
104	61	0	0	0	15	SW	CERAMICA	INFORME	0	0	0		1991 S
104	62	0	0	0	15	SW	CERAMICA	INFORME	0	0	0		1991 S
104	63	0	0	0	15	SW	CERAMICA	INFORME	0	0	0		1991 S
104	64	0	0	0	15	SW	CERAMICA	INFORME	0	0	0		1991 S
104	65	0	0	0	15	SW	CERAMICA	INFORME	0	0	0		1991 S
104	66	0	0	0	15	SW	CERAMICA	VORA	0	0	0		1991 S
104	67	0	0	0	15	SW	CERAMICA	INFORME	0	0	0		1991 S
104	68	0	0	0	15	SW	CERAMICA	VORA	0	0	0		1991 S

BOBILA MADURELL  
MAS DURAN  
campanya 1991

E.E. NUM.	X	Y	Zsup	Zinf/	ORIENT	PENDENT	MATERIA	OBJECTE	LONG	AMPL	ESPE	ALTERACIONS	P	D
												OBSERVACIONS	ANY	U
													N	B
													T	U
					Talla	SECTOR								
104	69	0	0	0	15	SW	CERAMICA	VORA	0	0	0		1991	S
104	70	0	0	0	15	SW	TOVOT	FRAG	0	0	0		1991	S
104	71	0	0	0	15	SW	CERAMICA	INFORME	0	0	0		1991	S
104	72	0	0	0	15	SW	CERAMICA	INFORME	0	0	0		1991	S
104	73	0	0	0	15	SW	CERAMICA	VORA	0	0	0		1991	S
104	74	0	0	0	15	SW	CERAMICA	PANXA	0	0	0		1991	S
104	75	0	0	0	15	SW	CERAMICA	INFORME	0	0	0	DECORADA	1991	S
104	76	0	0	0	15	N	CERAMICA	INFORME	0	0	0	3 FRAGS	1991	S
104	77	0	0	0	15	N	CERAMICA	INFORME	0	0	0		1991	S
104	78	0	0	0	15	NE	CERAMICA	VORA	0	0	0		1991	S
104	79	0	0	0	15	NW	CERAMICA	INFORME	0	0	0		1991	S
104	80	0	0	0	15	NW	CERAMICA	INFORME	0	0	0		1991	S
104	81	0	0	0	15	NW	CERAMICA	INFORME	0	0	0		1991	S
104	82	0	0	0	15	NW	CERAMICA	VORA	0	0	0		1991	S
104	83	0	0	0	15		CERAMICA	INFORME	0	0	0		1991	S
104	84	0	0	0	15		CERAMICA	INFORME	0	0	0		1991	S
104	85	0	0	0	16	SE	CERAMICA	APLICA	0	0	0	LLENGETA	1991	S
104	86	0	0	0	16	SE	CERAMICA	APLICA	0	0	0	MUGRO	1991	S
104	87	0	0	0	16	SE	CERAMICA	INFORME	0	0	0		1991	S
104	88	0	0	0	16	SE	CERAMICA	VORA	0	0	0		1991	S
104	89	0	0	0	16	SE	CERAMICA	INFORME	0	0	0		1991	S
104	90	0	0	0	16	SE	CERAMICA	INFORME	0	0	0		1991	S
104	91	0	0	0	16	SE	CERAMICA	INFORME	0	0	0	2 FRAGS	1991	S
104	92	0	0	0	16	SE	CERAMICA	INFORME	0	0	0	2 FRAGS	1991	S
104	93	0	0	0	16	SE	CERAMICA	INFORME	0	0	0		1991	S
104	94	0	0	0	16	SW	CERAMICA	INFORME	0	0	0		1991	S
104	95	0	0	0	16	SW	CERAMICA	INFORME	0	0	0		1991	S
104	96	0	0	0	16	SW	CERAMICA	INFORME	0	0	0		1991	S
104	97	0	0	0	16	SW	CERAMICA	INFORME	0	0	0		1991	S
104	98	0	0	0	16	SW	CERAMICA	PANXA	0	0	0		1991	S
104	99	0	0	0	16	N	CERAMICA	INFORME	0	0	0		1991	S
104	100	0	0	0	16	N	CERAMICA	HANSA	0	0	0		1991	S
104	101	0	0	0	16	N	CERAMICA	INFORME	0	0	0		1991	S
104	102	0	0	0	16	N	CERAMICA	VORA	0	0	0		1991	S
104	103	0	0	0	16	N	CERAMICA	INFORME	0	0	0		1991	S
104	104	0	0	0	16	N	CERAMICA	INFORME	0	0	0	2 FRAGS	1991	S
104	105	0	0	0	16	N	CERAMICA	INFORME	0	0	0		1991	S
104	106	0	0	0	16	N	CERAMICA	PANXA	0	0	0		1991	S
104	107	0	0	0	16	N	CERAMICA	PANXA	0	0	0		1991	S
104	108	0	0	0	16	N	CERAMICA	PANXA	0	0	0		1991	S
104	109	0	0	0	16	N	CERAMICA	PANXA	0	0	0		1991	S
104	110	0	0	0	16	N	CERAMICA	VORA	0	0	0		1991	S
104	111	0	0	0	16	N	TOVOT	FRAG	0	0	0		1991	S
104	112	0	0	0	16	N	CERAMICA	INFORME	0	0	0	2 FRAGS	1991	S
104	113	0	0	0	16	N	CERAMICA	INFORME	0	0	0		1991	S
104	114	0	0	0	16	N	CERAMICA	PANXA	0	0	0		1991	S
104	115	0	0	0	16	N	CERAMICA	PANXA	0	0	0		1991	S
104	116	0	0	0	16	N	CERAMICA	PANXA	0	0	0		1991	S
104	117	0	0	0	16	N	CERAMICA	PANXA	0	0	0		1991	S
104	118	0	0	0	16	N	CERAMICA	INFORME	0	0	0		1991	S
104	119	0	0	0	16	N	CERAMICA	INFORME	0	0	0		1991	S

BOBILA MADURELL  
MAS DURAN  
campanya 1991

E.E. NUM.	X	Y	Zsup	Zinf/ Talla	ORIENT	PENDENT SECTOR	MATERIA	OBJECTE	LONG	AMPL	ESPE	ALTERACIONS	P D
												OBSERVACIONS	ANY U I N B T U
104	120	0	0	0	16	N	CERAMICA	PANXA	0	0	0		1991 S
104	121	0	0	0	16	N	CERAMICA	VORA	0	0	0		1991 S
104	122	0	0	0	16	N	CERAMICA	INFORME	0	0	0		1991 S
104	123	0	0	0	16	N	CERAMICA	INFORME	0	0	0		1991 S
104	124	0	0	0	16	N	CERAMICA	INFORME	0	0	0		1991 S
104	125	0	0	0	16	N	CERAMICA	INFORME	0	0	0		1991 S
104	126	0	0	0	16	N	TOVOT	FRAG	0	0	0		1991 S
104	127	0	0	0	16	N	TOVOT	FRAG	0	0	0		1991 S
104	128	0	0	0	16	N	CERAMICA	INFORME	0	0	0	2 FRAGS	1991 S
104	129	0	0	0	16	N	CERAMICA	INFORME	0	0	0		1991 S
104	130	0	0	0	16	N	TOVOT	FRAG	0	0	0		1991 S
104	131	0	0	0	16	N	CERAMICA	NANSA	0	0	0		1991 S
104	132	0	0	0	16	N	TOVOT	FRAG	0	0	0		1991 S
104	133	0	0	0	16	NE	CERAMICA	INFORME	0	0	0		1991 S
104	134	0	0	0	16	NW	CERAMICA	INFORME	0	0	0		1991 S
104	135	0	0	0	16	NE	CERAMICA	INFORME	0	0	0		1991 S
104	136	0	0	0	16	NE	CERAMICA	INFORME	0	0	0		1991 S
104	137	0	0	0	16	NE	CERAMICA	INFORME	0	0	0		1991 S
104	138	0	0	0	16	NW	CERAMICA	VORA	0	0	0		1991 S
104	139	0	0	0	16	NW	CERAMICA	PANXA	0	0	0		1991 S
104	140	0	0	0	16	NW	CERAMICA	PANXA	0	0	0		1991 S
104	141	0	0	0	16	NW	CERAMICA	INFORME	0	0	0	3 FRAGS	1991 S
104	142	0	0	0	17		CERAMICA	INFORME	0	0	0		1991 S
104	143	0	0	0	17		CERAMICA	PANXA	0	0	0		1991 S
104	144	0	0	0	17		CERAMICA	PANXA	0	0	0		1991 S
104	145	0	0	0	17	N	CERAMICA	INFORME	0	0	0		1991 S
104	146	0	0	0	17	N	CERAMICA	NANSA	0	0	0	FRAG	1991 S
104	147	0	0	0	17	N	CERAMICA	INFORME	0	0	0		1991 S
104	148	0	0	0	17	N	CERAMICA	PANXA	0	0	0	2 FRAGS	1991 S
104	149	0	0	0	17	N	CERAMICA	INFORME	0	0	0		1991 S
104	150	0	0	0	17	N	CERAMICA	VORA	0	0	0		1991 S
104	151	0	0	0	17	N	CERAMICA	INFORME	0	0	0		1991 S
104	152	0	0	0	17	N	CERAMICA	INFORME	0	0	0		1991 S
104	153	0	0	0	17	N	CERAMICA	APLICA	0	0	0	LLENGETA	1991 S
104	154	0	0	0	17	N	CERAMICA	VORA	0	0	0	VARIS FRAGS	1991 S
104	155	0	0	0	17	N	TOVOT	FRAG	0	0	0		1991 S
104	156	0	0	0	17	N	CERAMICA	INFORME	0	0	0	VARIS FRAGS	1991 S
104	157	0	0	0	17	NW	CERAMICA	VORA	0	0	0	LLENGETA 3FRAG	1991 S
104	158	0	0	0	17	NW	CERAMICA	INFORME	0	0	0	2 FRAGS	1991 S
104	159	0	0	0	17	NW	CERAMICA	INFORME	0	0	0		1991 S
104	160	0	0	0	17	NW	CERAMICA	INFORME	0	0	0		1991 S
104	161	0	0	0	17	NE	CERAMICA	PANXA	0	0	0		1991 S
104	162	0	0	0	17	NE	CERAMICA	CARENA	0	0	0		1991 S
104	163	0	0	0	17	NE	CERAMICA	VORA	0	0	0		1991 S
104	164	0	0	0	17	SE	CERAMICA	INFORME	0	0	0	2 FRAGS	1991 S
104	165	0	0	0	17	SE	CERAMICA	INFORME	0	0	0		1991 S
104	166	0	0	0	17	SE	CERAMICA	PANXA	0	0	0		1991 S
104	167	0	0	0	17	SE	CERAMICA	INFORME	0	0	0		1991 S
104	168	0	0	0	17	SE	CERAMICA	VORA	0	0	0	NANSA	1991 S
104	169	0	0	0	17	SE	CERAMICA	VORA	0	0	0		1991 S
104	170	0	0	0	17	SW	CERAMICA	INFORME	0	0	0	2 FRAGS	1991 S

BOBILA MADURELL  
MAS DURAN  
campanya 1991

E.E. NUM.	X	Y	Zsup	Zinf/ Talla	ORIENT	PENDENT SECTOR	MATERIA	OBJECTE	LONG	AMPL	ESPE	ALTERACIONS	P D
												OBSERVACIONS	
104	171	0	0	0	17	SW	CERAMICA	VORA	0	0	0		1991 S
104	172	0	0	0	17	SW	CERAMICA	PANXA	0	0	0		1991 S
104	173	0	0	0	17	SW	CERAMICA	VORA	0	0	0		1991 S
104	174	0	0	0	17	SW	CERAMICA	INFORME	0	0	0		1991 S
104	175	0	0	0	17	SW	CERAMICA	INFORME	0	0	0		1991 S
104	176	0	0	0	17	SW	CERAMICA	INFORME	0	0	0		1991 S
104	177	0	0	0	17	SW	CERAMICA	PANXA	0	0	0		1991 S
104	178	0	0	0	17	SW	CERAMICA	APLICA	0	0	0	LLENGETA	1991 S
104	179	0	0	0	17	SW	CERAMICA	INFORME	0	0	0		1991 S
104	180	0	0	0	17	SW	CERAMICA	PANXA	0	0	0		1991 S
104	181	0	0	0	17	SW	CERAMICA	PANXA	0	0	0		1991 S
104	182	0	0	0	17	SW	CERAMICA	VORA	0	0	0	2 FRAGS	1991 S
104	183	0	0	0	18	SW	CERAMICA	INFORME	0	0	0		1991 S
104	184	0	0	0	18	SW	CERAMICA	INFORME	0	0	0		1991 S
104	185	0	0	0	18	SW	CERAMICA	PANXA	0	0	0		1991 S
104	186	0	0	0	18	SW	CERAMICA	INFORME	0	0	0	VARIS FRAGS	1991 S
104	187	0	0	0	18	N	CERAMICA	INFORME	0	0	0		1991 S
104	188	0	0	0	18	N	CERAMICA	INFORME	0	0	0	VARIS FRAGS	1991 S
104	189	0	0	0	18	NE	CERAMICA	VORA	0	0	0		1991 S
104	190	0	0	0	16	NE	CERAMICA	NANSA	0	0	0		1991 S
104	191	0	0	0	18	NE	CERAMICA	INFORME	0	0	0		1991 S
104	192	0	0	0	18	NE	CERAMICA	APLICA	0	0	0		1991 S
104	193	0	0	0	18	NE	CERAMICA	INFORME	0	0	0		1991 S
104	194	0	0	0	18	NE	CERAMICA	VORA	0	0	0		1991 S
104	195	0	0	0	18	NE	CERAMICA	INFORME	0	0	0		1991 S
104	196	0	0	0	14	SE	SILEX	BPF	0	0	0		1991 S
104	197	0	0	0	14	SW	QUARS	BPF	0	0	0		1991 S
104	198	0	0	0	14	SW	QUARS	BPI	0	0	0		1991 S
104	199	0	0	0	15	SE	SILEX	BPF	0	0	0		1991 S
104	200	0	0	0	15	SE	SILEX	BPF	0	0	0		1991 S
104	201	0	0	0	15	SE	QUARS	BPI	0	0	0		1991 S
104	202	0	0	0	15	SE	QUARS	BP2G	0	0	0		1991 S
104	203	0	0	0	15	SW	SILEX	BP2G	0	0	0		1991 S
104	204	0	0	0	15	SW	SILEX	BPF	0	0	0		1991 S
104	205	0	0	0	16	N	SILEX	BP	0	0	0		1991 S
104	206	0	0	0	17	N	INDET	BNE	0	0	0		1991 S
104	207	0	0	0	15	SE	QUARS	BP2G	0	0	0		1991 S
104	208	0	0	0	14		QUARS	BN1G	0	0	0		1991 S
104	209	0	0	0	14		SILEX	BN1G	0	0	0		1991 S
104	210	0	0	0	15	SE	SILEX	BN1G	0	0	0		1991 S
104	211	0	0	0	15	SE	INDET	BNE	0	0	0		1991 S
104	212	0	0	0	14		TOVOT	FRAG	0	0	0		1991 S
104	213	0	0	0	14		QUARS	BNA	0	0	0	FRAG	1991 S
104	214	0	0	0	14		QUARS	BNA	0	0	0	FRAG	1991 S
104	215	0	0	0	14		CALCARIA	BNA	0	0	0	FRAG	1991 S
104	216	0	0	0	14		RMI	BNA	0	0	0	FRAG	1991 S
104	217	0	0	0	14		QUARS	BNA	0	0	0		1991 S
104	218	0	0	0	14	SW	TOVOT	FRAG	0	0	0		1991 S
104	219	0	0	0	14		CALCARIA	BNA	0	0	0		1991 S
104	220	0	0	0	14		RMI	BNA	0	0	0	2 FRAGS	1991 S
104	221	0	0	0	14		SORRENCA	BNA	0	0	0		1991 S

173



BOBILA MADURELL  
MAS DURAN  
campanya 1991

E.E. NUM.	X	Y	Zsup	Zinf/ Talla	ORIENT	PENDENT SECTOR	MATERIA	OBJECTE	LONG	AMPL	ESPE	ALTERACIONS	P D	
												OBSERVACIONS		ANY
104	222	0	0	0	14		CALCARIA	BNA	0	0	0	ALTERAT	1991	S
104	223	0	0	0	14		QUARS	BNA	0	0	0	FRAG	1991	S
104	224	0	0	0	14		CALCARIA	BNA	0	0	0		1991	S
104	225	0	0	0	14		ESQUIST	BNA	0	0	0	FRAG	1991	S
104	226	0	0	0	14		QUARS	BNA	0	0	0	FRAG	1991	S
104	227	0	0	0	14		RMI	BNA	0	0	0	FRAG	1991	S
104	228	0	0	0	14		SORRENCA	BNA	0	0	0		1991	S
104	229	0	0	0	14		SORRENCA	BNA	0	0	0		1991	S
104	230	0	0	0	14	SE	ESQUIST	BNA	0	0	0		1991	S
104	231	0	0	0	14	SE	RMI	BNA	0	0	0		1991	S
104	232	0	0	0	14		RMI	BNA	0	0	0	FRAG	1991	S
104	233	0	0	0	14		RMI	BNA	0	0	0	FRAG	1991	S
104	234	0	0	0	14		SORRENCA	BNA	0	0	0	FRAG	1991	S
104	235	0	0	0	14		SORRENCA	BNA	0	0	0	2 FRAGS	1991	S
104	236	0	0	0	14		QUARS	BNA	0	0	0	FRAG	1991	S
104	237	0	0	0	14		RMI	BNA	0	0	0	FRAG	1991	S
104	238	0	0	0	14		RMI	BNA	0	0	0	FRAG	1991	S
104	239	0	0	0	14		CALCARIA	BNA	0	0	0		1991	S
104	240	0	0	0	15		CONGLOME	BNA	0	0	0	FRAG	1991	S
104	241	0	0	0	15		RMI	BNA	0	0	0		1991	S
104	242	0	0	0	15		QUARS	BNA	0	0	0	FRAC	1991	S
104	243	0	0	0	15		SORRENCA	BNA	0	0	0		1991	S
104	244	0	0	0	15		RMI	BNA	0	0	0	FRAG	1991	S
104	245	0	0	0	15		CALCARIA	BNA	0	0	0	FRAC	1991	S
104	246	0	0	0	15		CONGLOME	BNA	0	0	0		1991	S
104	247	0	0	0	15		CONGLOME	BNA	0	0	0	FRAG	1991	S
104	248	0	0	0	15		CONGLOME	BNA	0	0	0	FRAG	1991	S
104	249	0	0	0	15		SORRENCA	BNA	0	0	0		1991	S
104	250	0	0	0	15	SE	TOVOT	FRAG	0	0	0		1991	S
104	251	0	0	0	15	SE	RMI	BNA	0	0	0		1991	S
104	252	0	0	0	15	SE	SORRENCA	BNA	0	0	0	FRAG	1991	S
104	253	0	0	0	15	SE	QUARS	BNA	0	0	0		1991	S
104	254	0	0	0	15	SE	SORRENCA	BNA	0	0	0	FRAG	1991	S
104	255	0	0	0	15	SE	SORRENCA	BNA	0	0	0	FRAC	1991	S
104	256	0	0	0	15	SE	RMI	BNA	0	0	0	FRAG	1991	S
104	257	0	0	0	15	SE	SORRENCA	BNA	0	0	0	FRAG	1991	S
104	258	0	0	0	15	SE	SORRENCA	BNA	0	0	0	FRAG	1991	S
104	259	0	0	0	15	SE	RMI	BNA	0	0	0	FRAG	1991	S
104	260	0	0	0	15	SE	GRANIT	BNA	0	0	0	FRAG	1991	S
104	261	0	0	0	15	SE	CALCARIA	BNA	0	0	0	FRAG	1991	S
104	262	0	0	0	15	SE	SORRENCA	BNA	0	0	0	FRAG	1991	S
104	263	0	0	0	15	SE	CALCARIA	BNA	0	0	0		1991	S
104	264	0	0	0	15	NW	QUARS	BNA	0	0	0	FRAG	1991	S
104	265	0	0	0	15	NW	QUARS	BN1G	0	0	0		1991	S
104	266	0	0	0	15	NW	RMI	BNA	0	0	0	FRAG	1991	S
104	267	0	0	0	15	NW	RMI	BNA	0	0	0	FRAG	1991	S
104	268	0	0	0	15	NW	CALCARIA	BNA	0	0	0	FRAG	1991	S
104	269	0	0	0	15	NW	SORRENCA	BNA	0	0	0	FRAG	1991	S
104	270	0	0	0	15	NW	CONGLOME	BNA	0	0	0		1991	S
104	271	0	0	0	15	NW	RMI	BNA	0	0	0	FRAG	1991	S
104	272	0	0	0	15	N	QUARS	BNA	0	0	0	FRAG	1991	S

BOBILA MADURELL  
MAS DURAN  
campanya 1991

E.E. NUM.	X	Y	Zsup	Zinf/ Talla	ORIENT	PENDENT SECTOR	MATERIA	OBJECTE	LONG	AMPL	ESPE	ALTERACIONS	P D
												OBSERVACIONS	
104	273	0	0	0	15	N	RMI	BNA	0	0	0	FRAG	1991 S
104	274	0	0	0	15	N	SORRENCA	BNA	0	0	0	FRAG	1991 S
104	275	0	0	0	15	N	INDET	BNA	0	0	0	FRAG	1991 S
104	276	0	0	0	15	N	RMI	BNA	0	0	0	FRAG	1991 S
104	277	0	0	0	15	N	QUARS	BNA	0	0	0	FRAG	1991 S
104	278	0	0	0	15	SW	RMI	BNA	0	0	0	FRAG	1991 S
104	279	0	0	0	15	SW	RMI	BNA	0	0	0	FRAG	1991 S
104	280	0	0	0	15	SW	SORRENCA	BNA	0	0	0		1991 S
104	281	0	0	0	15	SW	ESQUIST	BNA	0	0	0	FRAG	1991 S
104	282	0	0	0	15	SW	CALCARIA	BNA	0	0	0		1991 S
104	283	0	0	0	16	N	SORRENCA	BNA	0	0	0	FRAG	1991 S
104	284	0	0	0	16	N	RMI	BNA	0	0	0		1991 S
104	285	0	0	0	16	N	RMI	BNA	0	0	0	FRAG	1991 S
104	286	0	0	0	16	N	CALCARIA	BNA	0	0	0	FRAG	1991 S
104	287	0	0	0	16	N	QUARS	BNA	0	0	0	FRAG	1991 S
104	288	0	0	0	16	N	CALCARIA	BNA	0	0	0	FRAC	1991 S
104	289	0	0	0	16	N	CONGLOME	BNA	0	0	0		1991 S
104	290	0	0	0	16	N	RMI	BNA	0	0	0	FRAG	1991 S
104	291	0	0	0	16	N	RMI	BNA	0	0	0	FRAG	1991 S
104	292	0	0	0	16		CONGLOME	BNA	0	0	0	FRAG	1991 S
104	293	0	0	0	16	SE	RMI	BNA	0	0	0	FRAG	1991 S
104	294	0	0	0	16	SE	RMI	BNA	0	0	0		1991 S
104	295	0	0	0	16	SE	SORRENCA	BNA	0	0	0	FRAG	1991 S
104	296	0	0	0	16	SE	CONGLOME	BNA	0	0	0		1991 S
104	297	0	0	0	16	SE	CONGLOME	BNA	0	0	0	FRAG	1991 S
104	298	0	0	0	16	SE	QUARS	BNA	0	0	0	FRAG	1991 S
104	299	0	0	0	16	SE	QUARS	BNA	0	0	0	FRAG	1991 S
104	300	0	0	0	16	SE	CALCARIA	BNA	0	0	0		1991 S
104	301	0	0	0	16	SE	RMI	BNA	0	0	0		1991 S
104	302	0	0	0	16	SE	RMI	BNA	0	0	0	FRAG	1991 S
104	303	0	0	0	16	SE	RMI	BNA	0	0	0	FRAG	1991 S
104	304	0	0	0	16	NE	CALCARIA	BNA	0	0	0		1991 S
104	305	0	0	0	16	NE	RMI	BNA	0	0	0		1991 S
104	306	0	0	0	16	NE	RMI	BNA	0	0	0	FRAG	1991 S
104	307	0	0	0	16	NE	RMI	BNA	0	0	0	FRAG	1991 S
104	308	0	0	0	16	NE	RMI	BNA	0	0	0	FRAG	1991 S
104	309	0	0	0	16	NE	CALCARIA	BNA	0	0	0		1991 S
104	310	0	0	0	16	NW	SORRENCA	BNA	0	0	0	FRAG	1991 S
104	311	0	0	0	16	NW	RMI	BNA	0	0	0	FRAG	1991 S
104	312	0	0	0	16	NW	SORRENCA	BNA	0	0	0	FRAG	1991 S
104	313	0	0	0	16	NW	RMI	BNA	0	0	0		1991 S
104	314	0	0	0	16	NW	RMI	BNA	0	0	0	FRAG	1991 S
104	315	0	0	0	16	NW	RMI	BNA	0	0	0	FRAG	1991 S
104	316	0	0	0	16	NW	SORRENCA	BNA	0	0	0	FRAG	1991 S
104	317	0	0	0	16	NW	GRANIT	BNA	0	0	0		1991 S
104	318	0	0	0	16	NW	RMI	BNA	0	0	0	FRAG	1991 S
104	319	0	0	0	16	NW	SORRENCA	BNA	0	0	0	FRAG	1991 S
104	320	0	0	0	16	NW	RMI	BNA	0	0	0	FRAG	1991 S
104	321	0	0	0	16	NW	SILEX	BN1G	0	0	0		1991 S
104	322	0	0	0	16	NW	QUARS	BNA	0	0	0		1991 S
104	323	0	0	0	16	NW	CALCARIA	BNA	0	0	0		1991 S

175

BOBILA MADURELL  
MAS DURAN  
campanya 1991

E.E. NUM.	X	Y	Zsup	Zinf/	ORIENT	PENDENT	MATERIA	OBJECTE	LONG	AMPL	ESPE	ALTERACIONS OBSERVACIONS	P D	ANY U I				
														Talla	SECTOR	N	B	T
104	324	0	0	0	16	NW	QUARS	BNA	0	0	0		1991	S				
104	325	0	0	0	16	NW	CALCARIA	BNA	0	0	0	FRAG CREMAT	1991	S				
104	326	0	0	0	16	NW	QUARS	BNA	0	0	0	FRAG	1991	S				
104	327	0	0	0	16	NW	CALCARIA	BNA	0	0	0	FRAG	1991	S				
104	328	0	0	0	16	NW	RMI	BNA	0	0	0	FRAC	1991	S				
104	329	0	0	0	16	SW	QUARS	BNA	0	0	0	FRAG	1991	S				
104	330	0	0	0	16	NW	RMI	BNA	0	0	0		1991	S				
104	331	0	0	0	16	NW	QUARS	BNA	0	0	0	FRAG	1991	S				
104	332	0	0	0	16	NW	RMI	BNA	0	0	0		1991	S				
104	333	0	0	0	16	NW	RMI	BNA	0	0	0		1991	S				
104	334	0	0	0	16	NW	SORRENCA	BNA	0	0	0	FRAG	1991	S				
104	335	0	0	0	16	NW	RMI	BNA	0	0	0	FRAC	1991	S				
104	336	0	0	0	16	NW	RMI	BNA	0	0	0		1991	S				
104	337	0	0	0	16	NW	RMI	BNA	0	0	0	FRAC	1991	S				
104	338	0	0	0	16	SW	RMI	BNA	0	0	0	FRAG	1991	S				
104	339	0	0	0	16	SW	RMI	BNA	0	0	0	FRAG	1991	S				
104	340	0	0	0	16	SW	SORRENCA	BNA	0	0	0		1991	S				
104	341	0	0	0	16	SW	RMI	BNA	0	0	0		1991	S				
104	342	0	0	0	16	SW	RMI	BNA	0	0	0	FRAG	1991	S				
104	343	0	0	0	16	SW	RMI	BNA	0	0	0	FRAG	1991	S				
104	344	0	0	0	16	SW	QUARS	BNA	0	0	0	FRAG	1991	S				
104	345	0	0	0	16	SW	CALCARIA	BNA	0	0	0		1991	S				
104	346	0	0	0	16	SW	QUARS	BNA	0	0	0		1991	S				
104	347	0	0	0	16	SW	RMI	BNA	0	0	0	FRAG	1991	S				
104	348	0	0	0	17	NE	CONGLOME	BNA	0	0	0	FRAG	1991	S				
104	349	0	0	0	17	NE	QUARS	BNA	0	0	0	FRAG	1991	S				
104	350	0	0	0	17	NE	SORRENCA	BNA	0	0	0	FRAG	1991	S				
104	351	0	0	0	17	NE	SORRENCA	BNA	0	0	0	FRAG	1991	S				
104	352	0	0	0	17	NE	CONGLOME	BNA	0	0	0	FRAG	1991	S				
104	353	0	0	0	17	NE	RMI	BNA	0	0	0	FRAG	1991	S				
104	354	0	0	0	17	NE	SORRENCA	BNA	0	0	0	FRAG	1991	S				
104	355	0	0	0	17	NE	SORRENCA	BNA	0	0	0	FRAG CREMAT	1991	S				
104	356	0	0	0	17	NE	QUARS	BNA	0	0	0	FRAC	1991	S				
104	357	0	0	0	17	NE	QUARS	BNA	0	0	0		1991	S				
104	358	0	0	0	17	NE	CALCARIA	BNA	0	0	0		1991	S				
104	359	0	0	0	17	NE	SORRENCA	BNA	0	0	0	FRAG	1991	S				
104	360	0	0	0	17	NE	SORRENCA	BNA	0	0	0		1991	S				
104	361	0	0	0	17	N	RMI	BNA	0	0	0	FRAG	1991	S				
104	362	0	0	0	17	SW	RMI	BNA	0	0	0	FRAG	1991	S				
104	363	0	0	0	17	NW	SORRENCA	BNA	0	0	0	FRAC	1991	S				
104	364	0	0	0	17	NW	QUARS	BNA	0	0	0	FRAG	1991	S				
104	365	0	0	0	17	NW	RMI	BNA	0	0	0	FRAG	1991	S				
104	366	0	0	0	17	NW	RMI	BNE	0	0	0		1991	S				
104	367	0	0	0	17	NW	RMI	BNA	0	0	0	FRAG	1991	S				
104	368	0	0	0	17	NW	SORRENCA	BNA	0	0	0	FRAG	1991	S				
104	369	0	0	0	17	NW	RMI	BNA	0	0	0	FRAG	1991	S				
104	370	0	0	0	17	NW	SORRENCA	BNA	0	0	0		1991	S				
104	371	0	0	0	17	NW	SORRENCA	BNA	0	0	0		1991	S				
104	372	0	0	0	17	NW	RMI	BNA	0	0	0	FRAG	1991	S				
104	373	0	0	0	17	NW	CALCARIA	BNA	0	0	0		1991	S				
104	374	0	0	0	17	NW	SORRENCA	BNA	0	0	0	FRAG	1991	S				

BOBILA MADURELL  
MAS DURAN  
campanya 1991

E.E. NUM.	X	Y	Zsup	Zinf/ Talla	ORIENT	PENDENT SECTOR	MATERIA	OBJECTE	LONG	AMPL	ESPE	ALTERACIONS	P D
												OBSERVACIONS	
104	375	0	0	0	17	NW	RMI	BNA	0	0	0	FRAG	1991 S
104	376	0	0	0	17	NW	QUARS	BNA	0	0	0	FRAC	1991 S
104	377	0	0	0	17	NW	RMI	BNA	0	0	0		1991 S
104	378	0	0	0	17	SE	SORRENCA	BNA	0	0	0	FRAG	1991 S
104	379	0	0	0	17	SE	RMI	BNA	0	0	0	FRAG	1991 S
104	380	0	0	0	17	SE	QUARS	BNA	0	0	0	FRAC	1991 S
104	381	0	0	0	17	SE	SORRENCA	BNA	0	0	0	FRAG	1991 S
104	382	0	0	0	17	SE	RMI	BNA	0	0	0	FRAC	1991 S
104	383	0	0	0	17	SE	CALCARIA	BNA	0	0	0	FRAC	1991 S
104	384	0	0	0	17	SE	RMI	BNA	0	0	0		1991 S
104	385	0	0	0	17	SE	ESQUIST	BNA	0	0	0	FRAG	1991 S
104	386	0	0	0	17	SE	RMI	BNA	0	0	0		1991 S
104	387	0	0	0	17	SE	RMI	BNA	0	0	0		1991 S
104	388	0	0	0	17	SE	RMI	BNA	0	0	0	FRAG	1991 S
104	389	0	0	0	17	SE	RMI	BNA	0	0	0		1991 S
104	390	0	0	0	17	SE	SORRENCA	BNA	0	0	0		1991 S
104	391	0	0	0	17	SE	QUARS	BNA	0	0	0	FRAG	1991 S
104	392	0	0	0	17	SE	QUARS	BNA	0	0	0	FRAG	1991 S
104	393	0	0	0	17	SE	SORRENCA	BNA	0	0	0	FRAG	1991 S
104	394	0	0	0	17	SE	SORRENCA	BNA	0	0	0		1991 S
104	395	0	0	0	17	SE	SORRENCA	BNA	0	0	0	FRAG	1991 S
104	396	0	0	0	17	SE	RMI	BNA	0	0	0	FRAG	1991 S
104	397	0	0	0	17	SE	ESQUIST	BNA	0	0	0	FRAG	1991 S
104	398	0	0	0	17	SE	RMI	BNA	0	0	0	FRAG	1991 S
104	399	0	0	0	17	SE	QUARS	BNA	0	0	0	FRAC	1991 S
104	400	0	0	0	17	SE	QUARS	BNA	0	0	0	FRAG	1991 S
104	401	0	0	0	17	SE	QUARS	BNA	0	0	0	FRAG	1991 S
104	402	0	0	0	17	SE	CALCARIA	BNA	0	0	0		1991 S
104	403	0	0	0	17	SE	RMI	BNA	0	0	0	FRAG	1991 S
104	404	0	0	0	17	SE	SORRENCA	BNA	0	0	0	FRAG	1991 S
104	405	0	0	0	17	SE	RMI	BNA	0	0	0	FRAG	1991 S
104	406	0	0	0	17	SE	QUARS	BNA	0	0	0		1991 S
104	407	0	0	0	17	SE	QUARS	BNA	0	0	0		1991 S
104	408	0	0	0	17	SE	SORRENCA	BNA	0	0	0	FRAG	1991 S
104	409	0	0	0	17	SE	RMI	BNA	0	0	0	FRAG	1991 S
104	410	0	0	0	17	SE	SORRENCA	BNA	0	0	0		1991 S
104	411	0	0	0	17	SE	SORRENCA	BNA	0	0	0		1991 S
104	412	0	0	0	17	SE	SORRENCA	BNA	0	0	0	FRAC	1991 S
104	413	0	0	0	17	SE	RMI	BNA	0	0	0	FRAG CREMAT	1991 S
104	414	0	0	0	17	SE	CALCARIA	BNA	0	0	0		1991 S
104	415	0	0	0	17	SE	CALCARIA	BNA	0	0	0	FRAG	1991 S
104	416	0	0	0	17	SE	SORRENCA	BNA	0	0	0	FRAG	1991 S
104	417	0	0	0	17	SE	RMI	BNA	0	0	0		1991 S
104	418	0	0	0	17	SE	CALCARIA	BNA	0	0	0		1991 S
104	419	0	0	0	17		SORRENCA	BNA	0	0	0	FRAG	1991 S
104	420	0	0	0	17	SW	RMI	BNA	0	0	0	FRAC	1991 S
104	421	0	0	0	17	SW	QUARS	BNA	0	0	0	FRAG	1991 S
104	422	0	0	0	17	SW	RMI	BNA	0	0	0	FRAG	1991 S
104	423	0	0	0	17	SW	RMI	BNA	0	0	0	FRAG	1991 S
104	424	0	0	0	17	SW	RMI	BNA	0	0	0	FRAG	1991 S
104	425	0	0	0	17	SW	RMI	BNA	0	0	0	FRAG	1991 S

177

BOBILA MADURELL  
MAS DURAN  
campanya 1991

E.E. NUM.	X	Y	Zsup	Zinf/ Talla	ORIENT	PENDENT SECTOR	MATERIA	OBJECTE	LONG	AMPL	ESPE	ALTERACIONS	P D
												OBSERVACIONS	ANY U I N B T U
104	426	0	0	0	17	SW	ESQUIST	BNA	0	0	0	FRAG	1991 S
104	427	0	0	0	17	SW	RMI	BNA	0	0	0	FRAG	1991 S
104	428	0	0	0	17	SW	RMI	BNA	0	0	0	FRAG	1991 S
104	429	0	0	0	17	SW	CONGLOME	BNA	0	0	0	FRAG	1991 S
104	430	0	0	0	17	SW	QUARS	BNA	0	0	0	FRAG	1991 S
104	431	0	0	0	17	SW	QUARS	BNA	0	0	0	FRAG	1991 S
104	432	0	0	0	17	SW	RMI	BNA	0	0	0	FRAG	1991 S
104	433	0	0	0	17	SW	RMI	BNA	0	0	0	FRAG	1991 S
104	434	0	0	0	17	SW	RMI	BNA	0	0	0	FRAG	1991 S
104	435	0	0	0	17	SW	TOVOT	FRAG	0	0	0		1991 S
104	436	0	0	0	17	SW	RMI	BNA	0	0	0	FRAG	1991 S
104	437	0	0	0	17	SW	RMI	BNA	0	0	0		1991 S
104	438	0	0	0	17	SW	SORRENCA	BNA	0	0	0	FRAG	1991 S
104	439	0	0	0	17	SW	RMI	BNA	0	0	0	FRAG	1991 S
104	440	0	0	0	17	SW	CALCARIA	BNA	0	0	0	FRAG	1991 S
104	441	0	0	0	17	SW	SORRENCA	BNA	0	0	0	FRAG	1991 S
104	442	0	0	0	17	SW	ESQUIST	BNA	0	0	0		1991 S
104	443	0	0	0	17	SW	RMI	BNA	0	0	0		1991 S
104	444	0	0	0	17	SW	RMI	BNA	0	0	0		1991 S
104	445	0	0	0	17	SW	RMI	BNA	0	0	0	FRAG	1991 S
104	446	0	0	0	17	SW	SORRENCA	BNA	0	0	0	FRAG	1991 S
104	447	0	0	0	17	SW	QUARS	BNA	0	0	0		1991 S
104	448	0	0	0	17	SW	RMI	BNA	0	0	0		1991 S
104	449	0	0	0	17	SW	RMI	BNA	0	0	0		1991 S
104	450	0	0	0	17	SW	RMI	BNA	0	0	0	FRAG	1991 S
104	451	0	0	0	17	SW	RMI	BNA	0	0	0	FRAG	1991 S
104	452	0	0	0	17	SW	QUARS	BNA	0	0	0	FRAC	1991 S
104	453	0	0	0	17	SW	RMI	BNA	0	0	0	FRAG	1991 S
104	454	0	0	0	17	SW	QUARS	BNA	0	0	0	FRAG	1991 S
104	455	0	0	0	18		GRANIT	BNA	0	0	0		1991 S
104	456	0	0	0	18	NE	RMI	BNA	0	0	0		1991 S
104	457	0	0	0	18	NE	RMI	BNA	0	0	0		1991 S
104	458	0	0	0	18	NE	QUARS	BNA	0	0	0	FRAG	1991 S
104	459	0	0	0	18	NE	GRANIT	BNA	0	0	0		1991 S
104	460	0	0	0	18	NE	CALCARIA	BNA	0	0	0	FRAG	1991 S
104	461	0	0	0	18	NE	RMI	BNA	0	0	0	FRAG	1991 S
104	462	0	0	0	18	NE	SORRENCA	BNA	0	0	0	FRAG	1991 S
104	463	0	0	0	18	NE	CALCARIA	BNA	0	0	0	FRAG	1991 S
104	464	0	0	0	18	NE	CALCARIA	BNA	0	0	0		1991 S
104	465	0	0	0	18	NE	RMI	BNA	0	0	0	FRAG	1991 S
104	466	0	0	0	18	NE	SORRENCA	BNA	0	0	0		1991 S
104	467	0	0	0	18	NE	SORRENCA	BNA	0	0	0		1991 S
104	468	0	0	0	18	NE	RMI	BNA	0	0	0		1991 S
104	469	0	0	0	18	NE	SORRENCA	BNA	0	0	0	FRAG	1991 S
104	470	0	0	0	18	NE	RMI	BNA	0	0	0	FRAG	1991 S
104	471	0	0	0	18	NE	SORRENCA	BNA	0	0	0	FRAG	1991 S
104	472	0	0	0	18	NE	SORRENCA	BNA	0	0	0	FRAG	1991 S
104	473	0	0	0	18	NE	SORRENCA	BNA	0	0	0		1991 S
104	474	0	0	0	18	NE	SORRENCA	BNA	0	0	0		1991 S
104	475	0	0	0	18	SE	RMI	BNA	0	0	0	FRAG	1991 S
104	476	0	0	0	18	SE	SORRENCA	BNA	0	0	0	FRAG	1991 S

BOBILA MADURELL  
MAS DURAN  
campanya 1991

E.E. NUM.	X	Y	Zsup	Zinf/	ORIENT	PENDENT	MATERIA	OBJECTE	LONG	AMPL	ESPE	ALTERACIONS OBSERVACIONS	P D	
													ANY	U I
				Talla	SECTOR								N B	T U
104	477	0	0	0	18	SE	RMI	BNA	0	0	0	FRAG	1991	S
104	478	0	0	0	18	SE	RMI	BNA	0	0	0	FRAG	1991	S
104	479	0	0	0	18	SE	RMI	BNA	0	0	0	FRAG	1991	S
104	480	0	0	0	18	SE	QUARS	BNA	0	0	0	FRAG	1991	S
104	481	0	0	0	18	SE	CONGLOME	BNA	0	0	0	FRAG	1991	S
104	482	0	0	0	18	SE	CALCARIA	BNA	0	0	0	FRAG	1991	S
104	483	0	0	0	18	SE	QUARS	BNA	0	0	0		1991	S
104	484	0	0	0	18	SE	QUARS	BNA	0	0	0		1991	S
104	485	0	0	0	18	SE	RMI	BNA	0	0	0	FRAG	1991	S
104	486	0	0	0	18	SE	SORRENCA	BNA	0	0	0		1991	S
104	487	0	0	0	18	SW	RMI	BNA	0	0	0	FRAG	1991	S
104	488	0	0	0	18	SW	RMI	BNA	0	0	0	FRAG	1991	S
104	489	0	0	0	18	SW	CALCARIA	BNA	0	0	0	FRAG	1991	S
104	490	0	0	0	18	SW	RMI	BNA	0	0	0	FRAG	1991	S
104	491	0	0	0	18	SW	RMI	BNA	0	0	0	FRAG	1991	S
104	492	0	0	0	18	SW	RMI	BNA	0	0	0	FRAG	1991	S
104	493	0	0	0	18	SW	RMI	BNA	0	0	0		1991	S
104	494	0	0	0	14		OS	INDET	0	0	0	FRAG	1991	S
104	495	0	0	0	14		OS	DET	0	0	0	VARIS FRAGS	1991	S
104	496	0	0	0	14		OS	INDET	0	0	0	2 FRAGS	1991	S
104	497	0	0	0	14		OS	INDET	0	0	0		1991	S
104	498	0	0	0	14		OS	INDET	0	0	0	3 FRAGS	1991	S
104	499	0	0	0	15		OS	INDET	0	0	0	CREMAT	1991	S
104	500	0	0	0	15	N	OS	DET	0	0	0	MICROFAUNA	1991	S
104	501	0	0	0	15	SE	OS	DET	0	0	0		1991	S
104	502	0	0	0	15	N	OS	DET	0	0	0	2 FRAGS	1991	S
104	503	0	0	0	16	SW	OS	DET	0	0	0		1991	S
104	504	0	0	0	16	NE	OS	DET	0	0	0	VARIS FRAGS	1991	S
104	505	0	0	0	16	W	OS	DET	0	0	0		1991	S
104	506	0	0	0	16	SW	OS	INDET	0	0	0		1991	S
104	507	0	0	0	16		OS	DET	0	0	0	VARIS FRAGS	1991	S
104	508	0	0	0	16	N	OS	DET	0	0	0		1991	S
104	509	0	0	0	16	N	OS	INDET	0	0	0	VARIS FRAGS	1991	S
104	510	0	0	0	16	N	OS	INDET	0	0	0		1991	S
104	511	0	0	0	16	N	OS	INDET	0	0	0		1991	S
104	512	0	0	0	16	NE	OS	DET	0	0	0	VARIS FRAGS	1991	S
104	513	0	0	0	17	W	OS	INDET	0	0	0	VARIS FRAGS	1991	S
104	514	0	0	0	17	W	OS	DET	0	0	0	VARIS FRAGS	1991	S
104	515	0	0	0	17	N	OS	DET	0	0	0	VARIS FRAGS	1991	S
104	516	0	0	0	17	N	OS	INDET	0	0	0	VARIS FRAGS	1991	S
104	517	0	0	0	17	W	OS	DET	0	0	0	VARIS FRAGS	1991	S
104	518	0	0	0	17	SW	OS	DET	0	0	0		1991	S
104	519	0	0	0	17	E	OS	INDET	0	0	0		1991	S
104	520	0	0	0	18	N	OS	DET	0	0	0	VARIS FRAGS	1991	S
104	521	0	0	0	18	NE	OS	DET	0	0	0	MD BOTA	1991	S
104	522	0	0	0	15		ORGANIC	MOLUSC	0	0	0		1991	S
104	523	0	0	0	16	N	ORGANIC	MOLUSC	0	0	0		1991	S
104	524	0	0	0	14	S	RMI	BNA	0	0	0	FRAG	1991	S
104	525	0	0	0	14	S	GRANIT	BNA	0	0	0	FRAG	1991	S
104	526	0	0	0	14	S	SORRENCA	BNA	0	0	0	FRAG	1991	S
104	527	0	0	0	14	S	RMI	BNA	0	0	0		1991	S

BOBILA MADURELL  
MAS DURAN  
campanya 1991

E.E. NUM.	X	Y	Zsup	Zinf/ Talla	ORIENT	PENDENT SECTOR	MATERIA	OBJECTE	LONG	AMPL	ESPE	ALTERACIONS	P D
												OBSERVACIONS	ANY U I N B T U
104	528	0	0	0	14	S	RMI	BNA	0	0	0	FRAG	1991 S
104	529	0	0	0	14	S	RMI	BNA	0	0	0		1991 S
104	530	0	0	0	14	S	RMI	BNA	0	0	0		1991 S
104	531	0	0	0	14	S	CONGLOME	BNA	0	0	0	FRAG	1991 S
104	532	0	0	0	14	S	RMI	BNA	0	0	0	FRAG	1991 S
104	533	0	0	0	14		RMI	BNA	0	0	0	FRAG	1991 S
104	534	0	0	0	15	SE	RMI	BNA	0	0	0	FRAG	1991 S
104	535	0	0	0	15	SW	QUARS	BNA	0	0	0	FRAG	1991 S
104	536	0	0	0	15	SW	QUARS	BNA	0	0	0	FRAG	1991 S
104	537	0	0	0	15	SW	RMI	BNA	0	0	0	FRAC	1991 S
104	538	0	0	0	15	SW	TOVOT	FRAG	0	0	0		1991 S
104	539	0	0	0	15	SW	CALCARIA	BNA	0	0	0	FRAG	1991 S
104	540	0	0	0	15	SW	QUARS	BPI	0	0	0		1991 S
104	541	0	0	0	15	SW	SILEX	BPI	0	0	0		1991 S
104	542	0	0	0	15	SW	RMI	BNA	0	0	0		1991 S
104	543	0	0	0	15	SW	RMI	BPI	0	0	0		1991 S
104	544	0	0	0	15	SW	RMI	BNA	0	0	0	FRAG	1991 S
104	545	0	0	0	15	SW	RMI	BNA	0	0	0	FRAG	1991 S
104	546	0	0	0	15	SW	RMI	BNA	0	0	0		1991 S
104	547	0	0	0	15	SW	RMI	BNA	0	0	0		1991 S
104	548	0	0	0	15	SW	CONGLOME	BNA	0	0	0	FRAG	1991 S
104	549	0	0	0	16	NE	RMI	BNA	0	0	0		1991 S
104	550	0	0	0	16	NE	RMI	BNA	0	0	0	FRAG	1991 S
104	551	0	0	0	16	NE	RMI	BNA	0	0	0	FRAG	1991 S
104	552	0	0	0	16	NE	RMI	BNA	0	0	0	FRAG	1991 S
104	553	0	0	0	16	NE	RMI	BNA	0	0	0	FRAG	1991 S
104	554	0	0	0	16	NE	RMI	BNA	0	0	0	FRAG	1991 S
104	555	0	0	0	16	SW	TOVOT	FRAG	0	0	0		1991 S
104	556	0	0	0	17	SE	RMI	BNA	0	0	0	FRAG	1991 S
104	557	0	0	0	17	SE	SORRENCA	BNA	0	0	0	FRAG	1991 S
104	558	0	0	0	17	SE	RMI	BNA	0	0	0	FRAG	1991 S
104	559	0	0	0	17	SE	RMI	BNA	0	0	0	FRAG	1991 S
104	560	0	0	0	17	SE	GRANIT	BNA	0	0	0	FRAG	1991 S
104	570	0	0	0	17	SE	RMI	BNA	0	0	0	FRAG	1991 S
104	571	0	0	0	17	SE	RMI	BNA	0	0	0		1991 S
104	572	0	0	0	17	SE	SORRENCA	BNA	0	0	0	FRAG	1991 S
104	573	0	0	0	17	SE	RMI	BNA	0	0	0	FRAG	1991 S
104	574	0	0	0	17	SE	RMI	BNA	0	0	0	FRAC	1991 S
104	575	0	0	0	17	SE	RMI	BNA	0	0	0	FRAG	1991 S
104	576	0	0	0	17	SE	CONGLOME	BNA	0	0	0	FRAG	1991 S
104	577	0	0	0	17	SE	SORRENCA	BNA	0	0	0	FRAG	1991 S
104	578	0	0	0	17	SE	QUARS	BNA	0	0	0	FRAG	1991 S
104	579	0	0	0	17	SE	RMI	BNA	0	0	0		1991 S
104	580	0	0	0	17	SE	RMI	BNA	0	0	0	FRAG	1991 S
104	581	0	0	0	17	SE	SORRENCA	BNA	0	0	0	FRAG	1991 S
104	582	0	0	0	17	SE	RMI	BNA	0	0	0	FRAG	1991 S
104	583	0	0	0	17	SE	SORRENCA	BNA	0	0	0	FRAG	1991 S
104	584	0	0	0	17	SE	RMI	BNA	0	0	0	FRAG	1991 S
104	585	0	0	0	17	SW	RMI	BNA	0	0	0	FRAG	1991 S
104	586	0	0	0	17	SW	RMI	BNA	0	0	0	FRAG	1991 S
104	587	0	0	0	17	SW	RMI	BNA	0	0	0	FRAG	1991 S

BOBILA MADURELL  
MAS DURAN  
campanya 1991

E.E. NUM.	X	Y	Zsup	Zinf/ Talla	ORIENT	PENDENT SECTOR	MATERIA	OBJECTE	LONG	AMPL	ESPE	ALTERACIONS	P D
												OBSERVACIONS	ANY U I N B T U
104	588	0	0	0	17	SW	SORRENCA	BNA	0	0	0	FRAG	1991 S
104	589	0	0	0	17	SW	RMI	BNA	0	0	0	FRAG	1991 S
104	590	0	0	0	17	SW	CALCARIA	BPI	0	0	0		1991 S
104	591	0	0	0	17	SW	RMI	BNA	0	0	0	FRAG	1991 S
104	592	0	0	0	17	SW	SORRENCA	BNA	0	0	0	FRAG	1991 S
104	593	0	0	0	17	SW	RMI	BNA	0	0	0	FRAG	1991 S
104	594	0	0	0	17	SW	RMI	BNA	0	0	0	FRAG	1991 S
104	595	0	0	0	17	SE	RMI	BNA	0	0	0	FRAG	1991 S
104	596	0	0	0	18	NW	QUARS	BNA	0	0	0	FRAG	1991 S
104	597	0	0	0	18	SW	SORRENCA	BNA	0	0	0	FRAG	1991 S
104	598	0	0	0	18	SW	RMI	BNA	0	0	0		1991 S
104	599	0	0	0	18	SW	CALCARIA	BNA	0	0	0	FRAC	1991 S
104	600	0	0	0	18	SW	CALCARIA	BNA	0	0	0	FRAG	1991 S
104	601	0	0	0	18	NE	RMI	BNA	0	0	0	FRAG	1991 S
104	602	0	0	0	18	SW	RMI	BNA	0	0	0	FRAG	1991 S
104	603	0	0	0	18	SW	RMI	BNA	0	0	0	FRAG	1991 S
104	604	0	0	0	18	SW	RMI	BNA	0	0	0	FRAC	1991 S
104	605	0	0	0	18	SW	RMI	BNA	0	0	0	FRAG	1991 S
104	606	0	0	0	18	SW	RMI	BNA	0	0	0	FRAG	1991 S
104	607	0	0	0	18	SW	RMI	BNA	0	0	0		1991 S
104	608	0	0	0	18	SW	CONGLOME	BNA	0	0	0		1991 S
104	609	0	0	0	18	SW	RMI	BNA	0	0	0	FRAG	1991 S
104	610	0	0	0	16	SW	CERAMICA	INFORME	0	0	0	2 FRAGS	1991 S
104	611	0	0	0	14	S	SILEX	BPF	0	0	0		1991 S
104	612	0	0	0	17	NE	SILEX	BN2G	0	0	0	FRAG DE LAMINA	1991 S
104	613	0	0	0	15		OS	INDET	0	0	0		1991 S
104	614	0	0	0	16	SE	OS	DET	0	0	0	VARIS FRAGS	1991 S
104	615	0	0	0	16	SW	OS	DET	0	0	0		1991 S
104	616	0	0	0	16	NW	OS	DET	0	0	0		1991 S
104	617	0	0	0	16	NW	OS	DET	0	0	0	CST	1991 S
104	618	0	0	0	16	NW	OS	DET	0	0	0	DENT	1991 S
104	619	0	0	0	16	NW	OS	DET	0	0	0	DENT	1991 S
104	620	0	0	0	16	NW	OS	DET	0	0	0	DENT	1991 S
104	621	0	0	0	16	NW	OS	DET	0	0	0	DENT	1991 S
104	622	0	0	0	16	NW	OS	DET	0	0	0	DENT	1991 S
104	623	0	0	0	16	NW	OS	DET	0	0	0	DENT	1991 S
104	624	0	0	0	17	NW	OS	DET	0	0	0		1991 S
104	625	0	0	0	17	NE	ORGANIC	MOLUSC	0	0	0	PERFORAT	1991 S
104	626	0	0	0	17	SE	QUARSITA	BNA	0	0	0		1991 S
104	627	0	0	0	17	SW	SORRENCA	BNA	0	0	0	FRAG	1991 S
104	628	0	0	0	17	SW	RMI	BNA	0	0	0	FRAG	1991 S
104	629	0	0	0	17	SW	RMI	BNA	0	0	0	FRAG	1991 S
104	630	0	0	0	17	SW	GRANIT	BNA	0	0	0	FRAG	1991 S
105	1	0	0	0	14	SE	CERAMICA	INFORME	0	0	0	2 FRAGS	1991 S
105	2	0	0	0	14	SW	CERAMICA	INFORME	0	0	0	2 FRAGS	1991 S
105	3	0	0	0	14		CERAMICA	INFORME	0	0	0		1991 S
105	4	0	0	0	14	SW	CERAMICA	INFORME	0	0	0		1991 S
105	5	0	0	0	14		CERAMICA	VORA	0	0	0	MAMELO	1991 S
105	6	0	0	0	14	SW	CERAMICA	INFORME	0	0	0	3 FRAGS	1991 S
105	7	0	0	0	14		CERAMICA	INFORME	0	0	0		1991 S
105	8	0	0	0	14		CERAMICA	INFORME	0	0	0		1991 S



BOBILA MADURELL  
MAS DURAN  
campanya 1991

E.E. NUM.	X	Y	Zsup	Zinf/ Talla	ORIENT	PENDENT SECTOR	MATERIA	OBJECTE	LONG	AMPL	ESPE	ALTERACIONS	P D
												OBSERVACIONS	ANY U I N B T U
105	9	0	0	0	14		CERAMICA	APLICA	0	0	0	LLENGETA	1991 S
105	10	0	0	0	14		CERAMICA	INFORME	0	0	0	2 FRAGS	1991 S
105	11	0	0	0	14		CERAMICA	INFORME	0	0	0		1991 S
105	12	0	0	0	15		CERAMICA	INFORME	0	0	0		1991 S
105	13	0	0	0	15		CERAMICA	INFORME	0	0	0		1991 S
105	14	0	0	0	15		CERAMICA	INFORME	0	0	0		1991 S
105	15	0	0	0	15		CERAMICA	INFORME	0	0	0		1991 S
105	16	0	0	0	15		CERAMICA	VORA	0	0	0		1991 S
105	17	0	0	0	15		CERAMICA	INFORME	0	0	0	VARIS FRAGS	1991 S
105	18	0	0	0	15	SE	CERAMICA	INFORME	0	0	0		1991 S
105	19	0	0	0	15	SE	CERAMICA	INFORME	0	0	0		1991 S
105	20	0	0	0	15	SE	CERAMICA	INFORME	0	0	0		1991 S
105	21	0	0	0	15	SW	CERAMICA	INFORME	0	0	0	2 FRAGS	1991 S
105	22	0	0	0	15	SW	CERAMICA	INFORME	0	0	0		1991 S
105	23	0	0	0	15	SW	CERAMICA	VORA	0	0	0		1991 S
105	24	0	0	0	15	SW	CERAMICA	INFORME	0	0	0		1991 S
105	25	0	0	0	15	SW	CERAMICA	INFORME	0	0	0		1991 S
105	26	0	0	0	15	SW	CERAMICA	VORA	0	0	0		1991 S
105	27	0	0	0	16		CERAMICA	INFORME	0	0	0	VARIS FRAGS	1991 S
105	28	0	0	0	16	SW	CERAMICA	INFORME	0	0	0		1991 S
105	29	0	0	0	14		SILEX	BN2G	0	0	0		1991 S
105	30	0	0	0	14		QUARS	BPF	0	0	0		1991 S
105	31	0	0	0	14		SILEX	BPF	0	0	0	FRAG LAMINA	1991 S
105	32	0	0	0	14		SILEX	BP2G	0	0	0		1991 S
105	33	0	0	0	14		SILEX	BN2G	0	0	0	2 FRAGS	1991 S
105	34	0	0	0	15		QUARS	BPF	0	0	0		1991 S
105	35	0	0	0	15		SILEX	BP2G	0	0	0		1991 S
105	36	0	0	0	15		QUARS	BP	0	0	0		1991 S
105	37	0	0	0	15		QUARS	BP	0	0	0		1991 S
105	38	0	0	0	15	SW	SILEX	BP	0	0	0		1991 S
105	39	0	0	0	15	SW	SILEX	BN2G	0	0	0	LAMINETA	1991 S
105	40	0	0	0	14		RMI	BNA	0	0	0	FRAG	1991 S
105	41	0	0	0	14		QUARS	BNA	0	0	0	FRAG	1991 S
105	42	0	0	0	14		CALCARIA	BNA	0	0	0		1991 S
105	43	0	0	0	14		CALCARIA	BNA	0	0	0		1991 S
105	44	0	0	0	14		QUARS	BNA	0	0	0	FRAG	1991 S
105	45	0	0	0	14		RMI	BNA	0	0	0	FRAG	1991 S
105	46	0	0	0	14		RMI	BNA	0	0	0	FRAG	1991 S
105	47	0	0	0	14		CALCARIA	BNA	0	0	0		1991 S
105	48	0	0	0	14		RMI	BNA	0	0	0	FRAG	1991 S
105	49	0	0	0	14		RMI	BNA	0	0	0	FRAG	1991 S
105	50	0	0	0	14		CALCARIA	BNA	0	0	0		1991 S
105	51	0	0	0	14		QUARS	BPI	0	0	0		1991 S
105	52	0	0	0	14		RMI	BNA	0	0	0	FRAG	1991 S
105	53	0	0	0	14		RMI	BNA	0	0	0	FRAG	1991 S
105	54	0	0	0	14		CONGLOME	BNA	0	0	0	FRAG	1991 S
105	55	0	0	0	14		RMI	BNA	0	0	0	FRAG	1991 S
105	56	0	0	0	14	W	RMI	BNA	0	0	0	FRAG	1991 S
105	57	0	0	0	14	W	RMI	BNA	0	0	0	FRAG	1991 S
105	58	0	0	0	14	W	RMI	BNA	0	0	0	FRAG	1991 S
105	59	0	0	0	14	W	RMI	BNA	0	0	0	FRAG	1991 S

BOBILA MADURELL  
MAS DURAN  
campanya 1991

E.E. NUM.	X	Y	Zsup	Zinf/ Talla	ORIENT SECTOR	PENDENT MATERIA	OBJECTE	LONG	AMPL	ESPE	ALTERACIONS	P D
											OBSERVACIONS	ANY U I N B T U
105	60	0	0	0	15	CONGLOME	BNA	0	0	0	FRAG	1991 S
105	61	0	0	0	15	QUARS	BNA	0	0	0	FRAC	1991 S
105	62	0	0	0	15	QUARS	BPI	0	0	0		1991 S
105	63	0	0	0	15	SORRENCA	BNA	0	0	0	FRAG	1991 S
105	64	0	0	0	15	QUARS	BNA	0	0	0	FRAG	1991 S
105	65	0	0	0	15	RMI	BNA	0	0	0	FRAG	1991 S
105	66	0	0	0	15	CALCARIA	BNA	0	0	0		1991 S
105	67	0	0	0	15	RMI	BNA	0	0	0		1991 S
105	68	0	0	0	15	SORRENCA	BNA	0	0	0	FRAG	1991 S
105	69	0	0	0	15	QUARS	BNA	0	0	0	FRAG	1991 S
105	70	0	0	0	15	QUARS	BNA	0	0	0	FRAG	1991 S
105	71	0	0	0	15	SORRENCA	BNA	0	0	0	FRAG	1991 S
105	72	0	0	0	15	SORRENCA	BNA	0	0	0	FRAG	1991 S
105	73	0	0	0	15	SORRENCA	BNA	0	0	0	FRAG	1991 S
105	74	0	0	0	15	QUARS	BNA	0	0	0	FRAG	1991 S
105	75	0	0	0	15	RMI	BNA	0	0	0		1991 S
105	76	0	0	0	15	RMI	BNA	0	0	0	FRAG	1991 S
105	77	0	0	0	15	SILEX	BNA	0	0	0	FRAC	1991 S
105	78	0	0	0	15	RMI	BNA	0	0	0	FRAC	1991 S
105	79	0	0	0	15	SORRENCA	BNA	0	0	0	FRAG	1991 S
105	80	0	0	0	15	RMI	BNA	0	0	0	FRAG	1991 S
105	81	0	0	0	15	RMI	BNA	0	0	0	FRAG	1991 S
105	82	0	0	0	15	RMI	BNA	0	0	0	FRAG	1991 S
105	83	0	0	0	15	RMI	BNA	0	0	0	FRAG	1991 S
105	84	0	0	0	15	CONGLOME	BNA	0	0	0		1991 S
105	85	0	0	0	15	CONGLOME	BNA	0	0	0		1991 S
105	86	0	0	0	15	SORRENCA	BNA	0	0	0	FRAG	1991 S
105	87	0	0	0	15	CALCARIA	BNA	0	0	0	FRAC	1991 S
105	88	0	0	0	15	RMI	BNA	0	0	0	FRAG	1991 S
105	89	0	0	0	15	QUARS	BNA	0	0	0		1991 S
105	90	0	0	0	15	QUARS	BNA	0	0	0	FRAC	1991 S
105	91	0	0	0	15	QUARS	BNA	0	0	0	FRAC	1991 S
105	92	0	0	0	15	CONGLOME	BNA	0	0	0	FRAG	1991 S
105	93	0	0	0	15	SORRENCA	BNA	0	0	0	FRAG	1991 S
105	94	0	0	0	15	RMI	BNA	0	0	0	FRAG	1991 S
105	95	0	0	0	15	RMI	BNA	0	0	0	FRAG	1991 S
105	96	0	0	0	15	SORRENCA	BNA	0	0	0	FRAG	1991 S
105	97	0	0	0	15	RMI	BNA	0	0	0	FRAG	1991 S
105	98	0	0	0	15	RMI	BNA	0	0	0	FRAG	1991 S
105	99	0	0	0	15	RMI	BNA	0	0	0	FRAC	1991 S
105	100	0	0	0	15	RMI	BNA	0	0	0	FRAG	1991 S
105	101	0	0	0	15	QUARS	BNA	0	0	0	FRAC	1991 S
105	102	0	0	0	15	RMI	BNA	0	0	0	FRAG	1991 S
105	103	0	0	0	17	SORRENCA	BNA	0	0	0	FRAG	1991 S
105	104	0	0	0	0	SE	RMI	BNA	0	0	0 2 FRAGS	1991 S
105	105	0	0	0	14	OS	INDET	0	0	0		1991 S
105	106	0	0	0	14	OS	DET	0	0	0	DENT	1991 S
105	107	0	0	0	14	OS	INDET	0	0	0		1991 S
105	108	0	0	0	15	SW	OS	DET	0	0	0	1991 S
105	109	0	0	0	15	OS	INDET	0	0	0		1991 S
105	110	0	0	0	15	W	OS	INDET	0	0	0	1991 S

183

BOBILA MADURELL  
MAS DURAN  
campanya 1991

E.E. NUM.	X	Y	Zsup	Zinf/ Talla	ORIENT	PENDENT SECTOR	MATERIA	OBJECTE	LONG	AMPL	ESPE	ALTERACIONS	P D
												OBSERVACIONS	
105	111	0	0	0	15	SW	OS	INDET	0	0	0		1991 S
105	112	0	0	0	15	SW	OS	INDET	0	0	0		1991 S
105	113	0	0	0	15	W	OS	INDET	0	0	0		1991 S
105	114	0	0	0	15	W	OS	INDET	0	0	0	CREMAT	1991 S
105	115	0	0	0	0		ORGANIC	MOLUSC	0	0	0		1991 S
105	116	0	0	0	0		ORGANIC	MOLUSC	0	0	0		1991 S
105	117	0	0	0	0		ORGANIC	MOLUSC	0	0	0		1991 S
105	118	0	0	0	15		ORGANIC	MOLUSC	0	0	0	PETXINA	1991 S
105	119	0	0	0	15		CONGLOME	BNA	0	0	0	FRAG	1991 S
111	1	0	0	0	11	E	CERAMICA	INFORME	0	0	0		1991 S
111	2	0	0	0	11	E	CERAMICA	INFORME	0	0	0		1991 S
111	3	0	0	0	11	E	CERAMICA	VORA	0	0	0	3 FRAGS	1991 S
111	4	0	0	0	11	E	CERAMICA	INFORME	0	0	0		1991 S
111	5	0	0	0	11	E	CERAMICA	INFORME	0	0	0	REM 33	1991 S
111	6	0	0	0	11	W	CERAMICA	INFORME	0	0	0		1991 S
111	7	0	0	0	11	W	CERAMICA	INFORME	0	0	0		1991 S
111	8	0	0	0	11	W	CERAMICA	INFORME	0	0	0		1991 S
111	9	0	0	0	11	W	CERAMICA	INFORME	0	0	0		1991 S
111	10	0	0	0	11	W	CERAMICA	INFORME	0	0	0		1991 S
111	11	0	0	0	11	W	CERAMICA	INFORME	0	0	0		1991 S
111	12	0	0	0	11	W	CERAMICA	INFORME	0	0	0		1991 S
111	13	0	0	0	11	W	CERAMICA	INFORME	0	0	0	3 FRAGS	1991 S
111	14	0	0	0	11	W	CERAMICA	INFORME	0	0	0		1991 S
111	15	0	0	0	11	W	CERAMICA	INFORME	0	0	0	5 FRAGS	1991 S
111	16	0	0	0	11	W	CERAMICA	INFORME	0	0	0	INFLEXIO	1991 S
111	17	0	0	0	11	W	CERAMICA	INFORME	0	0	0		1991 S
111	18	0	0	0	11	W	CERAMICA	INFORME	0	0	0		1991 S
111	19	0	0	0	11	W	CERAMICA	INFORME	0	0	0		1991 S
111	20	0	0	0	11	W	CERAMICA	INFORME	0	0	0		1991 S
111	21	0	0	0	12	E	CERAMICA	INFORME	0	0	0		1991 S
111	22	0	0	0	12	E	CERAMICA	CARENA	0	0	0		1991 S
111	23	0	0	0	12	E	CERAMICA	INFORME	0	0	0		1991 S
111	24	0	0	0	12	E	CERAMICA	INFORME	0	0	0		1991 S
111	25	0	0	0	12	E	CERAMICA	INFORME	0	0	0	DECORADA INCISI	1991 S
111	26	0	0	0	12	E	CERAMICA	INFORME	0	0	0	DECORADA INCISI	1991 S
111	27	0	0	0	12	E	CERAMICA	INFORME	0	0	0		1991 S
111	28	0	0	0	12	E	CERAMICA	INFORME	0	0	0	2 FRAGS	1991 S
111	29	0	0	0	12	E	CERAMICA	INFORME	0	0	0		1991 S
111	30	0	0	0	12	E	CERAMICA	VORA	0	0	0		1991 S
111	31	0	0	0	12	E	CERAMICA	INFORME	0	0	0	2 FRAGS	1991 S
111	32	0	0	0	12	E	CERAMICA	INFORME	0	0	0	2 FRAGS	1991 S
111	33	0	0	0	12	W	CERAMICA	VORA	0	0	0	MAMELO PERFORAT	1991 S
111	34	0	0	0	12	W	CERAMICA	VORA	0	0	0		1991 S
111	35	0	0	0	12	W	CERAMICA	VORA	0	0	0	2 FRAGS	1991 S
111	36	0	0	0	12	W	CERAMICA	NANSA	0	0	0		1991 S
111	37	0	0	0	13	E	CERAMICA	INFORME	0	0	0	DECORADA INCISI	1991 S
111	38	0	0	0	13	E	CERAMICA	INFORME	0	0	0		1991 S
111	39	0	0	0	13	E	CERAMICA	VORA	0	0	0		1991 S
111	40	0	0	0	13	W	CERAMICA	INFORME	0	0	0		1991 S
111	41	0	0	0	13	E	CERAMICA	INFORME	0	0	0		1991 S
111	42	0	0	0	13	E	CERAMICA	INFORME	0	0	0		1991 S

BOBILA MADURELL  
MAS DURAN  
campanya 1991

E.E. NUM.	X	Y	Zsup	Zinf/ Talla	ORIENT	PENDENT SECTOR	MATERIA	OBJECTE	LONG	AMPL	ESPE	ALTERACIONS OBSERVACIONS	P D				
													ANY	U	I	T U	
111	43	0	0	0	13	E	CERAMICA	INFORME	0	0	0		1991	S			
111	44	0	0	0	13	W	CERAMICA	INFORME	0	0	0		1991	S			
111	45	0	0	0	13	W	CERAMICA	INFORME	0	0	0		1991	S			
111	46	0	0	0	13	W	CERAMICA	INFORME	0	0	0		1991	S			
111	47	0	0	0	13	W	CERAMICA	VORA	0	0	0	VARIS FRAGS	1991	S			
111	48	0	0	0	11	W	SILEX	BPF	0	0	0	FRAG LAMINA	1991	S			
111	49	0	0	0	11	W	SILEX	BPF	0	0	0	FRAG LAMINA	1991	S			
111	50	0	0	0	11	W	SILEX	BPF	0	0	0	FRAG LAMINA	1991	S			
111	51	0	0	0	11	W	SILEX	BP	0	0	0	LAMINA	1991	S			
111	52	0	0	0	11	W	SILEX	BPF	0	0	0	FRAG LAMINA	1991	S			
111	53	0	0	0	11	W	SILEX	BPF	0	0	0	FRAG LAMINA	1991	S			
111	54	0	0	0	11	W	SILEX	BPF	0	0	0	FRAG LAMINA	1991	S			
111	55	0	0	0	11	W	SILEX	BPF	0	0	0	FRAG LAMINA	1991	S			
111	56	0	0	0	11	W	SILEX	BPF	0	0	0	FRAG LAMINA	1991	S			
111	57	0	0	0	11	W	RMI	BNE	0	0	0	DESTRAL	1991	S			
111	58	0	0	0	12	E	SILEX	BPF	0	0	0	FRAG LAMINA	1991	S			
111	59	0	0	0	12	W	SILEX	BPF	0	0	0	FRAG LAMINA	1991	S			
111	60	0	0	0	12	W	SILEX	BPF	0	0	0	FRAG LAMINA	1991	S			
111	61	0	0	0	13	W	SILEX	BP	0	0	0		1991	S			
111	62	0	0	0	13	W	SILEX	BPF	0	0	0	AMB CONCRECIO	1991	S			
111	63	0	0	0	11	E	RMI	BNA	0	0	0	FRAG	1991	S			
111	64	0	0	0	11	E	QUARS	BNA	0	0	0		1991	S			
111	65	0	0	0	11	E	SORRENCA	BNA	0	0	0	FRAG ALTERAT	1991	S			
111	66	0	0	0	11	E	RMI	BNE	0	0	0		1991	S			
111	67	0	0	0	11	E	CONGLOME	BNE	0	0	0	FRAG MOLI	1991	S			
111	68	0	0	0	11	E	RMI	BNA	0	0	0	FRAG N.G.	1991	S			
111	69	0	0	0	11	E	SORRENCA	BNA	0	0	0	FRAG N.G.	1991	S			
111	70	0	0	0	11	E	RMI	BNA	0	0	0	FRAG N.G.	1991	S			
111	71	0	0	0	11	E	RMI	BNA	0	0	0	FRAG N.G.	1991	S			
111	72	0	0	0	11	E	CONGLOME	BNA	0	0	0	FRAG N.G.	1991	S			
111	73	0	0	0	11	E	CONGLOME	BNE	0	0	0	FRAG MOLI	1991	S			
111	74	0	0	0	11	W	RMI	BNA	0	0	0	FRAG N.G.	1991	S			
111	75	0	0	0	11	W	SORRENCA	BNA	0	0	0	FRAG N.G.	1991	S			
111	76	0	0	0	11	W	CALCARIA	BNA	0	0	0	FRAC	1991	S			
111	77	0	0	0	11	W	RMI	BNE	0	0	0	FRAG	1991	S			
111	78	0	0	0	11	W	RMI	BNA	0	0	0	FRAG N.G.	1991	S			
111	79	0	0	0	11	W	RMI	BNE	0	0	0	FRAG	1991	S			
111	80	0	0	0	11	W	RMI	BNA	0	0	0	FRAG	1991	S			
111	81	0	0	0	11	W	RMI	BNA	0	0	0	FRAG N.G.	1991	S			
111	82	0	0	0	11	W	RMI	BNA	0	0	0	FRAG	1991	S			
111	83	0	0	0	12	E	CALCARIA	BNA	0	0	0	N.G.	1991	S			
111	84	0	0	0	12	E	CALCARIA	BNA	0	0	0	N.G.	1991	S			
111	85	0	0	0	12	E	GRANIT	BNA	0	0	0	FRAG N.G.	1991	S			
111	86	0	0	0	12	E	RMI	BNA	0	0	0	FRAG N.G.	1991	S			
111	87	0	0	0	12	E	SORRENCA	BNA	0	0	0	FRAG N.G.	1991	S			
111	88	0	0	0	12	E	RMI	BNA	0	0	0	FRAG N.G.	1991	S			
111	89	0	0	0	12	W	RMI	BNA	0	0	0	FRAG N.G.	1991	S			
111	90	0	0	0	12	W	CALCARIA	BNA	0	0	0		1991	S			
111	91	0	0	0	12	W	CALCARIA	BNA	0	0	0		1991	S			
111	92	0	0	0	12	W	RMI	BNE	0	0	0		1991	S			
111	93	0	0	0	12	W	CONGLOME	BNA	0	0	0	FRAG	1991	S			

BOBILA MADURELL  
MAS DURAN  
campanya 1991

E.E. NUM.	X	Y	Zsup	Zinf/ Talla	ORIENT	PENDENT SECTOR	MATERIA	OBJECTE	LONG	AMPL	ESPE	ALTERACIONS OBSERVACIONS	P D			
													ANY	U	I	
111	94	0	0	0	13	E	RMI	BNA	0	0	0	FRAG N.G.	1991	S		
111	95	0	0	0	11	E	SILEX	BPF	0	0	0	FRAG LAMINA	1991	S		
111	96	0	0	0	11	E	OS	INDET	0	0	0		1991	S		
111	97	0	0	0	11	E	OS	INDET	0	0	0		1991	S		
111	98	0	0	0	12	E	OS	BN2G	0	0	0	ESPATULA 4 FRAG	1991	S		
111	99	0	0	0	11	W	OS	INDET	0	0	0		1991	S		
111	100	0	0	0	11	W	OS	INDET	0	0	0		1991	S		
111	101	0	0	0	11	W	OS	INDET	0	0	0		1991	S		
111	102	0	0	0	11	W	OS	INDET	0	0	0		1991	S		
111	103	0	0	0	11	W	OS	INDET	0	0	0		1991	S		
111	104	0	0	0	11	W	OS	INDET	0	0	0		1991	S		
111	105	0	0	0	11	W	OS	INDET	0	0	0		1991	S		
111	106	0	0	0	11	W	OS	BN2G	0	0	0	2 FRAGS	1991	S		
111	107	0	0	0	11	W	OS	BN2G	0	0	0	2 FRAGS	1991	S		
111	108	0	0	0	11	W	OS	INDET	0	0	0		1991	S		
111	109	0	0	0	11	W	OS	INDET	0	0	0		1991	S		
111	110	0	0	0	11	W	OS	INDET	0	0	0		1991	S		
111	111	0	0	0	11	W	OS	INDET	0	0	0	CREMAT	1991	S		
111	112	0	0	0	11	W	OS	INDET	0	0	0	CREMAT	1991	S		
111	113	0	0	0	12	E	OS	INDET	0	0	0		1991	S		
111	114	0	0	0	12	E	OS	INDET	0	0	0		1991	S		
111	115	0	0	0	12	E	OS	BN2G	0	0	0	FRAG PUNXO	1991	S		
111	116	0	0	0	12	E	OS	BN2G	0	0	0	PUNXO 2 FRAGS	1991	S		
111	117	0	0	0	12	E	OS	BN2G	0	0	0		1991	S		
111	118	0	0	0	12	E	OS	INDET	0	0	0	4 FRAGS	1991	S		
111	119	0	0	0	12	E	OS	BN2G	0	0	0	ESPATULA 2 FRAG	1991	S		
111	120	0	0	0	12	E	OS	INDET	0	0	0	2 FRAGS	1991	S		
111	121	0	0	0	12	W	OS	BN2G	0	0	0	4 FRAGS	1991	S		
111	122	0	0	0	12	W	OS	BN2G	0	0	0		1991	S		
111	123	0	0	0	12	W	OS	INDET	0	0	0		1991	S		
111	124	0	0	0	12	W	OS	DET	0	0	0	DENT VARIS FRAG	1991	S		
111	125	0	0	0	12	W	OS	BN2G	0	0	0		1991	S		
111	126	0	0	0	12	W	OS	INDET	0	0	0		1991	S		
111	127	0	0	0	12	W	OS	DET	0	0	0	FRAG HOM	1991	S		
111	128	0	0	0	12	W	OS	DET	0	0	0	EI TREBALLAT?	1991	S		
111	129	0	0	0	13	E	OS	INDET	0	0	0		1991	S		
111	130	0	0	0	13	E	OS	INDET	0	0	0		1991	S		
111	131	0	0	0	13	E	OS	INDET	0	0	0	TRABALLAT?	1991	S		
111	132	0	0	0	13	W	OS	BN2G	0	0	0	PLAQUETA PERFOR	1991	S		
111	133	0	0	0	13	W	OS	BN2G	0	0	0	FRAG PUNXO	1991	S		
111	134	0	0	0	13	W	OS	BN2G	0	0	0	FRAG PUNXO	1991	S		
111	135	0	0	0	13	W	OS	DET	0	0	0	DENT	1991	S		
111	136	0	0	0	13	W	OS	DET	0	0	0	DENT	1991	S		
111	137	0	0	0	13	W	OS	INDET	0	0	0	CREMAT	1991	S		
111	138	0	0	0	13	W	OS	INDET	0	0	0	4 FRAGS	1991	S		
111	139	0	0	0	11	W	CERAMICA	INFORME	0	0	0	VARIS FRAGS	1991	S		
111	140	0	0	0	11	W	CERAMICA	INFORME	0	0	0	VARIS FRAGS	1991	S		
111	141	0	0	0	11	W	CERAMICA	INFORME	0	0	0	2 FRAGS	1991	S		
111	142	0	0	0	11	W	CERAMICA	INFORME	0	0	0	3 FRAGS	1991	S		
111	143	0	0	0	11	W	CERAMICA	CARENA	0	0	0	VARIS FRAGS	1991	S		
111	144	0	0	0	11	W	CERAMICA	INFORME	0	0	0	2 FRAGS	1991	S		

BOBILA MADURELL  
MAS DURAN  
campanya 1991

E.E. NUM.	X	Y	Zsup	Zinf/ Talla	ORIENT	PENDENT SECTOR	MATERIA	OBJECTE	LONG	AMPL	ESPE	ALTERACIONS	P D
												OBSERVACIONS	
111	145	0	0	0	11	W	CERAMICA	INFORME	0	0	0	VARIS FRAGS	1991 S
111	146	0	0	0	12	W	CERAMICA	INFORME	0	0	0	VARIS FRAGS	1991 S
111	147	0	0	0	12	W	CERAMICA	INFORME	0	0	0	VARIS FRAGS	1991 S
111	148	0	0	0	12	W	CERAMICA	INFORME	0	0	0	2 FRAGS	1991 S
111	149	0	0	0	12	W	CERAMICA	INFORME	0	0	0		1991 S
111	150	0	0	0	12	W	CERAMICA	INFORME	0	0	0		1991 S
111	151	0	0	0	12	W	CERAMICA	VORA	0	0	0		1991 S
111	152	0	0	0	12	W	CERAMICA	INFORME	0	0	0	2 FRAGS	1991 S
111	153	0	0	0	12	E	OS	INDET	0	0	0		1991 S
112	1	0	0	0	996	E	OS	DET	0	0	0	CRA	1991 S
112	2	0	0	0	955	E	OS	DET	0	0	0	MA D Pal	1991 S
112	3	0	0	0	980	E	OS	DET	0	0	0	CB D	1991 S
112	4	0	0	0	970	E	OS	DET	0	0	0	RA D	1991 S
112	5	0	0	0	950	E	OS	DET	0	0	0	CL D	1991 S
112	6	0	0	0	940	E	OS	DET	0	0	0	CL E	1991 S
112	7	0	0	0	995	E	OS	DET	0	0	0	CST D	1991 S
112	8	0	0	0	960	E	OS	DET	0	0	0	CST E	1991 S
112	9	0	0	0	885	E	OS	DET	0	0	0	HU E	1991 S
112	10	0	0	0	930	E	OS	DET	0	0	0	E E	1991 S
112	11	0	0	0	980	E	CERAMICA	INFORME	0	0	0		1991 S
112	12	0	0	0	995	E	OS	DET	0	0	0	HU D	1991 S
112	13	0	0	0	1000	E	OS	DET	0	0	0	E D FRAG	1991 S
112	14	0	0	0	1009	SW	CONGLOME	BNE	0	0	0	FRAG MOLI	1991 S
112	15	0	0	0	1000	P	CONGLOME	BNA	0	0	0	FRAG	1991 S
112	16	0	0	0	988	SW	INDET	BNA	0	0	0	FRAG	1991 S
112	17	0	0	0	995	P	RMI	BNA	0	0	0	FRAG N.G.	1991 S
112	18	0	0	0	988	S	RMI	BNA	0	0	0	FRAG N.G.	1991 S
112	19	0	0	0	995	SW	RMI	BNA	0	0	0	FRAG N.G.	1991 S
112	20	0	0	0	965	SE	RMI	BNA	0	0	0	FRAG N.G.	1991 S
112	21	0	0	0	950	W	RMI	BNA	0	0	0	FRAG N.G.	1991 S
112	22	0	0	0	956	E	CONGLOME	BNA	0	0	0	FRAG N.G.	1991 S
112	23	0	0	0	982	P	RMI	BNA	0	0	0	N.G.	1991 S
112	24	0	0	0	1012	S	CONGLOME	BNE	0	0	0	MOLI	1991 S
112	25	0	0	0	1001	SW	RMI	BNA	0	0	0	FRAG	1991 S
112	26	0	0	0	980	SE	RMI	BNA	0	0	0	FRAG	1991 S
112	27	0	0	0	990	S	RMI	BNA	0	0	0	N.G.	1991 S
112	28	0	0	0	1111	SE	CERAMICA	INFORME	0	0	0		1991 S
112	29	0	0	0	1005	N	ESQUIST	BNA	0	0	0	N.G.	1991 S
112	30	0	0	0	1001	NW	RMI	BNA	0	0	0	FRAG N.G.	1991 S
112	31	0	0	0	1001	W	CALCARIA	BNA	0	0	0	N.G.	1991 S
112	32	0	0	0	990	W	INDET	BNA	0	0	0	FRAG	1991 S
112	33	0	0	0	990	SW	QUARS	BNA	0	0	0	FRAG	1991 S
112	34	0	0	0	980	N	SORRENCA	BNA	0	0	0	N.G.	1991 S
112	35	0	0	0	1005	P	RMI	BNA	0	0	0	FRAG	1991 S
112	36	0	0	0	983	S	CERAMICA	INFORME	0	0	0		1991 S
112	37	0	0	0	995	SW	INDET	BNA	0	0	0	FRAG	1991 S
112	38	0	0	0	995	NE	QUARS	BNA	0	0	0		1991 S
112	39	0	0	0	1000	SE	SORRENCA	BNA	0	0	0	FRAG N.G.	1991 S
112	40	0	0	0	966	SW	RMI	BNA	0	0	0	FRAG	1991 S
112	41	0	0	0	990	P	CONGLOME	BNA	0	0	0	FRAG N.G.	1991 S
112	42	0	0	0	982	SW	CERAMICA	VAS	0	0	0	REMUNTAT	1991 S

BOBILA MADURELL  
MAS DURAN  
campanya 1991

E.E. NUM.	X	Y	Zsup	Zinf/ Talla	ORIENT	PENDENT SECTOR	MATERIA	OBJECTE	LONG	AMPL	ALTERACIONS		P D ANY U I N B T U
											ESPE	OBSERVACIONS	
112	43	0	0	0	980	SW	CERAMICA	INFORME	0	0	0	REM 42	1991 S
112	44	0	0	0	1000	S	CERAMICA	INFORME	0	0	0	REM 42	1991 S
112	45	0	0	0	1000	W	INDET	BNE	0	0	0	BNE?	1991 S
112	46	0	0	0	989	NE	CERAMICA	INFORME	0	0	0	REM 42	1991 S
112	47	0	0	0	1009	NW	CERAMICA	INFORME	0	0	0	REM 42	1991 S
112	48	0	0	0	1001	P	CERAMICA	INFORME	0	0	0		1991 S
112	49	0	0	0	980	N	SILEX	BNE	0	0	0		1991 S
112	50	0	0	0	993	S	RMI	BNA	0	0	0	FRAG	1991 S
112	51	0	0	0	999	SE	RMI	BNA	0	0	0	FRAG N.G.	1991 S
112	52	0	0	0	975	S	CERAMICA	VORA	0	0	0	REM 42	1991 S
112	53	0	0	0	1005	SE	CERAMICA	INFORME	0	0	0	REM 42	1991 S
112	54	0	0	0	997	NW	CERAMICA	INFORME	0	0	0		1991 S
112	55	0	0	0	1000	P	CERAMICA	VORA	0	0	0	REM 42	1991 S
112	56	0	0	0	1000	S	INDET	BNA	0	0	0	FRAG	1991 S
112	57	0	0	0	983	P	CERAMICA	INFORME	0	0	0		1991 S
112	58	0	0	0	990	P	CERAMICA	NANSA	0	0	0		1991 S
112	59	0	0	0	1020	P	CERAMICA	INFORME	0	0	0	REM 42	1991 S
112	60	0	0	0	976	P	CERAMICA	INFORME	0	0	0	REM 42	1991 S
112	61	0	0	0	990	P	CERAMICA	INFORME	0	0	0	REM 42	1991 S
112	62	0	0	0	1053	S	RMI	BNA	0	0	0		1991 S
112	63	0	0	0	1062	P	INDET	BNA	0	0	0		1991 S
112	64	0	0	0	1069	P	CERAMICA	INFORME	0	0	0	REM 42	1991 S
112	65	0	0	0	1109	P	CERAMICA	INFORME	0	0	0	REM 42	1991 S
112	66	0	0	0	1016	P	CERAMICA	INFORME	0	0	0	REM 42	1991 S
112	67	0	0	0	998	N	ORGANIC	MOLUSC	0	0	0		1991 S
112	68	0	0	0	1027	P	CERAMICA	INFORME	0	0	0	REM 42	1991 S
112	69	0	0	0	1020	SE	CONGLOME	BNA	0	0	0	FRAG N.G.	1991 S
112	70	0	0	0	1012	P	SILEX	BPI	0	0	0		1991 S
112	71	0	0	0	1029	W	RMI	BNA	0	0	0	N.G.	1991 S
112	72	0	0	0	1021	V	CERAMICA	NANSA	0	0	0	ARRANCAMENT	1991 S
112	73	0	0	0	1037	P	QUARS	BNA	0	0	0	2 FRAGS N.G.	1991 S
112	74	0	0	0	1039	P	CERAMICA	INFORME	0	0	0		1991 S
112	75	0	0	0	1040	P	OS	INDET	0	0	0		1991 S
112	76	0	0	0	1041	NE	RMI	BNA	0	0	0	FRAG N.G.	1991 S
112	77	0	0	0	1015	P	RMI	BNA	0	0	0	FRAG N.G.	1991 S
112	78	0	0	0	1025	P	RMI	BNA	0	0	0	FRAG N.G.	1991 S
112	79	0	0	0	1012	P	RMI	BNA	0	0	0	FRAG N.G.	1991 S
112	80	0	0	0	1000	S	RMI	BNA	0	0	0	FRAG N.G.	1991 S
112	81	0	0	0	1020	P	RMI	BNA	0	0	0	FRAG N.G.	1991 S
112	82	0	0	0	1016	P	RMI	BNA	0	0	0	FRAG N.G.	1991 S
112	83	0	0	0	1022	P	INDET	BNA	0	0	0	N.G.	1991 S
112	84	0	0	0	1010	P	RMI	BNA	0	0	0	FRAG	1991 S
112	85	0	0	0	1000	S	QUARS	BNA	0	0	0	FRAG	1991 S
112	86	0	0	0	984	SE	OS	DET	0	0	0		1991 S
112	87	0	0	0	1010	SW	CONGLOME	BNA	0	0	0	FRAG N.G.	1991 S
112	88	0	0	0	990	NE	OS	DET	0	0	0		1991 S
112	89	0	0	0	1006	E	SORRENCA	BNA	0	0	0	FRAG	1991 S
112	90	0	0	0	1024	E	RMI	BNA	0	0	0	FRAG N.G.	1991 S
112	91	0	0	0	1019	SE	CONGLOME	BNA	0	0	0	FRAG N.G.	1991 S
112	93	0	0	0	1000	SE	RMI	BNA	0	0	0	FRAG N.G.	1991 S
112	94	0	0	0	1019	NE	INDET	BNA	0	0	0	N.G.	1991 S

BOBILA MADURELL  
MAS DURAN  
campanya 1991

E.E. NUM.	X	Y	Zsup	Zinf/ Talla	ORIENT	PENDENT SECTOR	MATERIA	OBJECTE	LONG	AMPL	ESPE	ALTERACIONS OBSERVACIONS	P D			
													ANY	U	I	N B
													T	U		
112	95	0	0	0	977	P	RMI	BNA	0	0	0	FRAG N.G.	1991	S		
112	96	0	0	0	1002	SE	CALCARIA	BNA	0	0	0	FRAG	1991	S		
112	97	0	0	0	996	SE	RMI	BNA	0	0	0	FRAG N.G.	1991	S		
112	98	0	0	0	1005	SE	CALCARIA	BNA	0	0	0	FRAG N.G.	1991	S		
112	99	0	0	0	1003	SW	SORRENCA	BNA	0	0	0	FRAG N.G.	1991	S		
112	100	0	0	0	999	SW	RMI	BNA	0	0	0	FRAG N.G.	1991	S		
112	101	0	0	0	990	SW	CONGLOME	BNA	0	0	0	FRAG N.G.	1991	S		
112	102	0	0	0	985	SW	RMI	BNA	0	0	0	FRAG	1991	S		
112	103	0	0	0	1004	SW	CERAMICA	PANXA	0	0	0		1991	S		
112	104	0	0	0	963	SW	INDET	BNA	0	0	0	FRAG N.G.	1991	S		
112	105	0	0	0	970	SW	INDET	BNA	0	0	0	FRAG N.G.	1991	S		
112	106	0	0	0	964	SW	RMI	BNA	0	0	0	N.G.	1991	S		
112	107	0	0	0	9	E	CERAMICA	INFORME	0	0	0		1991	S		
112	108	0	0	0	9	W	CERAMICA	INFORME	0	0	0	REM 42	1991	S		
112	109	0	0	0	9	W	CERAMICA	INFORME	0	0	0		1991	S		
112	110	0	0	0	9	W	CERAMICA	INFORME	0	0	0	REM 42	1991	S		
112	111	0	0	0	10	W	CERAMICA	INFORME	0	0	0	REM 42	1991	S		
112	112	0	0	0	11	W	CERAMICA	VORA	0	0	0	REM 42	1991	S		
112	113	0	0	0	11	W	CERAMICA	INFORME	0	0	0	REM 42	1991	S		
112	114	0	0	0	11	W	CERAMICA	INFORME	0	0	0	REM 42	1991	S		
112	115	0	0	0	11	W	CERAMICA	INFORME	0	0	0	REM 42	1991	S		
112	116	0	0	0	11	W	CERAMICA	INFORME	0	0	0		1991	S		
112	117	0	0	0	11	W	CERAMICA	INFORME	0	0	0	REM 42	1991	S		
112	118	0	0	0	11	W	CERAMICA	INFORME	0	0	0		1991	S		
112	119	0	0	0	11	W	CERAMICA	INFORME	0	0	0	REM 42	1991	S		
112	120	0	0	0	11		CERAMICA	INFORME	0	0	0		1991	S		
112	121	0	0	0	9	E	SILEX	BPF	0	0	0	FRAG LAMINA	1991	S		
112	122	0	0	0	10		INDET	BNE	0	0	0	FRAG DESTRAL	1991	S		
112	123	0	0	0	10		INDET	BNE	0	0	0	DESTRAL	1991	S		
112	124	0	0	0	9	W	RMI	BNA	0	0	0	FRAG N.G.	1991	S		
112	125	0	0	0	9	W	RMI	BNA	0	0	0	FRAG N.G.	1991	S		
112	126	0	0	0	9	E	GRANIT	BNA	0	0	0	FRAG N.G.	1991	S		
112	127	0	0	0	9	W	QUARS	BNA	0	0	0	FRAG	1991	S		
112	128	0	0	0	9	W	CALCARIA	BNA	0	0	0	FRAG N.G.	1991	S		
112	129	0	0	0	11	W	RMI	BNA	0	0	0	FRAG N.G.	1991	S		
112	130	0	0	0	11	W	RMI	BNA	0	0	0	FRAG N.G.	1991	S		
112	131	0	0	0	11	W	GRANIT	BNA	0	0	0	FRAG N.G.	1991	S		
112	132	0	0	0	11	W	RMI	BNA	0	0	0	FRAG N.G.	1991	S		
112	133	0	0	0	11	W	INDET	BNA	0	0	0	FRAG	1991	S		
112	134	0	0	0	11	W	RMI	BNA	0	0	0	FRAG N.G.	1991	S		
112	135	0	0	0	9	E	OS	INDET	0	0	0		1991	S		
112	136	0	0	0	9	E	OS	INDET	0	0	0		1991	S		
112	137	0	0	0	9	E	OS	INDET	0	0	0		1991	S		
112	138	0	0	0	9	E	OS	INDET	0	0	0		1991	S		
112	139	0	0	0	9	W	OS	INDET	0	0	0		1991	S		
112	140	0	0	0	10	W	OS	INDET	0	0	0		1991	S		
112	141	0	0	0	11	W	OS	INDET	0	0	0		1991	S		
112	142	0	0	0	11		OS	DET	0	0	0	DENT	1991	S		
112	143	0	0	0	11		OS	INDET	0	0	0		1991	S		
112	144	0	0	0	11		OS	DET	0	0	0		1991	S		
112	145	0	0	0	11	W	RMI	BNA	0	0	0	N.G.	1991	S		



BOBILA MADURELL  
MAS DURAN  
campanya 1991

E.E. NUM.	X	Y	Zsup	Zinf/ Talla	ORIENT	PENDENT SECTOR	MATERIA	OBJECTE	LONG	AMPL	ESPE	ALTERACIONS	P D	
												OBSERVACIONS	ANY U I N B T U	
112	146	0	0	0	10		CONGLOME	BNE	0	0	0	MOLI	1991 S	
113	1	0	0	1754	1768	NW-SE	NW	OS	DET	0	0	0	HU	1991 S
113	2	0	0	0	1751	N-S	V	SILEX	BP	0	0	0		1991 S
113	3	0	0	0	1758	NW-SE	E	SILEX	BP	0	0	0		1991 S
113	4	0	0	0	1750			OS	DET	0	0	0	DENT	1991 S
113	5	0	0	0	1756			OS	DET	0	0	0	DENT	1991 S
113	6	0	0	0	1745			OS	DET	0	0	0	DENT	1991 S
113	7	0	0	0	1742			OS	DET	0	0	0	DENT	1991 S
113	8	0	0	0	1740			OS	DET	0	0	0	DENT	1991 S
113	9	0	0	0	1760			OS	DET	0	0	0	M2	1991 S
113	10	0	0	0	1760			OS	DET	0	0	0	M Sup	1991 S
113	11	0	0	0	1760			OS	DET	0	0	0	FRAG COSTAL	1991 S
113	12	0	0	0	1755			OS	DET	0	0	0	FRAG COSTAL	1991 S
113	13	0	0	0	1775			OS	BN2G	0	0	0	PUNXO	1991 S
113	14	0	0	0	1775			CERAMICA	INFORME	0	0	0		1991 S
113	15	0	0	0	1760			OS	DET	0	0	0	FRAG COSTAL	1991 S
113	16	0	0	0	1760			OS	DET	0	0	0	DENTINA INCISIV	1991 S
113	17	0	0	1770	1785			OS	DET	0	0	0	E D Fase Ant	1991 S
113	18	0	0	0	1760			OS	DET	0	0	0	FA OCND F. Lat	1991 S
113	19	0	0	0	1760			OS	DET	0	0	0	FRAG COSTAL	1991 S
113	20	0	0	0	1780			SILEX	BN2G	0	0	0	LAMINA	1991 S
113	21	0	0	0	1770			SILEX	BN2G	0	0	0	TRAPECI F.Ven	1991 S
113	22	0	0	0	1800			OS	DET	0	0	0	PUB?	1991 S
113	23	0	0	0	1825			OS	DET	0	0	0	ED FE	1991 S
113	24	0	0	0	1850			OS	DET	0	0	0	RT	1991 S
113	25	0	0	0	1860			RMI	BNE	0	0	0	MOLETA	1991 S
113	26	0	0	1740	1770			OS	DET	0	0	0	TI + PR	1991 S
113	27	0	0	1720	1780			OS	DET	0	0	0	FE	1991 S
113	28	0	0	0	1875			OS	INDET	0	0	0	AMB CONCRECIO	1991 S
113	29	0	0	0	1875			OS	INDET	0	0	0	AMB CONCRECIO	1991 S
113	30	0	0	0	1765			OS	DET	0	0	0	M2 D	1991 S
113	31	0	0	0	1780			OS	DET	0	0	0	M1 D	1991 S
113	32	0	0	0	1780			OS	DET	0	0	0	M2 D	1991 S
113	33	0	0	0	1780			OS	DET	0	0	0	P1 D	1991 S
113	34	0	0	0	1780			OS	DET	0	0	0	C1 D	1991 S
113	35	0	0	0	1780			OS	DET	0	0	0	I2 D	1991 S
113	36	0	0	1760	1780			OS	DET	0	0	0	CL V + VT CE	1991 S
113	37	0	0	0	1780			OS	INDET	0	0	0	F. MEDULAR DIAF	1991 S
113	38	0	0	0	1785			SILEX	BP	0	0	0	LAMINA	1991 S
113	39	0	0	0	1770			SILEX	BP	0	0	0		1991 S
113	40	0	0	0	1785			CALAITA	DENA	0	0	0		1991 S
113	41	0	0	0	1785			CALAITA	DENA	0	0	0		1991 S
113	42	0	0	0	1795			CALAITA	DENA	0	0	0		1991 S
113	43	0	0	0	1790			CALAITA	DENA	0	0	0		1991 S
113	44	0	0	0	1765			OS	DET	0	0	0	1M VOLTANT VT	1991 S
113	45	0	0	0	1770			OS	DET	0	0	0	GERMEN DENTARI	1991 S
113	46	0	0	0	1765			OS	DET	0	0	0	M2	1991 S
113	47	0	0	0	1790			OS	DET	0	0	0	CST FLOTANT	1991 S
113	48	0	0	1785	1800			OS	DET	0	0	0	E E	1991 S
113	49	0	0	1755	1785			OS	DET	0	0	0	HU E	1991 S
113	50	0	0	0	1770			OS	DET	0	0	0	MC	1991 S

BOBILA MADURELL  
MAS DURAN  
campanya 1991

E.E. NUM.	X	Y	Zsup	Zinf/ Talla	ORIENT	PENDENT SECTOR	MATERIA	OBJECTE	LONG	AMPL	ESPE	ALTERACIONS	P D
												OBSERVACIONS	ANY U I N B T U
113	51	0	0	1780	1800		OS	DET	0	0	0	CB RA	1991 S
113	52	0	0	0	1790		OS	DET	0	0	0	AT	1991 S
113	53	0	0	1780	1800		OS	DET	0	0	0		1991 S
113	54	0	0	0	1765	NE	SILEX	BP	0	0	0	LAMINA	1991 S
113	55	0	0	0	1790		OS	DET	0	0	0	1a CST E	1991 S
113	56	0	0	0	1785		OS	DET	0	0	0	CST D	1991 S
113	57	0	0	0	1785		OS	DET	0	0	0	CST E	1991 S
113	58	0	0	0	1790		OS	DET	0	0	0	CL E	1991 S
113	59	0	0	0	1770		OS	DET	0	0	0	FA MA D	1991 S
113	60	0	0	0	1790		CERAMICA	INFORME	0	0	0		1991 S
113	61	0	0	0	1740		OS	DET	0	0	0	VT CE Sup	1991 S
113	62	0	0	1760	1780		OS	INDET	0	0	0		1991 S
113	63	0	0	0	1785		CERAMICA	INFORME	0	0	0		1991 S
113	64	0	0	0	1800	W	CERAMICA	VORA	0	0	0		1991 S
113	65	0	0	0	1760		OS	DET	0	0	0	MC Lat Sup	1991 S
113	66	0	0	0	1770		OS	DET	0	0	0	FA 1,2 Lat Inf	1991 S
113	67	0	0	0	1740		OS	DET	0	0	0	VT F.Inf	1991 S
113	68	0	0	0	1750		OS	DET	0	0	0	CST	1991 S
113	69	0	0	0	1720		OS	DET	0	0	0	CX E	1991 S
113	70	0	0	0	1760		OS	DET	0	0	0	MT PEU E	1991 S
113	71	0	0	0	1760		OS	DET	0	0	0	MT PEU E	1991 S
113	72	0	0	0	1775		OS	DET	0	0	0	FA PEU E F. Sup	1991 S
113	73	0	0	0	1760		OS	DET	0	0	0	MT	1991 S
113	74	0	0	0	1755		OS	DET	0	0	0	T	1991 S
113	75	0	0	0	1760		OS	DET	0	0	0	FRAG E D	1991 S
113	76	0	0	0	1780		CALAITA	DENA	0	0	0	CILINDRICA	1991 S
113	77	0	0	0	1780		CALAITA	DENA	0	0	0	OLIVAR	1991 S
113	78	0	0	0	1790		SILEX	BN2G	0	0	0	LAMINA FASE Ven	1991 S
113	79	0	0	0	1770		CERAMICA	INFORME	0	0	0		1991 S
113	80	0	0	0	1770		CERAMICA	INFORME	0	0	0		1991 S
113	81	0	0	0	1775		OS	DET	0	0	0	MD FASE Sup	1991 S
113	82	0	0	0	1780	V	OS	DET	0	0	0	MOLAR ARREL	1991 S
113	83	0	0	0	1765	V	OS	DET	0	0	0	DENTS MX E	1991 S
113	84	0	0	0	1790		CERAMICA	VORA	0	0	0	SOTA ESCAPULA	1991 S
113	85	0	0	0	1820		CERAMICA	INFORME	0	0	0		1991 S
113	86	0	0	0	12		CERAMICA	VORA	0	0	0	SUPERFICIAL	1991 S
113	87	0	0	0	12		CERAMICA	INFORME	0	0	0	SUPERFICIAL	1991 S
113	88	0	0	0	12		CERAMICA	NANSA	0	0	0	ARRANCAMENT	1991 S
113	89	0	0	0	12		CERAMICA	INFORME	0	0	0	SUPERFICIAL	1991 S
113	90	0	0	0	13	W	CERAMICA	INFORME	0	0	0		1991 S
113	91	0	0	0	14	W	CERAMICA	INFORME	0	0	0		1991 S
113	92	0	0	0	17	W	CERAMICA	INFORME	0	0	0		1991 S
113	93	0	0	0	17	W	CERAMICA	INFORME	0	0	0		1991 S
113	94	0	0	0	17	W	CERAMICA	INFORME	0	0	0	2 FRAGS	1991 S
113	95	0	0	0	18		CERAMICA	INFORME	0	0	0		1991 S
113	96	0	0	0	18		CERAMICA	INFORME	0	0	0		1991 S
113	97	0	0	0	18		CERAMICA	INFORME	0	0	0		1991 S
113	98	0	0	0	16	E	CERAMICA	INFORME	0	0	0		1991 S
113	99	0	0	0	16	W	CERAMICA	INFORME	0	0	0		1991 S
113	100	0	0	0	14	E	SILEX	BPF	0	0	0		1991 S
113	101	0	0	0	15	E	SILEX	BPF	0	0	0		1991 S

BOBILA MADURELL  
MAS DURAN  
campanya 1991

E.E. NUM.	X	Y	Zsup	Zinf/ Talla	ORIENT SECTOR	PENDENT MATERIA	OBJECTE	LONG	AMPL	ESPE	ALTERACIONS	P D
											OBSERVACIONS	ANY U I N B T U
113	102	0	0	0		RMI	BNE	0	0	0	FRAG	1991 S
113	103	0	0	0		OS	INDET	0	0	0	SUPERFICIAL	1991 S
113	104	0	0	0	E	OS	INDET	0	0	0		1991 S
113	105	0	0	0	W	OS	INDET	0	0	0		1991 S
113	106	0	0	0	W	OS	DET	0	0	0		1991 S
113	107	0	0	0	W	OS	DET	0	0	0		1991 S
113	108	0	0	0	E	OS	INDET	0	0	0		1991 S
113	109	0	0	0	W	OS	INDET	0	0	0		1991 S
113	110	0	0	0		OS	DET	0	0	0		1991 S
113	111	0	0	0		OS	DET	0	0	0		1991 S
113	112	0	0	0		OS	DET	0	0	0		1991 S
113	113	0	0	0	W	OS	DET	0	0	0		1991 S
113	114	0	0	0		OS	DET	0	0	0		1991 S
113	115	0	0	0		OS	DET	0	0	0		1991 S
113	116	0	0	0		OS	DET	0	0	0		1991 S
113	117	0	0	0		OS	INDET	0	0	0		1991 S
113	118	0	0	0		OS	INDET	0	0	0		1991 S
113	119	0	0	0		OS	INDET	0	0	0		1991 S
113	120	0	0	0		OS	DET	0	0	0		1991 S
113	121	0	0	0		OS	DET	0	0	0		1991 S
113	122	0	0	0		OS	DET	0	0	0	DENT	1991 S
113	123	0	0	0		OS	DET	0	0	0		1991 S
113	124	0	0	0		OS	DET	0	0	0	CST	1991 S
113	125	0	0	0		OS	BN2G	0	0	0	PUNXO	1991 S
113	126	0	0	0		OS	BN2G	0	0	0	PUNXO	1991 S
113	127	0	0	0	E	ORGANIC	MOLUSC	0	0	0		1991 S
113	128	0	0	0	W	ORGANIC	MOLUSC	0	0	0	FRAG	1991 S
114	1	0	0	0		OS	INDET	0	0	0	VARIS FRAGS	1991 S
114	2	0	0	0		OS	DET	0	0	0		1991 S
114	3	0	0	0		OS	INDET	0	0	0		1991 S
114	4	0	0	0		OS	DET	0	0	0	FA	1991 S
114	5	0	0	0		OS	INDET	0	0	0		1991 S
114	6	0	0	0		OS	INDET	0	0	0		1991 S
114	7	0	0	0		CERAMICA	INFORME	0	0	0		1991 S
114	8	0	0	0		OS	INDET	0	0	0		1991 S
114	9	0	0	0		OS	INDET	0	0	0		1991 S
114	10	0	0	0		OS	INDET	0	0	0		1991 S
114	11	0	0	0		OS	INDET	0	0	0		1991 S
114	12	0	0	0		OS	INDET	0	0	0		1991 S
114	13	0	0	0		OS	INDET	0	0	0		1991 S
114	14	0	0	0		OS	DET	0	0	0		1991 S
114	15	0	0	0		OS	INDET	0	0	0		1991 S
114	16	0	0	0		OS	INDET	0	0	0		1991 S
114	17	0	0	0		OS	INDET	0	0	0		1991 S
114	18	0	0	0		OS	INDET	0	0	0		1991 S
114	19	0	0	0		OS	INDET	0	0	0		1991 S
114	20	0	0	0		CERAMICA	INFORME	0	0	0		1991 S
114	21	0	0	0		CERAMICA	INFORME	0	0	0		1991 S
114	22	0	0	0		OS	INDET	0	0	0		1991 S
114	23	0	0	0		OS	DET	0	0	0		1991 S
114	25	0	0	0		CERAMICA	INFORME	0	0	0		1991 S

BOBILA MADURELL  
MAS DURAN  
campanya 1991

E.E. NUM.	X	Y	Zsup	Zinf/ Talla	ORIENT	PENDENT SECTOR	MATERIA	OBJECTE	LONG	AMPL	ESPE	ALTERACIONS	P D
												OBSERVACIONS	
114	26	0	0	0	1600		SILEX	BP	0	0	0	LAMINA	1991 S
114	27	0	0	0	1610		OS	INDET	0	0	0		1991 S
114	28	0	0	0	1610		OS	DET	0	0	0		1991 S
114	29	0	0	0	1620		SILEX	BP	0	0	0	LAMINA	1991 S
114	30	0	0	0	1660		CERAMICA	VORA	0	0	0		1991 S
114	31	0	0	0	1620		OS	DET	0	0	0		1991 S
114	32	0	0	0	1570		CERAMICA	INFORME	0	0	0		1991 S
114	33	0	0	0	1390		CERAMICA	INFORME	0	0	0		1991 S
114	34	0	0	0	1600		CERAMICA	INFORME	0	0	0		1991 S
114	35	0	0	0	1485		CERAMICA	INFORME	0	0	0		1991 S
114	36	0	0	0	1520		CERAMICA	INFORME	0	0	0		1991 S
114	37	0	0	0	1560		OS	DET	0	0	0		1991 S
114	38	0	0	0	1585		OS	DET	0	0	0	MC	1991 S
114	39	0	0	0	1570		OS	DET	0	0	0	FA 1	1991 S
114	40	0	0	0	1585		OS	DET	0	0	0	FA 3	1991 S
114	41	0	0	0	1610		OS	INDET	0	0	0		1991 S
114	42	0	0	1510	1720		CALCARIA	BNA	0	0	0		1991 S
114	43	0	0	0	1800		OS	INDET	0	0	0		1991 S
114	44	0	0	0	1735		OS	DET	0	0	0	FRAG CST	1991 S
114	45	0	0	0	1735		SILEX	BN2G	0	0	0	TRAPECI	1991 S
114	46	0	0	0	1740		OS	INDET	0	0	0		1991 S
114	47	0	0	0	1770		OS	DET	0	0	0	CREMAT FA 2	1991 S
114	48	0	0	0	1850		SILEX	BP	0	0	0	AMB CORTEX	1991 S
114	49	0	0	0	1835		OS	INDET	0	0	0		1991 S
114	50	0	0	0	1790		SILEX	BN2G	0	0	0	LAMINA	1991 S
114	51	0	0	0	1840		CERAMICA	INFORME	0	0	0	2 FRAGS	1991 S
114	52	0	0	0	1800		SORRENCA	BNA	0	0	0		1991 S
114	53	0	0	0	1800		SORRENCA	BNA	0	0	0		1991 S
114	54	0	0	0	1820		OS	DET	0	0	0		1991 S
114	55	0	0	0	1805		OS	DET	0	0	0	RT	1991 S
114	56	0	0	0	1855		CALCARIA	BNA	0	0	0		1991 S
114	57	0	0	0	1850		OS	DET	0	0	0	CRA BOVID	1991 S
114	58	0	0	0	1820		OS	DET	0	0	0	FE D Dor	1991 S
114	59	0	0	0	1785		OS	DET	0	0	0	TI D Ant	1991 S
114	60	0	0	0	1700		OS	DET	0	0	0	PR D Ant	1991 S
114	61	0	0	0	1630		OS	DET	0	0	0	FA 2 MA E	1991 S
114	62	0	0	0	1835		RMI	BNA	0	0	0		1991 S
114	63	0	0	0	1845		OS	DET	0	0	0	CB E Dor	1991 S
114	64	0	0	0	1845		OS	DET	0	0	0	RA E Dor	1991 S
114	65	0	0	0	1830		CERAMICA	VAS	0	0	0	BOCA QUADRADA	1991 S
114	66	0	0	0	1855		OS	DET	0	0	0	HU D Ant	1991 S
114	67	0	0	0	1855		OS	DET	0	0	0	CB D Dor	1991 S
114	68	0	0	0	1855		OS	DET	0	0	0	RA D Dor	1991 S
114	69	0	0	0	1880		SILEX	BN1G	0	0	0		1991 S
114	70	0	0	0	1840		OS	DET	0	0	0	CL E Inf	1991 S
114	71	0	0	0	1855		SORRENCA	BNA	0	0	0	FRAG	1991 S
114	72	0	0	0	1830		OS	DET	0	0	0	CL	1991 S
114	73	0	0	0	1845		OS	DET	0	0	0	CST D	1991 S
114	74	0	0	0	1865		OS	INDET	0	0	0		1991 S
114	75	0	0	0	1815		OS	DET	0	0	0	FRAG PEL	1991 S
114	76	0	0	0	1840		OS	DET	0	0	0	E D	1991 S

BOBILA MADURELL  
MAS DURAN  
campanya 1991

E.E. NUM.	X	Y	Zsup	Zinf/ Talla	ORIENT	PENDENT SECTOR	MATERIA	OBJECTE	LONG	AMPL	ESPE	ALTERACIONS	P D
												OBSERVACIONS	
114	77	0	0	0	1830		OS	DET	0	0	0	E E	1991 S
114	78	0	0	0	1860		OS	DET	0	0	0	CST E	1991 S
114	79	0	0	0	1850		OS	DET	0	0	0	MPa	1991 S
114	80	0	0	0	1860		OS	DET	0	0	0	VT	1991 S
114	81	0	0	0	1790		OS	DET	0	0	0	PR E Lat Int	1991 S
114	82	0	0	1510	1790		OS	DET	0	0	0	FE E Lat Int	1991 S
114	83	0	0	1550	1750		OS	DET	0	0	0	TI E Lat Int	1991 S
114	84	0	0	0	1730		RMI	BNA	0	0	0		1991 S
114	85	0	0	0	1805		OS	DET	0	0	0	PEL	1991 S
114	86	0	0	0	1715		OS	DET	0	0	0	OSSOS PEU DRET	1991 S
114	87	0	0	0	1240		RMI	BNE	0	0	0	MOLI	1991 S
114	88	0	0	0	1230		OS	DET	0	0	0	MC	1991 S
114	89	0	0	0	1500		OS	DET	0	0	0	FA	1991 S
114	90	0	0	0	186		SILEX	BN2G	0	0	0		1991 S
114	91	0	0	0	1320		RMI	BNA	0	0	0	3 FRAGS	1991 S
114	92	0	0	0	1180		CALCARIA	BNA	0	0	0	FRAG	1991 S
114	93	0	0	0	118		CALCARIA	BNA	0	0	0		1991 S
114	94	0	0	0	1090		OS	DET	0	0	0		1991 S
114	95	0	0	0	1070		CERAMICA	INFORME	0	0	0		1991 S
114	96	0	0	0	1040		OS	INDET	0	0	0		1991 S
114	97	0	0	0	1030		OS	DET	0	0	0	FA 2	1991 S
114	98	0	0	0	980		OS	DET	0	0	0	FA 1	1991 S
114	99	0	0	0	1120		RMI	BNA	0	0	0	FRAG	1991 S
114	100	0	0	0	1000		CERAMICA	INFORME	0	0	0		1991 S
114	101	0	0	0	1010		OS	DET	0	0	0		1991 S
114	102	0	0	0	1010		OS	DET	0	0	0	MC 3	1991 S
114	103	0	0	0	1040		OS	DET	0	0	0	DENT	1991 S
114	104	0	0	0	1040		OS	DET	0	0	0		1991 S
114	105	0	0	0	1050		OS	DET	0	0	0		1991 S
114	107	0	0	0	1140		CALCARIA	BNA	0	0	0		1991 S
114	108	0	0	0	1100		CONGLOME	BNA	0	0	0	FRAG	1991 S
114	109	0	0	0	1190		CONGLOME	BNA	0	0	0		1991 S
114	110	0	0	0	1100		CALCARIA	BNA	0	0	0		1991 S
114	111	0	0	0	1120		RMI	BNA	0	0	0	FRAG	1991 S
114	112	0	0	0	1160		CERAMICA	INFORME	0	0	0		1991 S
114	114	0	0	0	1050		OS	DET	0	0	0	MC 3	1991 S
114	115	0	0	0	1030		OS	DET	0	0	0	MC 3	1991 S
114	116	0	0	0	10	W	CERAMICA	INFORME	0	0	0		1991 S
114	117	0	0	0	11	E	CERAMICA	INFORME	0	0	0		1991 S
114	118	0	0	0	11	W	CERAMICA	INFORME	0	0	0		1991 S
114	119	0	0	0	12	E	CERAMICA	VORA	0	0	0		1991 S
114	120	0	0	0	13	E	CERAMICA	INFORME	0	0	0	VARIS FRAGS	1991 S
114	121	0	0	0	14	E	CERAMICA	INFORME	0	0	0		1991 S
114	122	0	0	0	15	E	CERAMICA	INFORME	0	0	0		1991 S
114	123	0	0	0	16	E	CERAMICA	INFORME	0	0	0		1991 S
114	124	0	0	0	14	E	CERAMICA	INFORME	0	0	0		1991 S
114	125	0	0	0	0		CERAMICA	VORA	0	0	0	VARIS FRAGS	1991 S
114	126	0	0	0	0		CERAMICA	INFORME	0	0	0	VARIS FRAGS	1991 S
114	127	0	0	0	0		CERAMICA	INFORME	0	0	0	VARIS FRAGS	1991 S
114	128	0	0	0	0		CERAMICA	INFORME	0	0	0	VARIS FRAGS	1991 S
114	129	0	0	0	10	E	RMI	BNA	0	0	0	FRAG N.G.	1991 S

BOBILA MADURELL  
MAS DURAN  
campanya 1991

E.E. NUM.	X	Y	Zsup	Zinf/ Talla	ORIENT	PENDENT SECTOR	MATERIA	OBJECTE	LONG	AMPL	ESPE	ALTERACIONS	P D
												OBSERVACIONS	ANY U I N B T U
114	130	0	0	0	10	E	RMI	BNA	0	0	0	FRAG N.G.	1991 S
114	131	0	0	0	10	E	RMI	BNA	0	0	0	FRAG N.G.	1991 S
114	132	0	0	0	10	W	RMI	BNA	0	0	0	N.G.	1991 S
114	133	0	0	0	10	W	QUARS	BNA	0	0	0	N.G.	1991 S
114	134	0	0	0	11	E	RMI	BNA	0	0	0	FRAG N.G.	1991 S
114	135	0	0	0	11	E	RMI	BNA	0	0	0	FRAG N.G.	1991 S
114	136	0	0	0	11	W	CONGLOME	BNA	0	0	0	FRAG N.G.	1991 S
114	137	0	0	0	12	E	CONGLOME	BNA	0	0	0	N.G.	1991 S
114	138	0	0	0	12	W	SORRENCA	BNA	0	0	0	FRAG N.G.	1991 S
114	139	0	0	0	13	W	SORRENCA	BNA	0	0	0	FRAG N.G.	1991 S
114	140	0	0	0	16	E	CALCARIA	BNA	0	0	0	FRAG N.G.	1991 S
114	141	0	0	0	11	W	OS	INDET	0	0	0	CREMAT	1991 S
114	142	0	0	0	11	W	OS	DET	0	0	0		1991 S
114	143	0	0	0	12	W	OS	INDET	0	0	0		1991 S
114	144	0	0	0	12	E	OS	DET	0	0	0		1991 S
114	145	0	0	0	13	E	OS	INDET	0	0	0		1991 S
114	146	0	0	0	17	E	OS	INDET	0	0	0		1991 S
114	147	0	0	0	0		OS	INDET	0	0	0	VARIS FRAGS	1991 S
114	148	0	0	0	0		OS	INDET	0	0	0	VARIS FRAGS	1991 S
115	1	0	0	0	11	E	CERAMICA	VORA	0	0	0		1991 S
115	2	0	0	0	11	E	CERAMICA	INFORME	0	0	0		1991 S
115	3	0	0	0	11	E	CERAMICA	INFORME	0	0	0		1991 S
115	4	0	0	0	11	E	CERAMICA	INFORME	0	0	0		1991 S
115	5	0	0	0	11	E	CERAMICA	INFORME	0	0	0		1991 S
115	6	0	0	0	11	E	CERAMICA	INFORME	0	0	0		1991 S
115	7	0	0	0	11	E	CERAMICA	INFORME	0	0	0		1991 S
115	8	0	0	0	11	E	CERAMICA	INFORME	0	0	0		1991 S
115	9	0	0	0	11	E	CERAMICA	INFORME	0	0	0		1991 S
115	10	0	0	0	11	E	CERAMICA	INFORME	0	0	0		1991 S
115	11	0	0	0	11	E	CERAMICA	INFORME	0	0	0		1991 S
115	12	0	0	0	11	W	CERAMICA	INFORME	0	0	0	FRAG	1991 S
115	13	0	0	0	12	E	CERAMICA	INFORME	0	0	0		1991 S
115	14	0	0	0	12	E	CERAMICA	INFORME	0	0	0		1991 S
115	15	0	0	0	12	E	CERAMICA	INFORME	0	0	0		1991 S
115	16	0	0	0	12	E	CERAMICA	INFORME	0	0	0		1991 S
115	17	0	0	0	12	E	CERAMICA	INFORME	0	0	0		1991 S
115	18	0	0	0	12	E	CERAMICA	INFORME	0	0	0		1991 S
115	19	0	0	0	12	E	CERAMICA	INFORME	0	0	0		1991 S
115	20	0	0	0	12	E	CERAMICA	INFORME	0	0	0		1991 S
115	21	0	0	0	12	E	CERAMICA	INFORME	0	0	0		1991 S
115	22	0	0	0	12	E	CERAMICA	INFORME	0	0	0		1991 S
115	23	0	0	0	12	E	CERAMICA	INFORME	0	0	0		1991 S
115	24	0	0	0	12	E	CERAMICA	INFORME	0	0	0		1991 S
115	25	0	0	0	12	E	TOVOT	FRAG	0	0	0		1991 S
115	26	0	0	0	12	W	CERAMICA	INFORME	0	0	0		1991 S
115	27	0	0	0	12	W	CERAMICA	INFORME	0	0	0		1991 S
115	28	0	0	0	12	W	CERAMICA	INFORME	0	0	0		1991 S
115	29	0	0	0	12	W	CERAMICA	INFORME	0	0	0		1991 S
115	30	0	0	0	12	W	CERAMICA	INFORME	0	0	0	DECORA PLASTICA	1991 S
115	31	0	0	0	12	W	CERAMICA	NANSA	0	0	0	ARRANCAMENT	1991 S
115	32	0	0	0	12	W	CERAMICA	VORA	0	0	0		1991 S

BOBILA MADURELL  
MAS DURAN  
campanya 1991

E.E. NUM.	X	Y	Zsup	Zinf/ Talla	ORIENT	PENDENT SECTOR	MATERIA	OBJECTE	LONG	AMPL	ESPE	ALTERACIONS OBSERVACIONS	P D ANY U I N B T U
115	33	0	0	0	12	W	CERAMICA	INFORME	0	0	0		1991 S
115	34	0	0	0	12	W	CERAMICA	INFORME	0	0	0		1991 S
115	35	0	0	0	12	W	CERAMICA	INFORME	0	0	0		1991 S
115	36	0	0	0	12	W	CERAMICA	INFORME	0	0	0		1991 S
115	37	0	0	0	12	W	CERAMICA	INFORME	0	0	0		1991 S
115	38	0	0	0	12	W	CERAMICA	INFORME	0	0	0		1991 S
115	39	0	0	0	12	W	CERAMICA	VORA	0	0	0		1991 S
115	40	0	0	0	12	W	CERAMICA	INFORME	0	0	0		1991 S
115	41	0	0	0	12	W	CERAMICA	APLICA	0	0	0		1991 S
115	42	0	0	0	13	W	CERAMICA	INFORME	0	0	0		1991 S
115	43	0	0	0	11	E	INDET	BNA	0	0	0	FRAG	1991 S
115	44	0	0	0	11	E	GRANIT	BNA	0	0	0	FRAG	1991 S
115	45	0	0	0	11	E	QUARS	BNA	0	0	0	FRAG	1991 S
115	46	0	0	0	11	E	QUARS	BNA	0	0	0	FRAG N.G.	1991 S
115	47	0	0	0	11	E	RMI	BNA	0	0	0	FRAG N.G.	1991 S
115	48	0	0	0	11	E	RMI	BNA	0	0	0	FRAG	1991 S
115	49	0	0	0	11	E	INDET	BNA	0	0	0	FRAG	1991 S
115	50	0	0	0	11	E	INDET	BNA	0	0	0	FRAG	1991 S
115	51	0	0	0	11	E	INDET	BNA	0	0	0	FRAG N.G.	1991 S
115	52	0	0	0	11	E	RMI	BNA	0	0	0	FRAG	1991 S
115	53	0	0	0	11	E	RMI	BNA	0	0	0	FRAG N.G.	1991 S
115	54	0	0	0	11	W	GRANIT	BNA	0	0	0	FRAG N.G.	1991 S
115	55	0	0	0	11	W	QUARS	BNA	0	0	0	FRAG N.G.	1991 S
115	56	0	0	0	11	W	RMI	BNA	0	0	0	FRAG N.G.	1991 S
115	57	0	0	0	12	E	QUARS	BNA	0	0	0	FRAG N.G.	1991 S
115	58	0	0	0	12	E	RMI	BNA	0	0	0	FRAG N.G.	1991 S
115	59	0	0	0	12	E	RMI	BNA	0	0	0	FRAG N.G.	1991 S
115	60	0	0	0	12	E	RMI	BNA	0	0	0	FRAG	1991 S
115	61	0	0	0	12	E	RMI	BNA	0	0	0	FRAG N.G.	1991 S
115	62	0	0	0	12	E	RMI	BNA	0	0	0	FRAG N.G.	1991 S
115	63	0	0	0	12	E	RMI	BNA	0	0	0	FRAG	1991 S
115	64	0	0	0	12	E	SORRENCA	BNA	0	0	0	FRAG	1991 S
115	65	0	0	0	12	E	RMI	BNA	0	0	0	FRAG N.G.	1991 S
115	66	0	0	0	12	E	RMI	BNA	0	0	0	FRAG N.G.	1991 S
115	67	0	0	0	12	E	RMI	BNA	0	0	0	FRAG N.G.	1991 S
115	68	0	0	0	12	E	RMI	BNA	0	0	0		1991 S
115	69	0	0	0	12	E	INDET	BNA	0	0	0		1991 S
115	70	0	0	0	12	E	RMI	BNA	0	0	0	FRAG N.G.	1991 S
115	71	0	0	0	12	E	RMI	BNA	0	0	0	FRAG N.G.	1991 S
115	72	0	0	0	12	E	RMI	BNA	0	0	0	FRAG N.G.	1991 S
115	73	0	0	0	12	E	INDET	BNA	0	0	0		1991 S
115	74	0	0	0	12	W	RMI	BNA	0	0	0	FRAG N.G.	1991 S
115	75	0	0	0	12	W	RMI	BNA	0	0	0	FRAG N.G.	1991 S
115	76	0	0	0	12	W	RMI	BNA	0	0	0	FRAG	1991 S
115	77	0	0	0	12	W	RMI	BNA	0	0	0	FRAG N.G.	1991 S
115	78	0	0	0	12	W	INDET	BNA	0	0	0	FRAG N.G.	1991 S
115	79	0	0	0	12	W	RMI	BNA	0	0	0	FRAG N.G.	1991 S
115	80	0	0	0	12	W	CALCARIA	BNA	0	0	0	FRAG	1991 S
115	81	0	0	0	12	W	INDET	BNA	0	0	0	N.G.	1991 S
115	82	0	0	0	12	W	SORRENCA	BNA	0	0	0		1991 S
115	83	0	0	0	12	W	QUARS	BNA	0	0	0	FRAG N.G.	1991 S

BOBILA MADURELL  
MAS DURAN  
campanya 1991

E.E. NUM.	X	Y	Zsup	Zinf/ Talla	ORIENT	PENDENT SECTOR	MATERIA	OBJECTE	LONG	AMPL	ESPE	ALTERACIONS	P D
												OBSERVACIONS	ANY U I N B T U
115	84	0	0	0	12	W	RMI	BNA	0	0	0	FRAG N.G.	1991 S
115	85	0	0	0	12	W	RMI	BNA	0	0	0	FRAG N.G.	1991 S
115	86	0	0	0	12	W	CONGLOME	BNA	0	0	0	FRAG	1991 S
115	87	0	0	0	12	W	RMI	BNA	0	0	0		1991 S
115	88	0	0	0	12	W	RMI	BNA	0	0	0	FRAG N.G.	1991 S
115	89	0	0	0	12	W	RMI	BNA	0	0	0	FRAG N.G.	1991 S
115	90	0	0	0	12	W	RMI	BNA	0	0	0	FRAG N.G.	1991 S
115	91	0	0	0	12	W	RMI	BNA	0	0	0	FRAG N.G.	1991 S
115	92	0	0	0	12	W	RMI	BNA	0	0	0	FRAG N.G.	1991 S
115	93	0	0	0	12	W	QUARS	BNA	0	0	0	FRAG N.G.	1991 S
115	94	0	0	0	12	W	RMI	BNA	0	0	0	FRAG N.G.	1991 S
115	95	0	0	0	12	W	QUARS	BNA	0	0	0	FRAG N.G.	1991 S
115	96	0	0	0	12	W	RMI	BNA	0	0	0	FRAG N.G.	1991 S
115	97	0	0	0	12	W	RMI	BNA	0	0	0	FRAG N.G.	1991 S
115	98	0	0	0	12	W	RMI	BNA	0	0	0	FRAG N.G.	1991 S
115	99	0	0	0	12	W	RMI	BNA	0	0	0	FRAG N.G.	1991 S
115	100	0	0	0	13	E	SORRENCA	BNA	0	0	0	ALTERAT?	1991 S
115	101	0	0	0	13	E	QUARS	BNA	0	0	0	FRAG N.G.	1991 S
115	102	0	0	0	12	E	RMI	BNA	0	0	0	FRAG N.G.	1991 S
115	103	0	0	0	12	E	SORRENCA	BNA	0	0	0	FRAG	1991 S
115	104	0	0	0	12	E	GRANIT	BNA	0	0	0	FRAG N.G.	1991 S
115	105	0	0	0	12	W	RMI	BNA	0	0	0	FRAG N.G.	1991 S
115	106	0	0	0	12	W	RMI	BNA	0	0	0	N.G.	1991 S
115	107	0	0	0	12	W	RMI	BNA	0	0	0	FRAG N.G.	1991 S
115	108	0	0	0	12	W	RMI	BNA	0	0	0	FRAG	1991 S
115	109	0	0	0	12	W	RMI	BNE	0	0	0	FRAG MOLI	1991 S
115	110	0	0	0	13	E	RMI	BNA	0	0	0	FRAG N.G.	1991 S
115	111	0	0	0	13	E	RMI	BNA	0	0	0	FRAG N.G.	1991 S
115	112	0	0	0	13	E	RMI	BNA	0	0	0	FRAG N.G.	1991 S
115	113	0	0	0	13	E	INDET	BNA	0	0	0	FRAG N.G.	1991 S
115	114	0	0	0	13	E	RMI	BNA	0	0	0		1991 S
115	115	0	0	0	13	E	RMI	BNA	0	0	0	FRAG N.G.	1991 S
115	116	0	0	0	13	E	RMI	BNA	0	0	0	FRAG N.G.	1991 S
115	117	0	0	0	13	E	SORRENCA	BNA	0	0	0	FRAG N.G.	1991 S
115	118	0	0	0	13	E	RMI	BNA	0	0	0	FRAG N.G.	1991 S
115	119	0	0	0	13	E	QUARS	BNA	0	0	0	FRAG N.G.	1991 S
115	120	0	0	0	13	E	RMI	BNA	0	0	0	FRAG N.G.	1991 S
115	121	0	0	0	13	E	GRANIT	BNA	0	0	0	FRAG N.G.	1991 S
115	122	0	0	0	13	E	GRANIT	BNA	0	0	0	FRAG N.G.	1991 S
115	123	0	0	0	13	E	CALCARIA	BNA	0	0	0	N.G.	1991 S
115	124	0	0	0	13	E	RMI	BNA	0	0	0	FRAG N.G.	1991 S
115	125	0	0	0	13	E	RMI	BNA	0	0	0	FRAG N.G.	1991 S
115	126	0	0	0	13	E	CONGLOME	BNA	0	0	0	FRAG N.G.	1991 S
115	127	0	0	0	13	E	RMI	BNA	0	0	0	FRAG N.G.	1991 S
115	128	0	0	0	13	W	CALCARIA	BNA	0	0	0	FRAG N.G.	1991 S
115	129	0	0	0	13	W	SORRENCA	BNA	0	0	0	FRAG N.G.	1991 S
115	130	0	0	0	13	W	RMI	BNA	0	0	0	FRAG N.G.	1991 S
115	131	0	0	0	13	W	RMI	BNA	0	0	0	FRAG N.G.	1991 S
115	132	0	0	0	13	W	RMI	BNA	0	0	0	FRAG N.G.	1991 S
115	133	0	0	0	13	E	ESQUIST	BNA	0	0	0	FRAG	1991 S
115	134	0	0	0	13	W	RMI	BNA	0	0	0	FRAG N.G.	1991 S



BOBILA MADURELL  
MAS DURAN  
campanya 1991

E.E. NUM.	X	Y	Zsup	Zinf/ Talla	ORIENT	PENDENT SECTOR	MATERIA	OBJECTE	LONG	AMPL	ESPE	ALTERACIONS	P D
												OBSERVACIONS	
115	135	0	0	0	13	E	RMI	BNA	0	0	0	FRAG N.G.	1991 S
115	136	0	0	0	13	E	SORRENCA	BNA	0	0	0	FRAG N.G.	1991 S
115	137	0	0	0	13	W	SORRENCA	BNA	0	0	0	FRAG N.G.	1991 S
115	138	0	0	0	13	E	QUARS	BNA	0	0	0	FRAG N.G.	1991 S
115	139	0	0	0	13	E	CERAMICA	INFORME	0	0	0		1991 S
115	140	0	0	0	11	E	OS	INDET	0	0	0		1991 S
115	141	0	0	0	12	W	OS	DET	0	0	0	DENT OCND	1991 S
115	142	0	0	0	12	W	OS	DET	0	0	0	DET?	1991 S
115	143	0	0	0	12	W	OS	INDET	0	0	0		1991 S
115	144	0	0	0	12	W	OS	DET	0	0	0	CREMAT	1991 S
115	145	0	0	0	12	W	OS	INDET	0	0	0		1991 S
115	146	0	0	0	12	W	OS	INDET	0	0	0		1991 S
115	147	0	0	0	12	W	OS	INDET	0	0	0		1991 S
115	148	0	0	0	13	E	OS	INDET	0	0	0		1991 S
115	149	0	0	0	13	W	OS	DET	0	0	0	DET?	1991 S
502	1	0	0	8	8	N	CERAMICA	INFORME	0	0	0		1991 S
502	2	0	0	8	8	N	CERAMICA	INFORME	0	0	0		1991 S
502	3	0	0	8	8	N	CERAMICA	INFORME	0	0	0		1991 S
502	4	0	0	8	8	N	CERAMICA	INFORME	0	0	0	VARIS FRAGS	1991 S
502	5	0	0	9	9	N	CERAMICA	INFORME	0	0	0		1991 S
502	6	0	0	10	10	N	CERAMICA	INFORME	0	0	0		1991 S
502	7	0	0	11	11	N	CERAMICA	INFORME	0	0	0	VARIS FRAGS	1991 S
502	8	0	0	12	12	N	CERAMICA	INFORME	0	0	0	3 FRAGS	1991 S
502	9	0	0	9	9	N	SILEX	BP2G	0	0	0		1991 S
502	10	0	0	6	6	N	RMI	BNA	0	0	0	FRAG	1991 S
502	11	0	0	8	8	N	SORRENCA	BNA	0	0	0		1991 S
502	12	0	0	8	8	N	CALCARIA	BNE	0	0	0		1991 S
502	13	0	0	8	8	N	CONGLOME	BNE	0	0	0	MOLI DE MA	1991 S
502	14	0	0	10	10	N	SORRENCA	BNA	0	0	0		1991 S
502	15	0	0	11	11	N	CALCARIA	BNA	0	0	0		1991 S
502	16	0	0	8	8	N	OS	INDET	0	0	0		1991 S
502	17	0	0	8	8	N	OS	DET	0	0	0	VARIS FRAGS	1991 S
502	18	0	0	11	11	N	OS	DET	0	0	0	VARIS FRAGS	1991 S
7-1	1	0	0	0	12		RMI	BNA	0	0	0	FRAG	1991 S
7-1	2	0	0	0	12		QUARS	BNA	0	0	0		1991 S
7-1	3	0	0	0	12		RMI	BNA	0	0	0	FRAC	1991 S
7-1	4	0	0	0	12		RMI	BNA	0	0	0	FRAC	1991 S
7-1	5	0	0	0	12		RMI	BNA	0	0	0	FRAG	1991 S
7-1	6	0	0	0	12		GRANIT	BNA	0	0	0	FRAG	1991 S
7-1	7	0	0	0	12		RMI	BNA	0	0	0	FRAG	1991 S
7-1	8	0	0	0	12		RMI	BNA	0	0	0	FRAG	1991 S
7-1	9	0	0	0	12		GRANIT	BNA	0	0	0	FRAG	1991 S
7-1	10	0	0	0	12		GRANIT	BNA	0	0	0	FRAC	1991 S
7-1	11	0	0	0	12		RMI	BNA	0	0	0	FRAG	1991 S
7-1	12	0	0	0	12		RMI	BNA	0	0	0	FRAG	1991 S
7-1	13	0	0	0	12		ESQUIST	BNA	0	0	0	FRAG	1991 S
7-1	14	0	0	0	12		GRANIT	BNA	0	0	0		1991 S
7-1	15	0	0	0	12		RMI	BNA	0	0	0	FRAG	1991 S
7-1	16	0	0	0	12		RMI	BNA	0	0	0	FRAG	1991 S
7-1	17	0	0	0	12		RMI	BNA	0	0	0		1991 S
7-1	18	0	0	0	12		RMI	BNA	0	0	0	FRAG	1991 S

BOBILA MADURELL  
MAS DURAN  
campanya 1991

E.E. NUM.	X	Y	Zsup	Zinf/ Talla	ORIENT	PENDENT SECTOR	MATERIA	OBJECTE	LONG	AMPL	ESPE	ALTERACIONS	P D
												OBSERVACIONS	ANY U I N B T U
7-1	19	0	0	0	12		RMI	BNA	0	0	0	FRAG	1991 S
7-1	20	0	0	0	12		GRANIT	BNA	0	0	0	FRAG	1991 S
7-1	21	0	0	0	12		QUARS	BNA	0	0	0	FRAG	1991 S
7-1	22	0	0	0	12		CALCARIA	BNA	0	0	0	FRAG CREMAT	1991 S
7-1	23	0	0	0	12		QUARS	BNA	0	0	0	FRAG	1991 S
7-1	24	0	0	0	12		CALCARIA	BNA	0	0	0	CREMAT	1991 S
7-1	25	0	0	0	12		CALCARIA	BNA	0	0	0	CREMAT	1991 S
7-1	26	0	0	0	12	NW	RMI	BNA	0	0	0	FRAG	1991 S
7-1	27	0	0	0	12	NW	GRANIT	BNA	0	0	0	FRAC	1991 S
7-1	28	0	0	0	12	NW	RMI	BNA	0	0	0	FRAG	1991 S
7-1	29	0	0	0	12	NW	QUARS	BNA	0	0	0	FRAG	1991 S
7-1	30	0	0	0	12	NW	CALCARIA	BNA	0	0	0		1991 S
7-1	31	0	0	0	12	NW	RMI	BNA	0	0	0	FRAG	1991 S
7-1	32	0	0	0	12	NW	RMI	BNA	0	0	0		1991 S
7-1	33	0	0	0	12	NW	QUARS	BNA	0	0	0	FRAG	1991 S
7-1	34	0	0	0	12	NW	RMI	BNA	0	0	0		1991 S
7-1	35	0	0	0	12	NW	QUARS	BNA	0	0	0		1991 S
7-1	36	0	0	0	12	NW	RMI	BNA	0	0	0	FRAC	1991 S
7-1	37	0	0	0	12	NW	RMI	BNA	0	0	0	FRAG	1991 S
7-1	38	0	0	0	12	NW	QUARS	BNA	0	0	0	FRAG	1991 S
7-1	39	0	0	0	12	NW	RMI	BNA	0	0	0		1991 S
7-1	40	0	0	0	12	NW	RMI	BNA	0	0	0	FRAG	1991 S
7-1	41	0	0	0	12	NW	RMI	BNA	0	0	0	FRAG	1991 S
7-1	42	0	0	0	12	NW	RMI	BNA	0	0	0	FRAG	1991 S
7-1	43	0	0	0	12	NW	RMI	BNA	0	0	0		1991 S
7-1	44	0	0	0	12	NW	CALCARIA	BNA	0	0	0		1991 S
7-1	45	0	0	0	12	NW	RMI	BNA	0	0	0	FRAG	1991 S
7-1	46	0	0	0	12	NW	RMI	BNA	0	0	0	FRAG	1991 S
7-1	47	0	0	0	12	NW	RMI	BNA	0	0	0	FRAG	1991 S
7-1	48	0	0	0	12	SW	RMI	BNA	0	0	0	FRAG	1991 S
7-1	49	0	0	0	12	SW	RMI	BNA	0	0	0	FRAG	1991 S
7-1	50	0	0	0	12	SW	QUARS	BNA	0	0	0		1991 S
7-1	51	0	0	0	12	SW	QUARS	BNA	0	0	0		1991 S
7-1	52	0	0	0	12	SW	GRANIT	BNA	0	0	0	FRAG	1991 S
7-1	53	0	0	0	12	SW	RMI	BNA	0	0	0	FRAG	1991 S
7-1	54	0	0	0	12	NW	QUARS	BNA	0	0	0	FRAG	1991 S
7-1	55	0	0	0	12	NW	QUARS	BNA	0	0	0	FRAG	1991 S
7-1	56	0	0	0	12	NW	QUARS	BNA	0	0	0	FRAG	1991 S
7-1	57	0	0	0	12		RMI	BNA	0	0	0	FRAG	1991 S
7-1	58	0	0	0	13		RMI	BNA	0	0	0	FRAC	1991 S
7-1	59	0	0	0	13		RMI	BNA	0	0	0	FRAG	1991 S
7-1	60	0	0	0	13		RMI	BNA	0	0	0	FRAG	1991 S
7-1	61	0	0	0	13		QUARS	BNA	0	0	0	FRAG	1991 S
7-1	62	0	0	0	13		ESQUIST	PLAQUETA	0	0	0	FRAG	1991 S
7-1	63	0	0	0	13		QUARS	BNA	0	0	0	FRAG	1991 S
7-1	64	0	0	0	13	NW	QUARS	BNA	0	0	0	FRAG	1991 S
7-1	65	0	0	0	13	NW	RMI	BNA	0	0	0	FRAG	1991 S
7-1	66	0	0	0	13	NW	RMI	BNA	0	0	0	FRAG	1991 S
7-1	67	0	0	0	13	NW	RMI	BNA	0	0	0	FRAG	1991 S
7-1	68	0	0	0	13	NW	RMI	BNA	0	0	0	FRAG	1991 S
7-1	69	0	0	0	13	NW	QUARS	BNA	0	0	0	FRAG	1991 S

1997-1

BOBILA MADURELL  
MAS DURAN  
campanya 1991

E.E. NUM.	X	Y	Zsup	Zinf/ Talla	ORIENT	PENDENT SECTOR	MATERIA	OBJECTE	LONG	AMPL	ESPE	ALTERACIONS	P D
												OBSERVACIONS	ANY U I N B T U
7-1	70	0	0	0	13	NW	RMI	BNA	0	0	0	FRAG	1991 S
7-1	71	0	0	0	13	NW	RMI	BNA	0	0	0	FRAG	1991 S
7-1	72	0	0	0	13	NW	RMI	BNA	0	0	0	FRAG	1991 S
7-1	73	0	0	0	13	NW	CALCARIA	BNA	0	0	0		1991 S
7-1	74	0	0	0	13	NW	ESQUIST	BNA	0	0	0	FRAG	1991 S
7-1	75	0	0	0	13	NW	GRANIT	BNA	0	0	0	FRAG	1991 S
7-1	76	0	0	0	13	SW	QUARS	BNA	0	0	0	FRAG	1991 S
7-1	77	0	0	0	14	E	QUARS	BNA	0	0	0		1991 S
7-1	78	0	0	0	12	SW	RMI	BNA	0	0	0	FRAG	1991 S
7-1	79	0	0	0	12	SW	RMI	BNA	0	0	0	FRAG	1991 S
7-1	80	0	0	0	12	SW	QUARS	BNA	0	0	0	FRAG	1991 S
7-1	81	0	0	0	12	SW	QUARS	BNA	0	0	0	FRAG	1991 S
7-1	82	0	0	0	12	SW	GRANIT	BNA	0	0	0		1991 S
7-1	83	0	0	0	12	SW	QUARS	BNA	0	0	0	FRAG	1991 S
7-1	84	0	0	0	13	SW	QUARS	BNA	0	0	0	FRAG	1991 S
7-1	85	0	0	0	13	SW	RMI	BNA	0	0	0	FRAG	1991 S
7-1	86	0	0	0	13	SW	CALCARIA	BNA	0	0	0	FRAG	1991 S
7-1	87	0	0	0	13	SW	QUARS	BNA	0	0	0	FRAG	1991 S
7-1	88	0	0	0	13		RMI	BNA	0	0	0	FRAG	1991 S
7-1	89	0	0	0	12		SILEX	BP2G	0	0	0		1991 S
7-1	90	0	0	0	12		SORRENCA	BNA	0	0	0		1991 S
7-2	1	0	0	0	5		CERAMICA	INFORME	0	0	0	SUPERFICIAL	1991 S
7-2	2	0	0	0	5		CERAMICA	INFORME	0	0	0	SUPERFICIAL	1991 S
7-2	3	0	0	0	5		CERAMICA	INFORME	0	0	0	SUPERFICIAL	1991 S
7-2	4	0	0	0	5		CERAMICA	INFORME	0	0	0	SUPERFICIAL	1991 S
7-2	5	0	0	0	5		CERAMICA	INFORME	0	0	0	SUPERFICIAL	1991 S
7-2	6	0	0	0	5		CERAMICA	INFORME	0	0	0	SUPERFICIAL	1991 S
7-2	7	0	0	0	5		CERAMICA	INFORME	0	0	0	SUPERFICIAL	1991 S
7-2	8	0	0	0	5		CERAMICA	INFORME	0	0	0	SUPERFICIAL	1991 S
7-2	9	0	0	0	5		CERAMICA	INFORME	0	0	0	SUPERFICIAL	1991 S
7-2	10	0	0	0	5		CERAMICA	INFORME	0	0	0	SUPERFICIAL	1991 S
7-2	11	0	0	0	5		CERAMICA	INFORME	0	0	0	SUPERFICIAL	1991 S
7-2	12	0	0	0	5		CERAMICA	INFORME	0	0	0	SUPERFICIAL	1991 S
7-2	13	0	0	0	5		CERAMICA	INFORME	0	0	0	SUPERFICIAL	1991 S
7-2	14	0	0	0	5		CERAMICA	VORA	0	0	0	SUPERFICIAL	1991 S
7-2	15	0	0	0	5		CERAMICA	INFORME	0	0	0	SUPERFICIAL	1991 S
7-2	16	0	0	0	5		CERAMICA	INFORME	0	0	0	SUPERFICIAL	1991 S
7-2	17	0	0	0	5		CERAMICA	INFORME	0	0	0	SUPERFICIAL	1991 S
7-2	18	0	0	0	6	E	CERAMICA	INFORME	0	0	0	3 FRAGS	1991 S
7-2	19	0	0	0	6	E	CERAMICA	INFORME	0	0	0		1991 S
7-2	20	0	0	0	6	E	CERAMICA	VORA	0	0	0		1991 S
7-2	21	0	0	0	6	E	CERAMICA	INFORME	0	0	0		1991 S
7-2	22	0	0	0	6	E	CERAMICA	INFORME	0	0	0		1991 S
7-2	23	0	0	0	6	E	CERAMICA	INFORME	0	0	0		1991 S
7-2	24	0	0	0	6	E	CERAMICA	VORA	0	0	0		1991 S
7-2	25	0	0	0	6	W	CERAMICA	PANXA	0	0	0		1991 S
7-2	26	0	0	0	6	W	CERAMICA	PANXA	0	0	0	VARIS FRAGS	1991 S
7-2	27	0	0	0	6	W	CERAMICA	NANSA	0	0	0		1991 S
7-2	28	0	0	0	6	W	CERAMICA	CARENA	0	0	0	VARIS FRAGS	1991 S
7-2	29	0	0	0	6	W	CERAMICA	PANXA	0	0	0		1991 S
7-2	30	0	0	0	6	W	CERAMICA	PANXA	0	0	0		1991 S

BOBILA MADURELL  
MAS DURAN  
campanya 1991

E.E. NUM.	X	Y	Zsup	Zinf/ Talla	ORIENT	PENDENT SECTOR	MATERIA	OBJECTE	LONG	AMPL	ESPE	ALTERACIONS OBSERVACIONS	P D			
													ANY	U	I	N B
													T	U		
7-2	31	0	0	0	6	W	CERAMICA	PANXA	0	0	0	3 FRAGS	1991	S		
7-2	32	0	0	0	6	W	CERAMICA	INFORME	0	0	0		1991	S		
7-2	33	0	0	0	6	W	CERAMICA	INFORME	0	0	0		1991	S		
7-2	34	0	0	0	6	W	CERAMICA	INFORME	0	0	0		1991	S		
7-2	35	0	0	0	6	W	CERAMICA	INFORME	0	0	0		1991	S		
7-2	36	0	0	0	6	W	CERAMICA	INFORME	0	0	0	2 FRAGS	1991	S		
7-2	37	0	0	0	7	W	CERAMICA	INFORME	0	0	0	VARIS FRAGS	1991	S		
7-2	38	0	0	0	7	W	CERAMICA	INFORME	0	0	0	DECOR INTERNA	1991	S		
7-2	39	0	0	0	7	W	CERAMICA	INFORME	0	0	0	VARIS FRAGS	1991	S		
7-2	40	0	0	0	8	W	CERAMICA	INFORME	0	0	0		1991	S		
7-2	41	0	0	0	8	W	CERAMICA	INFORME	0	0	0		1991	S		
7-2	42	0	0	0	6	W	SILEX	BP	0	0	0		1991	S		
7-2	43	0	0	0	7	W	QUARS	BPI	0	0	0		1991	S		
7-2	44	0	0	0	7	W	SORRENCA	BNA	0	0	0		1991	S		
7-2	45	0	0	0	6	W	OS	INDET	0	0	0	FRAGS CREMAT	1991	S		
7-2	46	0	0	0	7	W	OS	DET	0	0	0	CREMAT	1991	S		
7-2	47	0	0	0	7	W	OS	INDET	0	0	0	2 FRAGS CREMAT	1991	S		
7-2	48	0	0	0	8	W	OS	INDET	0	0	0	2 FRAGS CREMAT	1991	S		
7-2	50	0	0	0	6	W	CERAMICA	PANXA	0	0	0	2 FRAGS	1991	S		
7-2	51	0	0	0	6	W	CERAMICA	PANXA	0	0	0	4 FRAGS	1991	S		
7-2	52	0	0	0	6	W	CERAMICA	INFORME	0	0	0		1991	S		
7-2	53	0	0	0	6	W	CERAMICA	INFORME	0	0	0		1991	S		
7-2	54	0	0	0	6	W	CERAMICA	INFORME	0	0	0		1991	S		
7-2	55	0	0	0	6	W	CERAMICA	INFORME	0	0	0		1991	S		
7-2	56	0	0	0	6	E	OS	DET	0	0	0		1991	S		
7-2	57	0	0	0	7	W	OS	INDET	0	0	0	CREMAT	1991	S		
7-2	58	0	0	0	7	W	OS	INDET	0	0	0	CREMAT	1991	S		
7-2	59	0	0	0	7	W	OS	INDET	0	0	0	CREMAT	1991	S		
7-3	1	0	0	0	6	E	CERAMICA	INFORME	0	0	0		1991	S		
7-3	2	0	0	0	6	E	CERAMICA	INFORME	0	0	0		1991	S		
7-3	3	0	0	0	6	E	CERAMICA	NANSA	0	0	0		1991	S		
7-3	4	0	0	0	6	E	CERAMICA	VORA	0	0	0		1991	S		
7-3	5	0	0	0	6	E	CERAMICA	INFORME	0	0	0		1991	S		
7-3	6	0	0	0	6	E	CERAMICA	INFORME	0	0	0		1991	S		
7-3	7	0	0	0	6	E	CERAMICA	INFORME	0	0	0	VARIS FRAGS	1991	S		
7-3	8	0	0	0	6	E	CERAMICA	INFORME	0	0	0	VARIS FRAGS	1991	S		
7-3	9	0	0	0	6	E	CERAMICA	INFORME	0	0	0	INCIS CARA INT	1991	S		
7-3	10	0	0	0	6	E	CERAMICA	INFORME	0	0	0		1991	S		
7-3	11	0	0	0	6	W	CERAMICA	INFORME	0	0	0		1991	S		
7-3	12	0	0	0	6	W	CERAMICA	VORA	0	0	0	DECOR INCISIONS	1991	S		
7-3	13	0	0	0	6	W	CERAMICA	INFORME	0	0	0		1991	S		
7-3	14	0	0	0	6	W	CERAMICA	INFORME	0	0	0	FRAG	1991	S		
7-3	15	0	0	0	6	W	CERAMICA	INFORME	0	0	0		1991	S		
7-3	16	0	0	0	6	W	CERAMICA	INFORME	0	0	0		1991	S		
7-3	17	0	0	0	6	W	CERAMICA	INFORME	0	0	0		1991	S		
7-3	18	0	0	0	7	E	CERAMICA	INFORME	0	0	0		1991	S		
7-3	19	0	0	0	7	E	CERAMICA	INFORME	0	0	0		1991	S		
7-3	20	0	0	0	7	E	CERAMICA	INFORME	0	0	0		1991	S		
7-3	21	0	0	0	7	E	CERAMICA	INFORME	0	0	0		1991	S		
7-3	22	0	0	0	7	E	CERAMICA	INFORME	0	0	0		1991	S		
7-3	23	0	0	0	7	E	CERAMICA	INFORME	0	0	0		1991	S		

BOBILA MADURELL  
MAS DURAN  
campanya 1991

E.E. NUM.	X	Y	Zsup	Zinf/ Talla	ORIENT	PENDENT SECTOR	MATERIA	OBJECTE	LONG	AMPL	ESPE	ALTERACIONS	P D
												OBSERVACIONS	ANY U I N B T U
7-3	24	0	0	0	7	E	CERAMICA	INFORME	0	0	0	2 FRAGS	1991 S
7-3	25	0	0	0	7	E	CERAMICA	INFORME	0	0	0		1991 S
7-3	26	0	0	0	7	E	CERAMICA	INFORME	0	0	0		1991 S
7-3	27	0	0	0	7	E	CERAMICA	INFORME	0	0	0		1991 S
7-3	28	0	0	0	7	E	CERAMICA	INFORME	0	0	0		1991 S
7-3	29	0	0	0	7	E	CERAMICA	INFORME	0	0	0		1991 S
7-3	30	0	0	0	7	E	CERAMICA	INFORME	0	0	0	2 FRAGS	1991 S
7-3	31	0	0	0	7	E	CERAMICA	INFORME	0	0	0		1991 S
7-3	32	0	0	0	7	E	CERAMICA	INFORME	0	0	0		1991 S
7-3	33	0	0	0	7	E	CERAMICA	INFORME	0	0	0		1991 S
7-3	34	0	0	0	7	E	CERAMICA	INFORME	0	0	0		1991 S
7-3	35	0	0	0	7	E	CERAMICA	INFORME	0	0	0		1991 S
7-3	36	0	0	0	7	E	CERAMICA	INFORME	0	0	0		1991 S
7-3	37	0	0	0	7	E	CERAMICA	INFORME	0	0	0		1991 S
7-3	38	0	0	0	7	E	CERAMICA	INFORME	0	0	0		1991 S
7-3	39	0	0	0	7	E	CERAMICA	INFORME	0	0	0		1991 S
7-3	40	0	0	0	7	E	CERAMICA	INFORME	0	0	0		1991 S
7-3	41	0	0	0	7	E	CERAMICA	INFORME	0	0	0		1991 S
7-3	42	0	0	0	7	E	CERAMICA	INFORME	0	0	0		1991 S
7-3	43	0	0	0	7	E	CERAMICA	INFORME	0	0	0		1991 S
7-3	44	0	0	0	7	E	CERAMICA	INFORME	0	0	0		1991 S
7-3	45	0	0	0	7	E	CERAMICA	INFORME	0	0	0		1991 S
7-3	46	0	0	0	7	E	CERAMICA	INFORME	0	0	0		1991 S
7-3	47	0	0	0	7	E	CERAMICA	INFORME	0	0	0		1991 S
7-3	48	0	0	0	7	E	CERAMICA	CARENA	0	0	0		1991 S
7-3	49	0	0	0	7	E	CERAMICA	INFORME	0	0	0		1991 S
7-3	50	0	0	0	7	E	CERAMICA	INFORME	0	0	0		1991 S
7-3	51	0	0	0	7	E	CERAMICA	INFORME	0	0	0		1991 S
7-3	52	0	0	0	7	E	CERAMICA	INFORME	0	0	0		1991 S
7-3	53	0	0	0	7	E	CERAMICA	INFORME	0	0	0		1991 S
7-3	54	0	0	0	7	E	CERAMICA	INFORME	0	0	0		1991 S
7-3	55	0	0	0	7	E	CERAMICA	INFORME	0	0	0		1991 S
7-3	56	0	0	0	7	E	CERAMICA	INFORME	0	0	0		1991 S
7-3	57	0	0	0	7	E	CERAMICA	INFORME	0	0	0		1991 S
7-3	58	0	0	0	7	E	CERAMICA	INFORME	0	0	0		1991 S
7-3	59	0	0	0	7	E	CERAMICA	INFORME	0	0	0		1991 S
7-3	60	0	0	0	7	E	CERAMICA	INFORME	0	0	0		1991 S
7-3	61	0	0	0	7	E	CERAMICA	INFORME	0	0	0		1991 S
7-3	62	0	0	0	7	E	CERAMICA	INFORME	0	0	0		1991 S
7-3	63	0	0	0	7	E	CERAMICA	INFORME	0	0	0		1991 S
7-3	64	0	0	0	7	E	CERAMICA	PANXA	0	0	0		1991 S
7-3	65	0	0	0	7	E	CERAMICA	INFORME	0	0	0		1991 S
7-3	66	0	0	0	7	E	CERAMICA	VORA	0	0	0		1991 S
7-3	67	0	0	0	7	E	CERAMICA	PANXA	0	0	0		1991 S
7-3	68	0	0	0	7	E	CERAMICA	INFORME	0	0	0		1991 S
7-3	69	0	0	0	7	E	CERAMICA	INFORME	0	0	0		1991 S
7-3	70	0	0	0	7	E	CERAMICA	INFORME	0	0	0		1991 S
7-3	71	0	0	0	7	E	CERAMICA	INFORME	0	0	0		1991 S
7-3	72	0	0	0	7	E	CERAMICA	INFORME	0	0	0		1991 S
7-3	73	0	0	0	7	E	CERAMICA	INFORME	0	0	0		1991 S
7-3	74	0	0	0	7	E	CERAMICA	INFORME	0	0	0		1991 S

BOBILA MADURELL  
MAS DURAN  
campanya 1991

E.E. NUM.	X	Y	Zsup	Zinf/ Talla	ORIENT	PENDENT SECTOR	MATERIA	OBJECTE	LONG	AMPL	ESPE	ALTERACIONS	P D
												OBSERVACIONS	ANY U I N B T U
7-3	75	0	0	0	7	E	CERAMICA	INFORME	0	0	0		1991 S
7-3	76	0	0	0	7	E	CERAMICA	CARENA	0	0	0		1991 S
7-3	77	0	0	0	7	E	CERAMICA	NANSA	0	0	0	ARRANCADA	1991 S
7-3	78	0	0	0	7	E	CERAMICA	CARENA	0	0	0		1991 S
7-3	79	0	0	0	7	E	CERAMICA	PANXA	0	0	0	3 FRAGS	1991 S
7-3	80	0	0	0	7	E	CERAMICA	PANXA	0	0	0	VARIS FRAGS	1991 S
7-3	81	0	0	0	7	E	CERAMICA	INFORME	0	0	0		1991 S
7-3	82	0	0	0	7	E	CERAMICA	INFORME	0	0	0	VARIS FRAGS	1991 S
7-3	83	0	0	0	7	E	CERAMICA	INFORME	0	0	0		1991 S
7-3	84	0	0	0	7	E	CERAMICA	INFORME	0	0	0		1991 S
7-3	85	0	0	0	7	E	CERAMICA	PANXA	0	0	0	DECO FORMA OVAL	1991 S
7-3	86	0	0	0	7	E	CERAMICA	INFORME	0	0	0		1991 S
7-3	87	0	0	0	7	E	CERAMICA	INFORME	0	0	0		1991 S
7-3	88	0	0	0	7	E	CERAMICA	INFORME	0	0	0		1991 S
7-3	89	0	0	0	7	E	CERAMICA	VORA	0	0	0		1991 S
7-3	90	0	0	0	7	E	CERAMICA	INFORME	0	0	0		1991 S
7-3	91	0	0	0	7	E	CERAMICA	INFORME	0	0	0		1991 S
7-3	92	0	0	0	7	E	CERAMICA	INFORME	0	0	0		1991 S
7-3	93	0	0	0	7	E	CERAMICA	INFORME	0	0	0		1991 S
7-3	94	0	0	0	7	W	CERAMICA	INFORME	0	0	0	ARGILA CUITA	1991 S
7-3	95	0	0	0	7	E	CERAMICA	PANXA	0	0	0	2 FRAGS	1991 S
7-3	96	0	0	0	7	W	CERAMICA	PANXA	0	0	0		1991 S
7-3	97	0	0	0	7	W	CERAMICA	INFORME	0	0	0		1991 S
7-3	98	0	0	0	7	W	CERAMICA	VORA	0	0	0		1991 S
7-3	99	0	0	0	7	W	CERAMICA	INFORME	0	0	0		1991 S
7-3	100	0	0	0	7	W	CERAMICA	PANXA	0	0	0		1991 S
7-3	101	0	0	0	7	W	CERAMICA	PANXA	0	0	0		1991 S
7-3	102	0	0	0	7	W	CERAMICA	INFORME	0	0	0		1991 S
7-3	103	0	0	0	7	W	CERAMICA	INFORME	0	0	0		1991 S
7-3	104	0	0	0	7	W	CERAMICA	CARENA	0	0	0		1991 S
7-3	105	0	0	0	7	W	CERAMICA	INFORME	0	0	0		1991 S
7-3	106	0	0	0	7	W	CERAMICA	INFORME	0	0	0		1991 S
7-3	107	0	0	0	7	W	CERAMICA	INFORME	0	0	0		1991 S
7-3	108	0	0	0	7	W	CERAMICA	INFORME	0	0	0		1991 S
7-3	109	0	0	0	7	W	CERAMICA	INFORME	0	0	0		1991 S
7-3	110	0	0	0	7	W	CERAMICA	PANXA	0	0	0		1991 S
7-3	111	0	0	0	7	W	CERAMICA	CARENA	0	0	0		1991 S
7-3	112	0	0	0	7	W	CERAMICA	VORA	0	0	0		1991 S
7-3	113	0	0	0	7	W	CERAMICA	INFORME	0	0	0		1991 S
7-3	114	0	0	0	7	W	CERAMICA	INFORME	0	0	0		1991 S
7-3	115	0	0	0	7	W	CERAMICA	INFORME	0	0	0		1991 S
7-3	116	0	0	0	7	W	CERAMICA	INFORME	0	0	0		1991 S
7-3	117	0	0	0	7	W	CERAMICA	FONS	0	0	0		1991 S
7-3	118	0	0	0	7	W	CERAMICA	INFORME	0	0	0		1991 S
7-3	119	0	0	0	7	W	CERAMICA	INFORME	0	0	0		1991 S
7-3	120	0	0	0	7	W	CERAMICA	INFORME	0	0	0	VARIS FRAGS	1991 S
7-3	121	0	0	0	7	W	CERAMICA	VORA	0	0	0		1991 S
7-3	122	0	0	0	7	W	CERAMICA	INFORME	0	0	0		1991 S
7-3	123	0	0	0	7	W	CERAMICA	INFORME	0	0	0	2 FRAGS	1991 S
7-3	124	0	0	0	7	W	CERAMICA	PANXA	0	0	0		1991 S
7-3	125	0	0	0	7	W	CERAMICA	INFORME	0	0	0		1991 S

BOBILA MADURELL  
MAS DURAN  
campanya 1991

E.E. NUM.	X	Y	Zsup	Zinf/ Talla	ORIENT	PENDENT SECTOR	MATERIA	OBJECTE	LONG	AMPL	ESPE	ALTERACIONS OBSERVACIONS	P D			
													ANY	U	I	B
													T	U		
7-3	126	0	0	0	7	W	CERAMICA	INFORME	0	0	0		1991	S		
7-3	127	0	0	0	7	W	CERAMICA	INFORME	0	0	0		1991	S		
7-3	128	0	0	0	7	W	CERAMICA	INFORME	0	0	0		1991	S		
7-3	129	0	0	0	7	W	CERAMICA	CARENA	0	0	0	3 FRAGS	1991	S		
7-3	130	0	0	0	7	W	CERAMICA	INFORME	0	0	0		1991	S		
7-3	131	0	0	0	8	E	CERAMICA	VORA	0	0	0		1991	S		
7-3	132	0	0	0	8	E	CERAMICA	INFORME	0	0	0		1991	S		
7-3	133	0	0	0	8	E	CERAMICA	INFORME	0	0	0		1991	S		
7-3	134	0	0	0	8	E	CERAMICA	INFORME	0	0	0	4 FRAGS	1991	S		
7-3	135	0	0	0	8	E	CERAMICA	INFORME	0	0	0		1991	S		
7-3	136	0	0	0	8	E	CERAMICA	INFORME	0	0	0	2 FRAGS	1991	S		
7-3	137	0	0	0	8	E	CERAMICA	PANXA	0	0	0		1991	S		
7-3	138	0	0	0	8	E	CERAMICA	PANXA	0	0	0		1991	S		
7-3	139	0	0	0	8	E	CERAMICA	CARENA	0	0	0	VARIS FRAGS	1991	S		
7-3	140	0	0	0	8	E	CERAMICA	INFORME	0	0	0	ARGILA CUITA	1991	S		
7-3	141	0	0	0	8	E	CERAMICA	INFORME	0	0	0	2 FRAGS	1991	S		
7-3	142	0	0	0	8	E	CERAMICA	PANXA	0	0	0		1991	S		
7-3	143	0	0	0	8	E	CERAMICA	INFORME	0	0	0		1991	S		
7-3	144	0	0	0	8	E	CERAMICA	INFORME	0	0	0	ARGILA CUITA	1991	S		
7-3	145	0	0	0	8	E	CERAMICA	INFORME	0	0	0		1991	S		
7-3	146	0	0	0	8	E	CERAMICA	INFORME	0	0	0		1991	S		
7-3	147	0	0	0	8	E	CERAMICA	INFORME	0	0	0		1991	S		
7-3	148	0	0	0	8	E	CERAMICA	PANXA	0	0	0		1991	S		
7-3	149	0	0	0	8	E	CERAMICA	PANXA	0	0	0		1991	S		
7-3	150	0	0	0	8	E	CERAMICA	APLICA	0	0	0	LLENG VORA FRAG	1991	S		
7-3	151	0	0	0	8	E	CERAMICA	PANXA	0	0	0		1991	S		
7-3	152	0	0	0	8	E	CERAMICA	APLICA	0	0	0	MUGRO VAR.FRAGS	1991	S		
7-3	153	0	0	0	8	E	CERAMICA	CARENA	0	0	0		1991	S		
7-3	154	0	0	0	8	E	CERAMICA	INFORME	0	0	0		1991	S		
7-3	155	0	0	0	8	E	CERAMICA	INFORME	0	0	0	2 FRAGS	1991	S		
7-3	156	0	0	0	8	E	CERAMICA	INFORME	0	0	0		1991	S		
7-3	157	0	0	0	8	E	CERAMICA	INFORME	0	0	0	2 FRAGS	1991	S		
7-3	158	0	0	0	8	E	CERAMICA	INFORME	0	0	0		1991	S		
7-3	159	0	0	0	8	E	CERAMICA	INFORME	0	0	0		1991	S		
7-3	160	0	0	0	8	E	CERAMICA	INFORME	0	0	0		1991	S		
7-3	161	0	0	0	8	E	CERAMICA	INFORME	0	0	0		1991	S		
7-3	162	0	0	0	8	E	CERAMICA	INFORME	0	0	0		1991	S		
7-3	163	0	0	0	8	E	CERAMICA	INFORME	0	0	0		1991	S		
7-3	164	0	0	0	8	E	CERAMICA	PANXA	0	0	0		1991	S		
7-3	165	0	0	0	8	E	CERAMICA	PANXA	0	0	0		1991	S		
7-3	166	0	0	0	8	E	CERAMICA	CARENA	0	0	0		1991	S		
7-3	167	0	0	0	8	E	CERAMICA	VORA	0	0	0		1991	S		
7-3	168	0	0	0	8	E	CERAMICA	PANXA	0	0	0		1991	S		
7-3	169	0	0	0	8	E	CERAMICA	INFORME	0	0	0		1991	S		
7-3	170	0	0	0	8	E	CERAMICA	VORA	0	0	0		1991	S		
7-3	171	0	0	0	8	E	CERAMICA	INFORME	0	0	0		1991	S		
7-3	172	0	0	0	8	E	CERAMICA	INFORME	0	0	0		1991	S		
7-3	173	0	0	0	8	E	CERAMICA	INFORME	0	0	0	3 FRAGS	1991	S		
7-3	174	0	0	0	8	E	CERAMICA	INFORME	0	0	0		1991	S		
7-3	175	0	0	0	8	E	CERAMICA	INFORME	0	0	0		1991	S		
7-3	176	0	0	0	8	E	CERAMICA	INFORME	0	0	0	2 FRAGS	1991	S		

BOBILA MADURELL  
MAS DURAN  
campanya 1991

E.E. NUM.	X	Y	Zsup	Zinf/ Talla	ORIENT	PENDENT SECTOR	MATERIA	OBJECTE	LONG	AMPL	ESPE	ALTERACIONS	P D
												OBSERVACIONS	
7-3	177	0	0	0	8	E	CERAMICA PANXA		0	0	0	CREMAT A L'EXT.	1991 S
7-3	178	0	0	0	8	E	CERAMICA INFORME		0	0	0		1991 S
7-3	179	0	0	0	8	E	CERAMICA PANXA		0	0	0		1991 S
7-3	180	0	0	0	8	E	CERAMICA VORA		0	0	0	INCISIO A L'EXT	1991 S
7-3	181	0	0	0	8	E	CERAMICA VORA		0	0	0		1991 S
7-3	182	0	0	0	8	E	CERAMICA PANXA		0	0	0	VARIS FRAGS	1991 S
7-3	183	0	0	0	8	E	CERAMICA INFORME		0	0	0		1991 S
7-3	184	0	0	0	8	E	CERAMICA VORA		0	0	0	VARIS FRAGS	1991 S
7-3	185	0	0	0	8	E	CERAMICA VORA		0	0	0	VARIS FRAGS	1991 S
7-3	186	0	0	0	8	E	CERAMICA APLICA		0	0	0	MAMELO VAR.FRAG	1991 S
7-3	187	0	0	0	8	E	CERAMICA INFORME		0	0	0		1991 S
7-3	188	0	0	0	8	E	CERAMICA NANSA		0	0	0		1991 S
7-3	189	0	0	0	8	E	CERAMICA PANXA		0	0	0		1991 S
7-3	190	0	0	0	8	E	CERAMICA INFORME		0	0	0	2 FRAGS	1991 S
7-3	191	0	0	0	8	E	CERAMICA INFORME		0	0	0	3 FRAGS	1991 S
7-3	192	0	0	0	8	E	CERAMICA INFORME		0	0	0		1991 S
7-3	193	0	0	0	8	W	CERAMICA CARENA		0	0	0		1991 S
7-3	194	0	0	0	8	E	CERAMICA PANXA		0	0	0		1991 S
7-3	195	0	0	0	8	E	CERAMICA INFORME		0	0	0	ARGILA CUITA	1991 S
7-3	196	0	0	0	8	E	CERAMICA INFORME		0	0	0		1991 S
7-3	197	0	0	0	8	E	CERAMICA INFORME		0	0	0	ARGILA CUITA	1991 S
7-3	198	0	0	0	8	E	CERAMICA INFORME		0	0	0		1991 S
7-3	199	0	0	0	8	W	CERAMICA PANXA		0	0	0		1991 S
7-3	200	0	0	0	8	W	CERAMICA INFORME		0	0	0		1991 S
7-3	201	0	0	0	8	W	CERAMICA PANXA		0	0	0		1991 S
7-3	202	0	0	0	8	W	CERAMICA INFORME		0	0	0		1991 S
7-3	203	0	0	0	8	W	CERAMICA PANXA		0	0	0	DECORACIO OVAL	1991 S
7-3	204	0	0	0	8		CERAMICA CARENA		0	0	0	VARIS FRAGS	1991 S
7-3	205	0	0	0	8	W	CERAMICA INFORME		0	0	0		1991 S
7-3	206	0	0	0	8	W	CERAMICA PANXA		0	0	0		1991 S
7-3	207	0	0	0	8	W	CERAMICA PANXA		0	0	0		1991 S
7-3	208	0	0	0	8	W	CERAMICA INFORME		0	0	0		1991 S
7-3	209	0	0	0	8	W	CERAMICA PANXA		0	0	0	VARIS FRAGS	1991 S
7-3	210	0	0	0	8	W	CERAMICA INFORME		0	0	0	DEC.INT.INCISIO	1991 S
7-3	211	0	0	0	8	W	CERAMICA INFORME		0	0	0		1991 S
7-3	212	0	0	0	8	W	CERAMICA INFORME		0	0	0		1991 S
7-3	213	0	0	0	8	W	CERAMICA INFORME		0	0	0		1991 S
7-3	214	0	0	0	8	W	CERAMICA INFORME		0	0	0		1991 S
7-3	215	0	0	0	8	W	CERAMICA INFORME		0	0	0	DOS FRAGS	1991 S
7-3	216	0	0	0	8	W	CERAMICA INFORME		0	0	0	VARIS FRAGS	1991 S
7-3	217	0	0	0	8	W	TOVOT FRAG		0	0	0		1991 S
7-3	218	0	0	0	8	W	CERAMICA INFORME		0	0	0		1991 S
7-3	219	0	0	0	8	W	CERAMICA INFORME		0	0	0		1991 S
7-3	220	0	0	0	8	W	CERAMICA INFORME		0	0	0		1991 S
7-3	221	0	0	0	9	E	CERAMICA INFORME		0	0	0		1991 S
7-3	222	0	0	0	9	E	CERAMICA INFORME		0	0	0		1991 S
7-3	223	0	0	0	9	E	CERAMICA VORA		0	0	0		1991 S
7-3	224	0	0	0	9	E	CERAMICA INFORME		0	0	0		1991 S
7-3	225	0	0	0	9	E	CERAMICA INFORME		0	0	0		1991 S
7-3	226	0	0	0	9	E	CERAMICA INFORME		0	0	0		1991 S
7-3	227	0	0	0	9	E	CERAMICA INFORME		0	0	0		1991 S



BOBILA MADURELL  
MAS DURAN  
campanya 1991

E.E. NUM.	X	Y	Zsup	Zinf/ Talla	ORIENT	PENDENT SECTOR	MATERIA	OBJECTE	LONG	AMPL	ESPE	ALTERACIONS	P D
												OBSERVACIONS	ANY U I N B T U
7-3	228	0	0	0	9	E	CERAMICA	INFORME	0	0	0		1991 S
7-3	229	0	0	0	9	E	CERAMICA	PANXA	0	0	0	VARIS FRAGS	1991 S
7-3	230	0	0	0	9	E	CERAMICA	VORA	0	0	0	EXVASAT INC.INT	1991 S
7-3	231	0	0	0	9	E	CERAMICA	INFORME	0	0	0		1991 S
7-3	232	0	0	0	9	E	CERAMICA	VORA	0	0	0	VARIS FRAGS	1991 S
7-3	233	0	0	0	9	E	CERAMICA	INFORME	0	0	0		1991 S
7-3	234	0	0	0	9	E	CERAMICA	INFORME	0	0	0	VARIS FRAGS	1991 S
7-3	235	0	0	0	9	E	CERAMICA	INFORME	0	0	0	3 FRAGS	1991 S
7-3	236	0	0	0	9	E	CERAMICA	INFORME	0	0	0		1991 S
7-3	237	0	0	0	9	E	CERAMICA	INFORME	0	0	0		1991 S
7-3	238	0	0	0	9	W	CERAMICA	INFORME	0	0	0	VARIS FRAGS	1991 S
7-3	239	0	0	0	10	E	CERAMICA	PANXA	0	0	0		1991 S
7-3	240	0	0	0	10	E	CERAMICA	NANSA	0	0	0	CARENA VORA DEC	1991 S
7-3	241	0	0	0	10	E	CERAMICA	APLICA	0	0	0	MUGRO AMB VORA	1991 S
7-3	242	0	0	0	10	E	CERAMICA	PANXA	0	0	0		1991 S
7-3	243	0	0	0	10	E	CERAMICA	INFORME	0	0	0		1991 S
7-3	244	0	0	0	10	E	CERAMICA	INFORME	0	0	0	VARIS FRAGS	1991 S
7-3	245	0	0	0	10	E	CERAMICA	VORA	0	0	0	4 FRAGS	1991 S
7-3	246	0	0	0	10	E	CERAMICA	VORA	0	0	0	VARIS FRAGS	1991 S
7-3	247	0	0	0	10	E	CERAMICA	INFORME	0	0	0		1991 S
7-3	248	0	0	0	10	E	CERAMICA	VORA	0	0	0	MOLTS FRAGS	1991 S
7-3	249	0	0	0	10	E	CERAMICA	INFORME	0	0	0	VARIS FRAGS	1991 S
7-3	250	0	0	0	10	E	CERAMICA	PANXA	0	0	0		1991 S
7-3	251	0	0	0	10	E	CERAMICA	INFORME	0	0	0	2 FRAGS	1991 S
7-3	252	0	0	0	10	E	CERAMICA	VORA	0	0	0		1991 S
7-3	253	0	0	0	10	E	CERAMICA	INFORME	0	0	0		1991 S
7-3	254	0	0	0	10	E	CERAMICA	PANXA	0	0	0		1991 S
7-3	255	0	0	0	10	E	CERAMICA	INFORME	0	0	0		1991 S
7-3	256	0	0	0	10	E	CERAMICA	VORA	0	0	0		1991 S
7-3	257	0	0	0	10	E	CERAMICA	INFORME	0	0	0		1991 S
7-3	258	0	0	0	10	E	CERAMICA	VORA	0	0	0		1991 S
7-3	259	0	0	0	10	E	CERAMICA	INFORME	0	0	0		1991 S
7-3	260	0	0	0	10	E	CERAMICA	INFORME	0	0	0	2 FRAGS	1991 S
7-3	261	0	0	0	10	E	CERAMICA	INFORME	0	0	0		1991 S
7-3	262	0	0	0	10	E	CERAMICA	VORA	0	0	0		1991 S
7-3	263	0	0	0	10	E	CERAMICA	INFORME	0	0	0		1991 S
7-3	264	0	0	0	10	E	CERAMICA	INFORME	0	0	0		1991 S
7-3	265	0	0	0	10	E	CERAMICA	INFORME	0	0	0		1991 S
7-3	266	0	0	0	10	E	CERAMICA	INFORME	0	0	0		1991 S
7-3	267	0	0	0	10	E	CERAMICA	INFORME	0	0	0		1991 S
7-3	268	0	0	0	10	E	CERAMICA	INFORME	0	0	0		1991 S
7-3	269	0	0	0	10	E	CERAMICA	INFORME	0	0	0		1991 S
7-3	270	0	0	0	10	E	CERAMICA	VORA	0	0	0		1991 S
7-3	271	0	0	0	10	E	CERAMICA	INFORME	0	0	0	MOLTS FRAGS	1991 S
7-3	272	0	0	0	10	E	CERAMICA	INFORME	0	0	0	4 FRAGS	1991 S
7-3	273	0	0	0	10	E	CERAMICA	INFORME	0	0	0		1991 S
7-3	274	0	0	0	10	E	CERAMICA	VORA	0	0	0		1991 S
7-3	275	0	0	0	10	E	CERAMICA	PANXA	0	0	0		1991 S
7-3	276	0	0	0	10	E	CERAMICA	INFORME	0	0	0	VARIS FRAGS	1991 S
7-3	277	0	0	0	10	E	CERAMICA	INFORME	0	0	0		1991 S
7-3	278	0	0	0	10	E	CERAMICA	INFORME	0	0	0		1991 S

BOBILA MADURELL  
MAS DURAN  
campanya 1991

E.E. NUM.	X	Y	Zsup	Zinf/ Talla	ORIENT	PENDENT SECTOR	MATERIA	OBJECTE	LONG	AMPL	ESPE	ALTERACIONS	P D
												OBSERVACIONS	ANY U I N B T U
7-3	279	0	0	0	10	E	CERAMICA	INFORME	0	0	0		1991 S
7-3	280	0	0	0	10	E	CERAMICA	CARENA	0	0	0		1991 S
7-3	281	0	0	0	10	E	CERAMICA	INFORME	0	0	0		1991 S
7-3	282	0	0	0	10	E	CERAMICA	VORA	0	0	0		1991 S
7-3	283	0	0	0	10	E	CERAMICA	INFORME	0	0	0		1991 S
7-3	284	0	0	0	10	E	CERAMICA	INFORME	0	0	0		1991 S
7-3	285	0	0	0	10	E	CERAMICA	INFORME	0	0	0		1991 S
7-3	286	0	0	0	10	E	CERAMICA	INFORME	0	0	0		1991 S
7-3	287	0	0	0	10	E	CERAMICA	INFORME	0	0	0		1991 S
7-3	288	0	0	0	10	E	CERAMICA	INFORME	0	0	0		1991 S
7-3	289	0	0	0	10	E	CERAMICA	INFORME	0	0	0		1991 S
7-3	290	0	0	0	10	E	CERAMICA	INFORME	0	0	0		1991 S
7-3	291	0	0	0	10	E	CERAMICA	INFORME	0	0	0		1991 S
7-3	292	0	0	0	10	E	CERAMICA	INFORME	0	0	0		1991 S
7-3	293	0	0	0	10	E	CERAMICA	INFORME	0	0	0		1991 S
7-3	294	0	0	0	10	E	CERAMICA	VORA	0	0	0		1991 S
7-3	295	0	0	0	10	E	CERAMICA	VORA	0	0	0		1991 S
7-3	296	0	0	0	10	E	CERAMICA	INFORME	0	0	0		1991 S
7-3	297	0	0	0	10	E	CERAMICA	INFORME	0	0	0		1991 S
7-3	298	0	0	0	10	E	CERAMICA	VORA	0	0	0		1991 S
7-3	299	0	0	0	10	E	CERAMICA	NANSA	0	0	0		1991 S
7-3	300	0	0	0	10	E	CERAMICA	VORA	0	0	0		1991 S
7-3	301	0	0	0	10	E	CERAMICA	VORA	0	0	0		1991 S
7-3	302	0	0	0	10	E	CERAMICA	INFORME	0	0	0		1991 S
7-3	303	0	0	0	10	E	CERAMICA	VORA	0	0	0		1991 S
7-3	304	0	0	0	10	E	CERAMICA	INFORME	0	0	0		1991 S
7-3	305	0	0	0	10	E	CERAMICA	INFORME	0	0	0		1991 S
7-3	306	0	0	0	10	E	CERAMICA	INFORME	0	0	0		1991 S
7-3	307	0	0	0	10	E	CERAMICA	VORA	0	0	0		1991 S
7-3	308	0	0	0	10	E	CERAMICA	NANSA	0	0	0	FRAG	1991 S
7-3	309	0	0	0	10	E	CERAMICA	INFORME	0	0	0	VARIS FRAGS	1991 S
7-3	310	0	0	0	10	E	CERAMICA	INFORME	0	0	0		1991 S
7-3	311	0	0	0	10	E	CERAMICA	INFORME	0	0	0		1991 S
7-3	312	0	0	0	10	E	CERAMICA	INFORME	0	0	0		1991 S
7-3	313	0	0	0	10	E	CERAMICA	INFORME	0	0	0		1991 S
7-3	314	0	0	0	10	E	CERAMICA	INFORME	0	0	0		1991 S
7-3	315	0	0	0	10	E	CERAMICA	INFORME	0	0	0		1991 S
7-3	316	0	0	0	10	E	CERAMICA	INFORME	0	0	0		1991 S
7-3	317	0	0	0	10	E	CERAMICA	VORA	0	0	0	VARIS FRAGS	1991 S
7-3	318	0	0	0	10	E	CERAMICA	VORA	0	0	0		1991 S
7-3	319	0	0	0	10	E	CERAMICA	INFORME	0	0	0		1991 S
7-3	320	0	0	0	10	W	CERAMICA	INFORME	0	0	0	2 FRAGS	1991 S
7-3	321	0	0	0	10	W	CERAMICA	INFORME	0	0	0	2 FRAGS	1991 S
7-3	322	0	0	0	10	W	CERAMICA	PANXA	0	0	0	3 FRAGS	1991 S
7-3	323	0	0	0	10	W	CERAMICA	NANSA	0	0	0	AMB VORA FRAG	1991 S
7-3	324	0	0	0	10	W	CERAMICA	INFORME	0	0	0		1991 S
7-3	325	0	0	0	10	W	CERAMICA	INFORME	0	0	0		1991 S
7-3	326	0	0	0	10	W	CERAMICA	INFORME	0	0	0		1991 S
7-3	327	0	0	0	10	W	CERAMICA	VORA	0	0	0	VARIS FRAGS	1991 S
7-3	328	0	0	0	10	W	CERAMICA	VORA	0	0	0		1991 S
7-3	329	0	0	0	10	W	CERAMICA	INFORME	0	0	0		1991 S

BOBILA MADURELL  
MAS DURAN  
campanya 1991

E.E. NUM.	X	Y	Zsup	Zinf/ Talla	ORIENT	PENDENT SECTOR	MATERIA	OBJECTE	LONG	AMPL	ESPE	ALTERACIONS	P D
												OBSERVACIONS	ANY U I N B T U
7-3	330	0	0	0	10	W	CERAMICA	INFORME	0	0	0		1991 S
7-3	331	0	0	0	10	W	CERAMICA	INFORME	0	0	0		1991 S
7-3	332	0	0	0	10	W	CERAMICA	VORA	0	0	0		1991 S
7-3	333	0	0	0	10	W	CERAMICA	VORA	0	0	0	3 FRAGS	1991 S
7-3	334	0	0	0	10	W	CERAMICA	NANSA	0	0	0	VARIS FRAGS	1991 S
7-3	335	0	0	0	10	W	CERAMICA	INFORME	0	0	0		1991 S
7-3	336	0	0	0	10	W	CERAMICA	VORA	0	0	0		1991 S
7-3	337	0	0	0	10	W	CERAMICA	VORA	0	0	0		1991 S
7-3	338	0	0	0	10	W	CERAMICA	INFORME	0	0	0		1991 S
7-3	339	0	0	0	10	W	CERAMICA	INFORME	0	0	0		1991 S
7-3	340	0	0	0	10	W	CERAMICA	INFORME	0	0	0		1991 S
7-3	341	0	0	0	10	W	CERAMICA	VORA	0	0	0		1991 S
7-3	342	0	0	0	10	W	CERAMICA	INFORME	0	0	0	DECORACIO?	1991 S
7-3	343	0	0	0	10	W	CERAMICA	INFORME	0	0	0		1991 S
7-3	344	0	0	0	10	W	CERAMICA	INFORME	0	0	0		1991 S
7-3	345	0	0	0	10	W	CERAMICA	VORA	0	0	0		1991 S
7-3	346	0	0	0	10	W	CERAMICA	INFORME	0	0	0		1991 S
7-3	347	0	0	0	10	W	CERAMICA	VORA	0	0	0		1991 S
7-3	348	0	0	0	10	W	CERAMICA	INFORME	0	0	0	2 FRAGS	1991 S
7-3	349	0	0	0	10	W	CERAMICA	PANXA	0	0	0		1991 S
7-3	350	0	0	0	10	W	CERAMICA	INFORME	0	0	0		1991 S
7-3	351	0	0	0	10	W	CERAMICA	INFORME	0	0	0		1991 S
7-3	352	0	0	0	10	W	CERAMICA	VORA	0	0	0		1991 S
7-3	353	0	0	0	10	W	CERAMICA	INFORME	0	0	0		1991 S
7-3	354	0	0	0	10	W	CERAMICA	INFORME	0	0	0		1991 S
7-3	355	0	0	0	10	W	CERAMICA	INFORME	0	0	0		1991 S
7-3	356	0	0	0	10	W	CERAMICA	INFORME	0	0	0		1991 S
7-3	357	0	0	0	10	W	CERAMICA	INFORME	0	0	0		1991 S
7-3	358	0	0	0	10	W	CERAMICA	INFORME	0	0	0		1991 S
7-3	359	0	0	0	10	W	CERAMICA	INFORME	0	0	0		1991 S
7-3	360	0	0	0	10	W	CERAMICA	INFORME	0	0	0		1991 S
7-3	361	0	0	0	10	W	CERAMICA	INFORME	0	0	0		1991 S
7-3	362	0	0	0	10	W	CERAMICA	INFORME	0	0	0		1991 S
7-3	363	0	0	0	10	W	CERAMICA	INFORME	0	0	0		1991 S
7-3	364	0	0	0	10	W	CERAMICA	INFORME	0	0	0		1991 S
7-3	365	0	0	0	10	W	CERAMICA	INFORME	0	0	0		1991 S
7-3	366	0	0	0	10	W	CERAMICA	INFORME	0	0	0		1991 S
7-3	367	0	0	0	10	W	CERAMICA	INFORME	0	0	0		1991 S
7-3	368	0	0	0	10	W	CERAMICA	VORA	0	0	0		1991 S
7-3	369	0	0	0	10	W	CERAMICA	INFORME	0	0	0		1991 S
7-3	370	0	0	0	10	W	CERAMICA	INFORME	0	0	0		1991 S
7-3	371	0	0	0	10	W	CERAMICA	INFORME	0	0	0		1991 S
7-3	372	0	0	0	10	W	CERAMICA	INFORME	0	0	0		1991 S
7-3	373	0	0	0	10	W	CERAMICA	INFORME	0	0	0		1991 S
7-3	374	0	0	0	10	W	CERAMICA	VORA	0	0	0		1991 S
7-3	375	0	0	0	10	W	CERAMICA	INFORME	0	0	0		1991 S
7-3	376	0	0	0	10	W	CERAMICA	INFORME	0	0	0		1991 S
7-3	377	0	0	0	10	W	CERAMICA	PANXA	0	0	0		1991 S
7-3	378	0	0	0	11	E	CERAMICA	VORA	0	0	0		1991 S
7-3	379	0	0	0	11	E	CERAMICA	PANXA	0	0	0		1991 S
7-3	380	0	0	0	11	E	CERAMICA	NANSA	0	0	0		1991 S

BOBILA MADURELL  
MAS DURAN  
campanya 1991

E.E. NUM.	X	Y	Zsup	Zinf/ Talla	ORIENT	PENDENT SECTOR	MATERIA	OBJECTE	LONG	AMPL	ESPE	ALTERACIONS	P D
												OBSERVACIONS	
7-3	381	0	0	0	11	E	CERAMICA	INFORME	0	0	0		1991 S
7-3	382	0	0	0	11	E	CERAMICA	INFORME	0	0	0	5 FRAGS	1991 S
7-3	383	0	0	0	11	E	CERAMICA	INFORME	0	0	0		1991 S
7-3	384	0	0	0	11	E	CERAMICA	INFORME	0	0	0		1991 S
7-3	385	0	0	0	11	E	CERAMICA	INFORME	0	0	0	2 FRAGS	1991 S
7-3	386	0	0	0	11	E	CERAMICA	INFORME	0	0	0		1991 S
7-3	387	0	0	0	11	E	CERAMICA	INFORME	0	0	0	2 FRAGS	1991 S
7-3	388	0	0	0	11	E	CERAMICA	PANXA	0	0	0		1991 S
7-3	389	0	0	0	11	E	CERAMICA	INFORME	0	0	0		1991 S
7-3	390	0	0	0	11	E	CERAMICA	INFORME	0	0	0		1991 S
7-3	391	0	0	0	11	E	CERAMICA	VORA	0	0	0		1991 S
7-3	392	0	0	0	11	E	CERAMICA	INFORME	0	0	0		1991 S
7-3	393	0	0	0	11	E	CERAMICA	INFORME	0	0	0	2 FRAGS	1991 S
7-3	394	0	0	0	11	E	CERAMICA	VORA	0	0	0		1991 S
7-3	395	0	0	0	11	E	CERAMICA	INFORME	0	0	0		1991 S
7-3	396	0	0	0	11	E	CERAMICA	INFORME	0	0	0	2 FRAGS	1991 S
7-3	397	0	0	0	11	E	CERAMICA	INFORME	0	0	0		1991 S
7-3	398	0	0	0	11	E	CERAMICA	INFORME	0	0	0	VARIS FRAGS	1991 S
7-3	399	0	0	0	11	E	CERAMICA	INFORME	0	0	0		1991 S
7-3	400	0	0	0	11	E	CERAMICA	INFORME	0	0	0		1991 S
7-3	401	0	0	0	11	E	CERAMICA	CARENA	0	0	0		1991 S
7-3	402	0	0	0	11	E	CERAMICA	INFORME	0	0	0		1991 S
7-3	403	0	0	0	11	E	CERAMICA	INFORME	0	0	0	VARIS FRAGS	1991 S
7-3	404	0	0	0	11	E	CERAMICA	INFORME	0	0	0		1991 S
7-3	405	0	0	0	11	E	CERAMICA	INFORME	0	0	0	VARIS FRAGS	1991 S
7-3	406	0	0	0	11	W	CERAMICA	PANXA	0	0	0		1991 S
7-3	407	0	0	0	11	W	CERAMICA	VORA	0	0	0	VARIS FRAGS	1991 S
7-3	408	0	0	0	11	W	CERAMICA	PANXA	0	0	0		1991 S
7-3	409	0	0	0	11	W	CERAMICA	INFORME	0	0	0		1991 S
7-3	410	0	0	0	6	E	SILEX	BPF	0	0	0		1991 S
7-3	411	0	0	0	7	E	SILEX	BN1G	0	0	0		1991 S
7-3	412	0	0	0	7	E	SILEX	BPF	0	0	0	FRAG LAMINA	1991 S
7-3	413	0	0	0	7	E	SILEX	BPF	0	0	0	FRAG LAMINA	1991 S
7-3	414	0	0	0	7	W	SILEX	BPF	0	0	0	FRAG LAMINA	1991 S
7-3	415	0	0	0	8	E	SILEX	BP	0	0	0		1991 S
7-3	416	0	0	0	8	E	SILEX	BP2G	0	0	0		1991 S
7-3	417	0	0	0	8	E	SILEX	BPF	0	0	0	FRAG LAMINA	1991 S
7-3	418	0	0	0	8	E	SILEX	BPF	0	0	0	3 FRAGS	1991 S
7-3	419	0	0	0	8	W	SILEX	BP2G	0	0	0		1991 S
7-3	420	0	0	0	9	E	SILEX	BPF	0	0	0	FRAG LAMINA	1991 S
7-3	421	0	0	0	9	W	SILEX	BPF	0	0	0	FRAG LAMINA	1991 S
7-3	422	0	0	0	9	W	SILEX	BPF	0	0	0	2 FRAG LAMINA	1991 S
7-3	423	0	0	0	9	W	SILEX	BPF	0	0	0	FRAG LAMINA	1991 S
7-3	424	0	0	0	9	W	SILEX	BPF	0	0	0	FRAG LAMINA	1991 S
7-3	425	0	0	0	10	E	SILEX	BPF	0	0	0	FRAG LAMINA	1991 S
7-3	426	0	0	0	10	E	SILEX	BPF	0	0	0	FRAG LAMINA	1991 S
7-3	427	0	0	0	10	E	SILEX	BPF	0	0	0	FRAG LAMINA	1991 S
7-3	428	0	0	0	10	E	SILEX	BP	0	0	0		1991 S
7-3	429	0	0	0	10	E	SILEX	BPF	0	0	0	FRAG LAMINA	1991 S
7-3	430	0	0	0	10	E	CALCARIA	BP	0	0	0		1991 S
7-3	431	0	0	0	10	W	SILEX	BPF	0	0	0	FRAG LAMINA	1991 S

BOBILA MADURELL  
MAS DURAN  
campanya 1991

E.E. NUM.	X	Y	Zsup	Zinf/ Talla	ORIENT	PENDENT SECTOR	MATERIA	OBJECTE	LONG	AMPL	ESPE	ALTERACIONS	P D
												OBSERVACIONS	ANY U I N B T U
7-3	432	0	0	0	10	W	SILEX	BP	0	0	0		1991 S
7-3	433	0	0	0	11	E	SILEX	BN2G	0	0	0		1991 S
7-3	434	0	0	0	11	E	SILEX	BPF	0	0	0	FRAG LAMINA	1991 S
7-3	435	0	0	0	6	E	SORRENCA	BNA	0	0	0	FRAG	1991 S
7-3	436	0	0	0	6	E	SORRENCA	BNA	0	0	0	FRAG	1991 S
7-3	437	0	0	0	6	W	CONGLOME	BNA	0	0	0	MICROCONG FRAG	1991 S
7-3	438	0	0	0	6	W	CERAMICA	INFORME	0	0	0	ARGILA CUITA	1991 S
7-3	439	0	0	0	6	W	CONGLOME	BNA	0	0	0	MICROCON FRAG	1991 S
7-3	440	0	0	0	6	W	RMI	BNA	0	0	0	FRAG	1991 S
7-3	441	0	0	0	6	W	RMI	BNA	0	0	0	FRAG	1991 S
7-3	442	0	0	0	7	E	SORRENCA	BNA	0	0	0	FRAG	1991 S
7-3	443	0	0	0	7	E	SORRENCA	BNA	0	0	0	FRAG	1991 S
7-3	444	0	0	0	7	E	CONGLOME	BNA	0	0	0	FRAG	1991 S
7-3	445	0	0	0	7	E	CONGLOME	BNA	0	0	0	FRAG	1991 S
7-3	446	0	0	0	7	E	SORRENCA	BNA	0	0	0	FRAG	1991 S
7-3	447	0	0	0	7	E	SORRENCA	BNA	0	0	0	FRAG	1991 S
7-3	448	0	0	0	7	E	SORRENCA	BNA	0	0	0	FRAG	1991 S
7-3	449	0	0	0	7	E	INDET	BNA	0	0	0	FRAG	1991 S
7-3	450	0	0	0	7	E	SORRENCA	BNA	0	0	0	FRAG ALTERAT	1991 S
7-3	451	0	0	0	7	W	RMI	BNA	0	0	0	FRAG TERMIC	1991 S
7-3	452	0	0	0	7	W	TOVOT	FRAG	0	0	0		1991 S
7-3	453	0	0	0	7	W	SORRENCA	BNA	0	0	0	FRAG	1991 S
7-3	454	0	0	0	7	W	QUARS	BNA	0	0	0	FRAC	1991 S
7-3	455	0	0	0	7	W	RMI	BNA	0	0	0	FRAG	1991 S
7-3	456	0	0	0	7	W	SORRENCA	BNA	0	0	0	FRAG	1991 S
7-3	457	0	0	0	7	W	SORRENCA	BNA	0	0	0	FRAG TERMIC	1991 S
7-3	458	0	0	0	7	W	RMI	BNA	0	0	0	FRAG TERMIC	1991 S
7-3	459	0	0	0	8	E	SORRENCA	BNA	0	0	0	FRAG ALTERAT	1991 S
7-3	460	0	0	0	8	E	SORRENCA	BNA	0	0	0	FRAG ALTERAT	1991 S
7-3	461	0	0	0	8	E	CALCARIA	BNA	0	0	0	FRAC	1991 S
7-3	462	0	0	0	8	E	RMI	BNA	0	0	0	FRAG	1991 S
7-3	463	0	0	0	8	E	QUARS	BPI	0	0	0		1991 S
7-3	464	0	0	0	8	W	SORRENCA	BNA	0	0	0	FRAG ALTERAT	1991 S
7-3	465	0	0	0	8	W	QUARS	BNA	0	0	0		1991 S
7-3	466	0	0	0	8	W	SORRENCA	BNA	0	0	0	FRAG ALTERAT	1991 S
7-3	467	0	0	0	8	W	SORRENCA	BNA	0	0	0	FRAG ALTERAT	1991 S
7-3	468	0	0	0	9	E	QUARS	BNA	0	0	0	FRAG	1991 S
7-3	469	0	0	0	10	E	RMI	BNA	0	0	0	FRAG TERMIC	1991 S
7-3	470	0	0	0	10	E	QUARS	BPF	0	0	0		1991 S
7-3	471	0	0	0	10	E	RMI	BNA	0	0	0	FRAG TERMIC	1991 S
7-3	472	0	0	0	10	E	RMI	BNA	0	0	0	FRAG	1991 S
7-3	473	0	0	0	10	E	CALCARIA	BNA	0	0	0	FRAG ALTERAT	1991 S
7-3	474	0	0	0	10	E	RMI	BNA	0	0	0	FRAG TERMIC	1991 S
7-3	475	0	0	0	10	E	CONGLOME	BNA	0	0	0	MICROCONGLOME	1991 S
7-3	476	0	0	0	10	E	CONGLOME	BNA	0	0	0	MICROCONGLOME	1991 S
7-3	477	0	0	0	10	E	SORRENCA	BNA	0	0	0	FRAG ALTERAT	1991 S
7-3	478	0	0	0	10	E	SORRENCA	BNA	0	0	0	FRAG TERMIC	1991 S
7-3	479	0	0	0	10	E	QUARS	BNA	0	0	0	FRAC	1991 S
7-3	480	0	0	0	10	E	SORRENCA	BNA	0	0	0	FRAG	1991 S
7-3	481	0	0	0	10	E	INDET	BNA	0	0	0		1991 S
7-3	482	0	0	0	10	E	RMI	BNA	0	0	0	FRAG	1991 S

BOBILA MADURELL  
MAS DURAN  
campanya 1991

E.E. NUM.	X	Y	Zsup	Zinf/ Talla	ORIENT	PENDENT SECTOR	MATERIA	OBJECTE	LONG	AMPL	ESPE	ALTERACIONS	P D
												OBSERVACIONS	ANY U I N B T U
7-3	483	0	0	0	10	E	CONGLOME	BNA	0	0	0	MICROCONG FRAG	1991 S
7-3	484	0	0	0	10	E	RMI	BNA	0	0	0		1991 S
7-3	485	0	0	0	10	E	RMI	BNA	0	0	0	FRAG	1991 S
7-3	486	0	0	0	10	E	RMI	BNA	0	0	0		1991 S
7-3	487	0	0	0	10	E	SORRENCA	BNA	0	0	0	FRAG	1991 S
7-3	488	0	0	0	10	E	ESQUIST	BNA	0	0	0	FRAG	1991 S
7-3	489	0	0	0	10	E	INDET	BNA	0	0	0	FRAG	1991 S
7-3	490	0	0	0	10	W	QUARS	BNA	0	0	0	FRAG	1991 S
7-3	491	0	0	0	10	W	INDET	BNA	0	0	0	FRAG	1991 S
7-3	492	0	0	0	10	W	SORRENCA	BNA	0	0	0	FRAG	1991 S
7-3	493	0	0	0	10	W	RMI	BNA	0	0	0	FRAG	1991 S
7-3	494	0	0	0	10	W	INDET	BNA	0	0	0	FRAG	1991 S
7-3	495	0	0	0	10	W	RMI	BNA	0	0	0	FRAG	1991 S
7-3	496	0	0	0	11	E	SORRENCA	BNA	0	0	0	FRAG	1991 S
7-3	497	0	0	0	11	E	INDET	BNA	0	0	0	FRAG	1991 S
7-3	498	0	0	0	11	E	RMI	BNA	0	0	0	FRAG	1991 S
7-3	499	0	0	0	11	E	SORRENCA	BNA	0	0	0	FRAG TERMIC	1991 S
7-3	500	0	0	0	6	E	OS	BN2G	0	0	0	TREBALLAT FRAG	1991 S
7-3	501	0	0	0	6	E	OS	BN2G	0	0	0	PUNXO 2 FRAG	1991 S
7-3	502	0	0	0	6	E	OS	BN2G	0	0	0	PUNXO	1991 S
7-3	503	0	0	0	7	E	OS	BN2G	0	0	0	TREBALLAT ESPAT	1991 S
7-3	504	0	0	0	8	E	OS	BN2G	0	0	0	PUNXO 2 FRAGS	1991 S
7-3	505	0	0	0	8	E	OS	BN2G	0	0	0	PUNXO	1991 S
7-3	506	0	0	0	9	E	OS	BN2G	0	0	0	PUNXO	1991 S
7-3	507	0	0	0	9	E	OS	BN2G	0	0	0	PUNXO	1991 S
7-3	508	0	0	0	6	E	OS	INDET	0	0	0		1991 S
7-3	509	0	0	0	7	E	OS	INDET	0	0	0		1991 S
7-3	510	0	0	0	7	E	OS	INDET	0	0	0		1991 S
7-3	511	0	0	0	7	E	OS	INDET	0	0	0		1991 S
7-3	512	0	0	0	7	E	OS	INDET	0	0	0		1991 S
7-3	513	0	0	0	7	W	OS	INDET	0	0	0		1991 S
7-3	514	0	0	0	7	W	OS	INDET	0	0	0		1991 S
7-3	515	0	0	0	8	W	OS	INDET	0	0	0		1991 S
7-3	516	0	0	0	7	W	OS	INDET	0	0	0		1991 S
7-3	517	0	0	0	7	W	OS	INDET	0	0	0		1991 S
7-3	518	0	0	0	7	W	OS	INDET	0	0	0		1991 S
7-3	519	0	0	0	7	W	OS	INDET	0	0	0	CREMAT	1991 S
7-3	520	0	0	0	7	W	OS	INDET	0	0	0		1991 S
7-3	521	0	0	0	7	W	OS	INDET	0	0	0		1991 S
7-3	522	0	0	0	7	W	OS	INDET	0	0	0		1991 S
7-3	523	0	0	0	7	W	OS	INDET	0	0	0		1991 S
7-3	524	0	0	0	8	E	OS	INDET	0	0	0		1991 S
7-3	525	0	0	0	8	E	OS	INDET	0	0	0		1991 S
7-3	526	0	0	0	8	E	OS	INDET	0	0	0		1991 S
7-3	527	0	0	0	8	E	OS	INDET	0	0	0		1991 S
7-3	528	0	0	0	8	E	OS	INDET	0	0	0	CREMAT	1991 S
7-3	529	0	0	0	8	W	OS	INDET	0	0	0		1991 S
7-3	530	0	0	0	8	W	OS	INDET	0	0	0		1991 S
7-3	531	0	0	0	9	E	OS	DET	0	0	0	DENT	1991 S
7-3	532	0	0	0	9	E	OS	INDET	0	0	0		1991 S
7-3	533	0	0	0	9	E	OS	INDET	0	0	0		1991 S

BOBILA MADURELL  
MAS DURAN  
campanya 1991

E.E. NUM.	X	Y	Zsup	Zinf/ Talla	ORIENT	PENDENT SECTOR	MATERIA	OBJECTE	LONG	AMPL	ESPE	ALTERACIONS	P D ANY U I N B T U
												OBSERVACIONS	
7-3	534	0	0	0	9	E	OS	DET	0	0	0	DENT	1991 S
7-3	535	0	0	0	9	E	OS	DET	0	0	0	FA	1991 S
7-3	536	0	0	0	9	E	OS	INDET	0	0	0		1991 S
7-3	537	0	0	0	9	E	OS	INDET	0	0	0		1991 S
7-3	538	0	0	0	9	E	OS	DET	0	0	0	DENT	1991 S
7-3	539	0	0	0	9	E	OS	DET	0	0	0	FRAG VT	1991 S
7-3	540	0	0	0	9	E	OS	INDET	0	0	0		1991 S
7-3	541	0	0	0	9	E	OS	INDET	0	0	0	CREMAT	1991 S
7-3	542	0	0	0	9	E	OS	INDET	0	0	0	CREMAT	1991 S
7-3	543	0	0	0	9	W	OS	INDET	0	0	0		1991 S
7-3	544	0	0	0	9	W	OS	INDET	0	0	0		1991 S
7-3	545	0	0	0	10	E	OS	INDET	0	0	0		1991 S
7-3	546	0	0	0	10	E	OS	INDET	0	0	0		1991 S
7-3	547	0	0	0	10	E	OS	DET	0	0	0	DENT	1991 S
7-3	548	0	0	0	10	E	OS	DET	0	0	0	DENT	1991 S
7-3	549	0	0	0	10	E	OS	DET	0	0	0	DENT	1991 S
7-3	550	0	0	0	10	E	OS	DET	0	0	0	DENT	1991 S
7-3	551	0	0	0	10	E	OS	INDET	0	0	0		1991 S
7-3	552	0	0	0	10	E	OS	INDET	0	0	0		1991 S
7-3	553	0	0	0	10	E	OS	INDET	0	0	0		1991 S
7-3	554	0	0	0	10	E	OS	INDET	0	0	0	CREMAT	1991 S
7-3	555	0	0	0	10	E	OS	DET	0	0	0	DENT FRAG	1991 S
7-3	556	0	0	0	10	E	OS	DET	0	0	0	CST FRAG	1991 S
7-3	557	0	0	0	10	E	OS	DET	0	0	0	CST FRAG	1991 S
7-3	558	0	0	0	10	E	OS	DET	0	0	0	CST FRAG	1991 S
7-3	559	0	0	0	10	E	OS	INDET	0	0	0		1991 S
7-3	560	0	0	0	10	E	OS	INDET	0	0	0		1991 S
7-3	561	0	0	0	10	E	OS	DET	0	0	0	EI	1991 S
7-3	562	0	0	0	10	E	OS	INDET	0	0	0	CREMAT	1991 S
7-3	563	0	0	0	10	E	OS	INDET	0	0	0	CREMAT	1991 S
7-3	564	0	0	0	10	E	OS	DET	0	0	0		1991 S
7-3	565	0	0	0	10	E	OS	INDET	0	0	0		1991 S
7-3	566	0	0	0	10	E	OS	INDET	0	0	0	POLIT?	1991 S
7-3	567	0	0	0	10	E	OS	INDET	0	0	0	POLIT?	1991 S
7-3	568	0	0	0	10	E	OS	DET	0	0	0	CST	1991 S
7-3	569	0	0	0	10	E	OS	DET	0	0	0	EI	1991 S
7-3	570	0	0	0	10	E	OS	INDET	0	0	0		1991 S
7-3	571	0	0	0	10	E	OS	INDET	0	0	0		1991 S
7-3	572	0	0	0	10	E	OS	INDET	0	0	0		1991 S
7-3	573	0	0	0	10	E	OS	INDET	0	0	0	CREMAT	1991 S
7-3	574	0	0	0	10	E	OS	INDET	0	0	0	CRAMAT	1991 S
7-3	575	0	0	0	10	E	OS	INDET	0	0	0	CREMAT	1991 S
7-3	576	0	0	0	10	E	OS	INDET	0	0	0	CREMAT	1991 S
7-3	577	0	0	0	10	W	OS	DET	0	0	0	EI	1991 S
7-3	578	0	0	0	10	W	OS	DET	0	0	0	DENT	1991 S
7-3	579	0	0	0	10	W	OS	DET	0	0	0	FRAG MD	1991 S
7-3	580	0	0	0	10	W	OS	DET	0	0	0	DENT	1991 S
7-3	581	0	0	0	10	W	OS	DET	0	0	0	DENT	1991 S
7-3	582	0	0	0	10	W	OS	INDET	0	0	0	CREMAT	1991 S
7-3	583	0	0	0	10	W	OS	INDET	0	0	0	CREMAT	1991 S
7-3	584	0	0	0	11	W	OS	DET	0	0	0	CREMAT	1991 S

BOBILA MADURELL  
MAS DURAN  
campanya 1991

E.E. NUM.	X	Y	Zsup	Zinf/ Talla	ORIENT	PENDENT SECTOR	MATERIA	OBJECTE	LONG	AMPL	ESPE	ALTERACIONS	P D
												OBSERVACIONS	
7-3	585	0	0	0	11	W	OS	INDET	0	0	0	CREMAT	1991 S
7-3	586	0	0	0	11	W	OS	DET	0	0	0		1991 S
7-3	587	0	0	0	11	W	OS	INDET	0	0	0		1991 S
7-3	588	0	0	0	11	W	OS	INDET	0	0	0		1991 S
7-3	589	0	0	0	7	W	OS	INDET	0	0	0	DOS FRAGS	1991 S
7-3	590	0	0	0	7	W	OS	DET	0	0	0		1991 S
7-3	591	0	0	0	7	W	OS	DET	0	0	0		1991 S
7-3	592	0	0	0	7	W	OS	DET	0	0	0		1991 S
7-3	593	0	0	0	7	W	OS	DET	0	0	0		1991 S
7-3	594	0	0	0	7	W	OS	DET	0	0	0		1991 S
7-3	595	0	0	0	7	W	OS	DET	0	0	0		1991 S
7-3	596	0	0	0	7	W	OS	DET	0	0	0		1991 S
7-3	597	0	0	0	7	W	OS	DET	0	0	0		1991 S
7-3	598	0	0	0	7	W	OS	DET	0	0	0		1991 S
7-3	599	0	0	0	7	W	OS	INDET	0	0	0		1991 S
7-3	600	0	0	0	7	W	OS	INDET	0	0	0		1991 S
7-3	601	0	0	0	7	W	OS	INDET	0	0	0		1991 S
7-3	602	0	0	0	7	W	OS	DET	0	0	0	DENT	1991 S
7-3	603	0	0	0	10	W	RMI	BNA	0	0	0	FRAG	1991 S
7-3	604	0	0	0	10	W	CONGLOME	BNA	0	0	0		1991 S
7-3	605	0	0	0	8	E	CONGLOME	BNA	0	0	0	FRAG	1991 S
7-3	606	0	0	0	10	E	SORRENCA	BNA	0	0	0	FRAG TERMIC	1991 S
7-3	607	0	0	0	8	E	TOVOT	FRAG	0	0	0		1991 S
7-3	608	0	0	0	8	E	SORRENCA	BNA	0	0	0	FRAG	1991 S
7-3	609	0	0	0	8	E	SORRENCA	BNA	0	0	0	ALTERAT	1991 S
7-3	610	0	0	0	10	W	SORRENCA	BNA	0	0	0		1991 S
7-3	611	0	0	0	10	W	RMI	BNA	0	0	0	FRAC	1991 S
7-3	612	0	0	0	10	W	ESQUIST	BNA	0	0	0	FRAG	1991 S
7-3	613	0	0	0	10	W	SORRENCA	BNA	0	0	0	FRAG TERMIC	1991 S
7-3	614	0	0	0	10	W	RMI	BNA	0	0	0	FRAG	1991 S
7-3	615	0	0	0	8	E	SORRENCA	BNA	0	0	0	FRAG TERMIC	1991 S
7-3	616	0	0	0	10	W	SORRENCA	BNA	0	0	0	FRAG	1991 S
7-3	617	0	0	0	10	E	ORGANIC	MOLUSC	0	0	0	TREBALLAT	1991 S
7-3	618	0	0	0	9	W	ORGANIC	MOLUSC	0	0	0	PERFORAT	1991 S
7-3	619	0	0	0	10	E	ORGANIC	MOLUSC	0	0	0	PERFORAT	1991 S
7-3	620	0	0	0	10	E	CALAITA	DENA	0	0	0		1991 S
7-3	621	0	0	0	10	E	ESQUIST	BNA	0	0	0	FRAG	1991 S
7-3	622	0	0	0	10	W	OS	DET	0	0	0	CALCINAT	1991 S
7-3	623	0	0	0	11	E	OS	DET	0	0	0		1991 S
7-3	624	0	0	0	11	E	OS	DET	0	0	0	FRAG DENT	1991 S
7-3	625	0	0	0	11	E	OS	INDET	0	0	0	VARIS FRAGS	1991 S
7-3	626	0	0	0	11	E	OS	DET	0	0	0	VARIS FRAGS	1991 S
7-4	1	0	0	0	8	E	CERAMICA	INFORME	0	0	0	VARIS FRAGS	1991 S
7-4	2	0	0	0	8	E	CERAMICA	INFORME	0	0	0		1991 S
7-4	3	0	0	0	8	W	CERAMICA	INFORME	0	0	0		1991 S
7-4	4	0	0	0	9	E	CERAMICA	INFORME	0	0	0	VARIS FRAGS	1991 S
7-4	5	0	0	0	9	E	CERAMICA	INFORME	0	0	0	2 FRAGS	1991 S
7-4	6	0	0	0	9	E	CERAMICA	INFORME	0	0	0		1991 S
7-4	7	0	0	0	9	E	CERAMICA	INFORME	0	0	0		1991 S
7-4	8	0	0	0	9	W	CERAMICA	INFORME	0	0	0	VARIS FRAGS	1991 S
7-4	9	0	0	0	10	E	CERAMICA	INFORME	0	0	0		1991 S



BOBILA MADURELL  
MAS DURAN  
campanya 1991

E.E. NUM.	X	Y	Zsup	Zinf/ Talla	ORIENT	PENDENT SECTOR	MATERIA	OBJECTE	LONG	AMPL	ESPE	ALTERACIONS	P D
												OBSERVACIONS	ANY U I N B T U
7-4	10	0	0	0	10	E	CERAMICA	INFORME	0	0	0		1991 S
7-4	11	0	0	0	10	E	CERAMICA	INFORME	0	0	0		1991 S
7-4	12	0	0	0	10	W	CERAMICA	INFORME	0	0	0		1991 S
7-4	13	0	0	0	10	W	CERAMICA	INFORME	0	0	0	VARIS FRAGS	1991 S
7-4	14	0	0	0	11	E	CERAMICA	INFORME	0	0	0		1991 S
7-4	15	0	0	0	11	E	CERAMICA	INFORME	0	0	0		1991 S
7-4	16	0	0	0	11	E	CERAMICA	INFORME	0	0	0		1991 S
7-4	17	0	0	0	11	E	CERAMICA	INFORME	0	0	0		1991 S
7-4	18	0	0	0	11	E	CERAMICA	INFORME	0	0	0		1991 S
7-4	19	0	0	0	11	E	CERAMICA	INFORME	0	0	0		1991 S
7-4	20	0	0	0	11	E	CERAMICA	INFORME	0	0	0		1991 S
7-4	21	0	0	0	11	E	CERAMICA	INFORME	0	0	0		1991 S
7-4	22	0	0	0	11	E	CERAMICA	INFORME	0	0	0		1991 S
7-4	23	0	0	0	11	E	CERAMICA	INFORME	0	0	0		1991 S
7-4	24	0	0	0	11	E	CERAMICA	INFORME	0	0	0		1991 S
7-4	25	0	0	0	11	E	CERAMICA	NANSA	0	0	0		1991 S
7-4	26	0	0	0	11	E	CERAMICA	INFORME	0	0	0	VARIS FRAGS	1991 S
7-4	27	0	0	0	11	W	CERAMICA	PANXA	0	0	0		1991 S
7-4	28	0	0	0	11	W	CERAMICA	INFORME	0	0	0		1991 S
7-4	29	0	0	0	11	W	CERAMICA	INFORME	0	0	0		1991 S
7-4	30	0	0	0	12	E	CERAMICA	INFORME	0	0	0		1991 S
7-4	31	0	0	0	12	E	CERAMICA	INFORME	0	0	0		1991 S
7-4	32	0	0	0	12	E	CERAMICA	INFORME	0	0	0		1991 S
7-4	33	0	0	0	12	E	CERAMICA	VORA	0	0	0	DEC INTERNA	1991 S
7-4	34	0	0	0	12	E	CERAMICA	INFORME	0	0	0	DEC.INCISA FRAG	1991 S
7-4	35	0	0	0	12	E	CERAMICA	INFORME	0	0	0	VARIS FRAGS	1991 S
7-4	36	0	0	0	12	E	CERAMICA	INFORME	0	0	0		1991 S
7-4	37	0	0	0	12	E	CERAMICA	INFORME	0	0	0		1991 S
7-4	38	0	0	0	12	E	CERAMICA	INFORME	0	0	0		1991 S
7-4	39	0	0	0	12	E	CERAMICA	INFORME	0	0	0		1991 S
7-4	40	0	0	0	12	W	CERAMICA	INFORME	0	0	0	VARIS FRAGS	1991 S
7-4	41	0	0	0	12	W	CERAMICA	VORA	0	0	0		1991 S
7-4	42	0	0	0	12	W	CERAMICA	INFORME	0	0	0		1991 S
7-4	43	0	0	0	12	W	CERAMICA	VORA	0	0	0	VARIS FRAGS	1991 S
7-4	44	0	0	0	12	W	CERAMICA	CARENA	0	0	0		1991 S
7-4	45	0	0	0	12	W	CERAMICA	VORA	0	0	0	VARIS FRAGS	1991 S
7-4	46	0	0	0	12	W	CERAMICA	NANSA	0	0	0		1991 S
7-4	47	0	0	0	13	E	CERAMICA	INFORME	0	0	0		1991 S
7-4	48	0	0	0	13	E	CERAMICA	INFORME	0	0	0		1991 S
7-4	49	0	0	0	13	E	CERAMICA	INFORME	0	0	0		1991 S
7-4	50	0	0	0	13	E	CERAMICA	INFORME	0	0	0		1991 S
7-4	51	0	0	0	13	E	CERAMICA	INFORME	0	0	0		1991 S
7-4	52	0	0	0	13	E	CERAMICA	INFORME	0	0	0		1991 S
7-4	53	0	0	0	13	E	CERAMICA	INFORME	0	0	0		1991 S
7-4	54	0	0	0	13	E	TOVOT	FRAG	0	0	0		1991 S
7-4	55	0	0	0	13	W	CERAMICA	INFORME	0	0	0	VARIS FRAGS	1991 S
7-4	56	0	0	0	13	W	CERAMICA	VORA	0	0	0	2 FRAGS	1991 S
7-4	57	0	0	0	13	W	CERAMICA	INFORME	0	0	0	AMB DECORACIO	1991 S
7-4	58	0	0	0	13	W	CERAMICA	INFORME	0	0	0	3 FRAGS	1991 S
7-4	59	0	0	0	13	W	CERAMICA	INFORME	0	0	0	2 FRAGS	1991 S
7-4	60	0	0	0	8		SILEX	BN2G	0	0	0	DIB.PLANTA:n112	1991 S

BOBILA MADURELL  
MAS DURAN  
campanya 1991

E.E. NUM.	X	Y	Zsup	Zinf/	ORIENT	PENDENT	MATERIA	OBJECTE	LONG	AMPL	ESPE	ALTERACIONS	P D
												OBSERVACIONS	
				Talla	SECTOR							N B	T U
7-4	61	0	0	0	8		SILEX	BN2G	0	0	0	DIB.PLANTA:nI11	1991 S
7-4	62	0	0	0	9	W	CALCARIA	BPF	0	0	0	CREMAT	1991 S
7-4	63	0	0	0	10	W	SILEX	BN2G	0	0	0	GRATADOR	1991 S
7-4	64	0	0	0	10	W	SILEX	BN2G	0	0	0	PUNTA DE SAGETA	1991 S
7-4	65	0	0	0	11	E	SILEX	BN2G	0	0	0	DENTICULAT	1991 S
7-4	66	0	0	0	11	E	SILEX	BN2G	0	0	0	LAMINA	1991 S
7-4	67	0	0	0	11	W	SILEX	BN2G	0	0	0	LAMINA	1991 S
7-4	68	0	0	0	12	E	CRISTALR	BP2G	0	0	0		1991 S
7-4	69	0	0	0	8		RMI	BNA	0	0	0	FRAG/DB.PLANnI3	1991 S
7-4	70	0	0	0	8		SORRENCA	BNA	0	0	0	DIB.PLANTA nI10	1991 S
7-4	71	0	0	0	8		QUARS	BNA	0	0	0	DIB.PLANTA nI13	1991 S
7-4	72	0	0	0	8		SORRENCA	BNA	0	0	0	DIB.PLANTA nI9	1991 S
7-4	73	0	0	0	8		CONGLOME	BNA	0	0	0	FRAG/DB.PLANnI1	1991 S
7-4	74	0	0	0	8	W	SORRENCA	BNA	0	0	0		1991 S
7-4	75	0	0	0	9	W	RMI	BNA	0	0	0	FRAG	1991 S
7-4	76	0	0	0	9	W	SORRENCA	BNA	0	0	0		1991 S
7-4	77	0	0	0	9	W	SORRENCA	BNA	0	0	0	FRAG	1991 S
7-4	78	0	0	0	9	W	QUARS	BNA	0	0	0	FRAG	1991 S
7-4	79	0	0	0	9	W	SORRENCA	BNA	0	0	0		1991 S
7-4	80	0	0	0	9	W	RMI	BNE	0	0	0		1991 S
7-4	81	0	0	0	9	W	RMI	BNA	0	0	0	FRAG	1991 S
7-4	82	0	0	0	10	E	SORRENCA	BNA	0	0	0	FRAG	1991 S
7-4	83	0	0	0	10	E	ESQUIST	BNA	0	0	0	FRAG	1991 S
7-4	84	0	0	0	10	W	CALCARIA	BNA	0	0	0		1991 S
7-4	85	0	0	0	10	W	SORRENCA	BNA	0	0	0		1991 S
7-4	86	0	0	0	10	W	ESQUIST	BNA	0	0	0	FRAG	1991 S
7-4	87	0	0	0	10	W	QUARSITA	BNE	0	0	0		1991 S
7-4	88	0	0	0	12	E	RMI	BNA	0	0	0		1991 S
7-4	89	0	0	0	12	E	QUARSITA	BNA	0	0	0		1991 S
7-4	90	0	0	0	12	E	SORRENCA	BNA	0	0	0	FRAG	1991 S
7-4	91	0	0	0	12	E	RMI	BNA	0	0	0		1991 S
7-4	92	0	0	0	12	E	ESQUIST	BNA	0	0	0	FRAG	1991 S
7-4	93	0	0	0	12	E	SORRENCA	BNA	0	0	0	FRAG	1991 S
7-4	94	0	0	0	12	E	SILEX	BN2G	0	0	0		1991 S
7-4	95	0	0	0	12	W	SORRENCA	BNA	0	0	0	CREMAT	1991 S
7-4	96	0	0	0	12	W	RMI	BNA	0	0	0	FRAG	1991 S
7-4	97	0	0	0	13	E	RMI	BNA	0	0	0	FRAG	1991 S
7-4	98	0	0	0	13	E	SORRENCA	BNA	0	0	0	FRAG	1991 S
7-4	99	0	0	0	13	W	RMI	BNE	0	0	0		1991 S
7-4	100	0	0	0	0	W	OS	BN2G	0	0	0	PUNXO	1991 S
7-4	101	0	0	0	8	E	OS	INDET	0	0	0		1991 S
7-4	102	0	0	0	8	E	OS	INDET	0	0	0		1991 S
7-4	103	0	0	0	8	E	OS	INDET	0	0	0		1991 S
7-4	104	0	0	0	0		OS	INDET	0	0	0	CREMAT	1991 S
7-4	105	0	0	0	0		OS	INDET	0	0	0	CREMAT	1991 S
7-4	106	0	0	0	0		OS	DET	0	0	0	CRA	1991 S
7-4	107	0	0	0	0		OS	DET	0	0	0		1991 S
7-4	108	0	0	0	0		OS	DET	0	0	0	AST	1991 S
7-4	109	0	0	0	0		OS	DET	0	0	0		1991 S
7-4	110	0	0	0	0	W	OS	INDET	0	0	0	CREMAT 2 FRAGS	1991 S
7-4	111	0	0	0	10	E	OS	DET	0	0	0		1991 S

BOBILA MADURELL  
MAS DURAN  
campanya 1991

E.E. NUM.	X	Y	Zsup	Zinf/ Talla	ORIENT	PENDENT SECTOR	MATERIA	OBJECTE	LONG	AMPL	ALTERACIONS		P D
											ESPE	OBSERVACIONS	
7-4	112	0	0	0	10	E	OS	DET	0	0	0		1991 S
7-4	113	0	0	0	10	E	OS	INDET	0	0	0 CREMAT		1991 S
7-4	114	0	0	0	10	E	OS	INDET	0	0	0 CREMAT		1991 S
7-4	115	0	0	0	10	E	OS	DET	0	0	0		1991 S
7-4	116	0	0	0	10	W	OS	DET	0	0	0 CREMAT		1991 S
7-4	117	0	0	0	10	W	OS	DET	0	0	0 CREMAT 3 FRAGS		1991 S
7-4	118	0	0	0	10	W	OS	INDET	0	0	0 CREMAT		1991 S
7-4	119	0	0	0	11	E	OS	DET	0	0	0 2 FRAGS		1991 S
7-4	120	0	0	0	11	E	OS	DET	0	0	0		1991 S
7-4	121	0	0	0	11	E	OS	DET	0	0	0		1991 S
7-4	122	0	0	0	11	E	OS	INDET	0	0	0 CREMAT		1991 S
7-4	123	0	0	0	11	E	OS	INDET	0	0	0 CREMAT		1991 S
7-4	124	0	0	0	11	E	OS	DET	0	0	0 CREMAT		1991 S
7-4	125	0	0	0	11	E	OS	INDET	0	0	0 CREMAT 3 FRAGS		1991 S
7-4	126	0	0	0	11	E	OS	INDET	0	0	0 CREMAT POLIT		1991 S
7-4	127	0	0	0	11	E	OS	DET	0	0	0		1991 S
7-4	128	0	0	0	11	E	OS	DET	0	0	0		1991 S
7-4	129	0	0	0	11	E	OS	DET	0	0	0		1991 S
7-4	130	0	0	0	11	E	OS	DET	0	0	0		1991 S
7-4	131	0	0	0	11	E	OS	DET	0	0	0 VAR.FRAG CREMAT		1991 S
7-4	132	0	0	0	11	E	OS	DET	0	0	0 2 FRAGS		1991 S
7-4	133	0	0	0	11	E	OS	DET	0	0	0		1991 S
7-4	134	0	0	0	11	E	OS	INDET	0	0	0 CREMAT		1991 S
7-4	135	0	0	0	11	E	OS	INDET	0	0	0		1991 S
7-4	136	0	0	0	11	E	OS	INDET	0	0	0		1991 S
7-4	137	0	0	0	11	E	OS	INDET	0	0	0		1991 S
7-4	138	0	0	0	11	E	OS	DET	0	0	0		1991 S
7-4	139	0	0	0	11	E	OS	DET	0	0	0		1991 S
7-4	140	0	0	0	11	E	OS	INDET	0	0	0		1991 S
7-4	141	0	0	0	11	E	OS	INDET	0	0	0 CREMAT		1991 S
7-4	142	0	0	0	11	E	OS	INDET	0	0	0 CREMAT 2 FRAGS		1991 S
7-4	143	0	0	0	11	W	OS	DET	0	0	0		1991 S
7-4	144	0	0	0	11	W	OS	INDET	0	0	0 CREMAT		1991 S
7-4	145	0	0	0	11	W	OS	DET	0	0	0 CREMAT 2 FRAGS		1991 S
7-4	146	0	0	0	11	W	OS	DET	0	0	0 CREMAT		1991 S
7-4	147	0	0	0	11	W	OS	INDET	0	0	0 CREMAT		1991 S
7-4	148	0	0	0	11	W	OS	INDET	0	0	0		1991 S
7-4	149	0	0	0	12	E	OS	DET	0	0	0		1991 S
7-4	150	0	0	0	12	E	OS	INDET	0	0	0		1991 S
7-4	151	0	0	0	12	E	OS	DET	0	0	0		1991 S
7-4	152	0	0	0	12	E	OS	DET	0	0	0		1991 S
7-4	153	0	0	0	12	E	OS	DET	0	0	0		1991 S
7-4	154	0	0	0	12	E	OS	DET	0	0	0		1991 S
7-4	155	0	0	0	12	E	OS	DET	0	0	0 POLIT		1991 S
7-4	156	0	0	0	12	E	OS	DET	0	0	0 CREMAT		1991 S
7-4	157	0	0	0	12	E	OS	DET	0	0	0		1991 S
7-4	158	0	0	0	12	E	OS	DET	0	0	0		1991 S
7-4	159	0	0	0	12	E	OS	INDET	0	0	0		1991 S
7-4	160	0	0	0	12	E	OS	INDET	0	0	0		1991 S
7-4	161	0	0	0	12	E	OS	DET	0	0	0 DENT FRAC		1991 S
7-4	162	0	0	0	12	E	OS	DET	0	0	0 DENT FRAC		1991 S

BOBILA MADURELL  
MAS DURAN  
campanya 1991

E.E. NUM.	X	Y	Zsup	Zinf/ Talla	ORIENT	PENDENT SECTOR	MATERIA	OBJECTE	LONG	AMPL	ESPE	ALTERACIONS	P D
												OBSERVACIONS	ANY U I N B T U
7-4	163	0	0	0	12	E	OS	DET	0	0	0		1991 S
7-4	164	0	0	0	12	E	OS	DET	0	0	0		1991 S
7-4	165	0	0	0	12	E	OS	INDET	0	0	0	CREMAT	1991 S
7-4	166	0	0	0	12	E	OS	INDET	0	0	0		1991 S
7-4	167	0	0	0	12	E	OS	DET	0	0	0		1991 S
7-4	168	0	0	0	12	E	OS	INDET	0	0	0		1991 S
7-4	169	0	0	0	12	E	OS	DET	0	0	0		1991 S
7-4	170	0	0	0	12	E	OS	INDET	0	0	0		1991 S
7-4	171	0	0	0	12	E	OS	DET	0	0	0		1991 S
7-4	172	0	0	0	12	E	OS	INDET	0	0	0	CREMAT	1991 S
7-4	173	0	0	0	12	E	OS	DET	0	0	0		1991 S
7-4	174	0	0	0	12	E	OS	DET	0	0	0		1991 S
7-4	175	0	0	0	12	E	OS	DET	0	0	0		1991 S
7-4	176	0	0	0	12	E	OS	DET	0	0	0		1991 S
7-4	177	0	0	0	12	E	OS	INDET	0	0	0		1991 S
7-4	178	0	0	0	12	E	OS	INDET	0	0	0		1991 S
7-4	179	0	0	0	12	E	OS	DET	0	0	0		1991 S
7-4	180	0	0	0	12	E	OS	DET	0	0	0	2 FRAGS	1991 S
7-4	181	0	0	0	12	W	OS	BN2G	0	0	0		1991 S
7-4	182	0	0	0	12	W	OS	DET	0	0	0	CRA	1991 S
7-4	183	0	0	0	13	E	OS	DET	0	0	0		1991 S
7-4	184	0	0	0	13	E	OS	DET	0	0	0		1991 S
7-4	185	0	0	0	13	E	OS	INDET	0	0	0	CREMAT VAR.FRAG	1991 S
7-4	186	0	0	0	13	E	OS	INDET	0	0	0	CREMAT	1991 S
7-4	187	0	0	0	13	E	OS	DET	0	0	0		1991 S
7-4	188	0	0	0	13	E	OS	DET	0	0	0		1991 S
7-4	189	0	0	0	13	E	OS	INDET	0	0	0	CREMAT	1991 S
7-4	190	0	0	0	13	E	OS	INDET	0	0	0		1991 S
7-4	191	0	0	0	13	E	OS	INDET	0	0	0		1991 S
7-4	192	0	0	0	13	E	OS	INDET	0	0	0		1991 S
7-4	193	0	0	0	13	E	OS	DET	0	0	0		1991 S
7-4	194	0	0	0	13	E	OS	INDET	0	0	0	CREMAT	1991 S
7-4	195	0	0	0	11	W	ORGANIC	MOLUSC	0	0	0	2 FRAGS	1991 S
7-4	196	0	0	0	12	W	ORGANIC	MOLUSC	0	0	0		1991 S
7-4	197	0	0	0	9	W	RMI	BNA	0	0	0		1991 S
7-4	198	0	0	0	12	W	ESQUIST	BNA	0	0	0	FRAG	1991 S
7-4	199	0	0	0	12	W	RMI	BNE	0	0	0	MOLI DE MA	1991 S
7-4	200	0	0	0	8		OS	INDET	0	0	0	NI4,VARIS FRAGS	1991 S
7-4	201	0	0	0	8		OS	INDET	0	0	0	NI5,2 FRAGS	1991 S
7-4	202	0	0	0	8		OS	INDET	0	0	0	NI13	1991 S
7-4	203	0	0	0	8		OS	INDET	0	0	0	NI6,2 FRAGS	1991 S
7-4	204	0	0	0	8		OS	INDET	0	0	0	NI7,3 FRAGS	1991 S
7-4	205	0	0	0	9	W	OS	DET	0	0	0	VARIS FRAGS	1991 S
7-4	206	0	0	0	9	W	OS	INDET	0	0	0	CREMAT/VAR FRAG	1991 S
7-4	207	0	0	0	9	W	OS	DET	0	0	0	DENT 2 FRAGS	1991 S
7-4	208	0	0	0	11		OS	DET	0	0	0		1991 S
7-4	209	0	0	0	11	E	OS	DET	0	0	0	VARIS FRAGS	1991 S
7-4	210	0	0	0	11	E	OS	DET	0	0	0	DENT	1991 S
7-4	211	0	0	0	11	E	OS	INDET	0	0	0	CREMAT	1991 S
7-4	212	0	0	0	11	E	OS	INDET	0	0	0	CREMAT	1991 S
217	213	0	0	0	11	E	OS	INDET	0	0	0	CREMAT	1991 S

BOBILA MADURELL  
MAS DURAN  
campanya 1991

E.E. NUM.	X	Y	Zsup	Zinf/ Talla	ORIENT	PENDENT SECTOR	MATERIA	OBJECTE	LONG	AMPL	ALTERACIONS		P D	
											ESPE	OBSERVACIONS		ANY
													N B	
													T U	
7-4	214	0	0	0	11	E	OS	DET	0	0	0	VARIS FRAGS	1991	S
7-4	215	0	0	0	11		OS	INDET	0	0	0	3 FRAGS	1991	S
7-4	216	0	0	0	11		OS	INDET	0	0	0	2 FRAGS CREMAT	1991	S
7-4	217	0	0	0	11	E	OS	DET	0	0	0	VARIS FRAGS	1991	S
7-4	218	0	0	0	11	E	OS	INDET	0	0	0	CREMAT	1991	S
7-4	219	0	0	0	11	E	OS	INDET	0	0	0	2 FRAGS	1991	S
7-4	220	0	0	0	11	E	OS	DET	0	0	0	DENT 3 FRAGS	1991	S
7-4	221	0	0	0	13	E	OS	DET	0	0	0	VARIS FRAGS	1991	S
7-4	222	0	0	0	13	E	OS	DET	0	0	0	DENT	1991	S
7-4	223	0	0	0	14	E	OS	INDET	0	0	0	FRAG	1991	S
7-4	224	0	0	0	13	W	OS	INDET	0	0	0		1991	S
7-4	225	0	0	0	13	W	OS	INDET	0	0	0		1991	S
7-4	226	0	0	0	13	W	OS	DET	0	0	0		1991	S
7-4	227	0	0	0	13	W	OS	DET	0	0	0		1991	S
7-4	228	0	0	0	13	W	OS	DET	0	0	0		1991	S
7-4	229	0	0	0	13	W	OS	DET	0	0	0		1991	S
7-4	230	0	0	0	13	W	OS	DET	0	0	0	CREMAT	1991	S
7-4	231	0	0	0	13	W	OS	DET	0	0	0	2 FRAGS	1991	S
7-4	232	0	0	0	13	W	OS	INDET	0	0	0		1991	S
7-4	233	0	0	0	13	W	OS	DET	0	0	0	DENT CREMAT 2FR	1991	S
7-4	234	0	0	0	13	W	OS	INDET	0	0	0	2 FRAGS	1991	S
7-4	235	0	0	0	13	W	OS	DET	0	0	0	2 FRAGS	1991	S
7-4	236	0	0	0	13	W	OS	DET	0	0	0	CREMAT 2FRAGS	1991	S
7-4	237	0	0	0	13	W	OS	DET	0	0	0	CREMAT 3 FRAGS	1991	S
7-4	238	0	0	0	13	W	OS	DET	0	0	0	3 FRAGS	1991	S
7-4	239	0	0	0	12	W	OS	DET	0	0	0	CRA BOTA	1991	S
7-5	1	0	0	0	8	W	CERAMICA	INFORME	0	0	0		1991	S
7-5	2	0	0	0	8	E	QUARS	BPI	0	0	0		1991	S
7-5	3	0	0	0	8	E	ESQUIST	BNA	0	0	0	FRAG	1991	S
7-5	4	0	0	0	8	W	QUARS	BNA	0	0	0	FRAG	1991	S
7-6	1	0	0	0	4		CERAMICA	INFORME	0	0	0	SUPERFICIAL	1991	S
7-6	2	0	0	0	4		SILEX	BPF	0	0	0	SUPERFICIAL	1991	S
7-6	3	0	0	0	4		QUARS	BPF	0	0	0	SUPERFICIAL	1991	S
7-6	4	0	0	0	4		SILEX	BPF	0	0	0	SUPERFICIAL	1991	S
7-6	5	0	0	0	4	E	CERAMICA	INFORME	0	0	0		1991	S
7-6	6	0	0	0	4	E	CERAMICA	INFORME	0	0	0		1991	S
7-6	7	0	0	0	4	E	CERAMICA	INFORME	0	0	0		1991	S
7-6	8	0	0	0	4	E	CERAMICA	INFORME	0	0	0		1991	S
7-6	9	0	0	0	4	E	CERAMICA	INFORME	0	0	0		1991	S
7-6	10	0	0	0	4	E	QUARS	BP	0	0	0		1991	S
7-6	11	0	0	0	4	E	SILEX	BN2G	0	0	0		1991	S
7-6	12	0	0	0	4	W	CERAMICA	INFORME	0	0	0		1991	S
7-6	13	0	0	0	4	W	CERAMICA	INFORME	0	0	0		1991	S
7-6	14	0	0	0	4	W	CERAMICA	INFORME	0	0	0		1991	S
7-6	15	0	0	0	4	W	CERAMICA	INFORME	0	0	0		1991	S
7-6	16	0	0	0	4	W	CERAMICA	INFORME	0	0	0		1991	S
7-6	17	0	0	0	4	W	CERAMICA	INFORME	0	0	0		1991	S
7-6	18	0	0	0	4	W	CERAMICA	INFORME	0	0	0		1991	S
7-6	19	0	0	0	4	W	CERAMICA	INFORME	0	0	0		1991	S
7-6	20	0	0	0	4	W	CERAMICA	VORA	0	0	0		1991	S
7-6	21	0	0	0	4	W	QUARS	BPF	0	0	0		1991	S

BOBILA MADURELL  
MAS DURAN  
campanya 1991

E.E. NUM.	X	Y	Zsup	Zinf/ Talla	ORIENT	PENDENT SECTOR	MATERIA	OBJECTE	LONG	AMPL	ESPE	ALTERACIONS	P D
												OBSERVACIONS	ANY U I N B T U
7-6	22	0	0	0	4	E	RMI	BNA	0	0	0	FRAG	1991 S
7-6	23	0	0	0	4	E	SORRENCA	BNA	0	0	0	FRAG	1991 S
7-6	24	0	0	0	4	E	CALCARIA	BNA	0	0	0		1991 S
7-6	25	0	0	0	5	E	CERAMICA	INFORME	0	0	0		1991 S
7-6	26	0	0	0	5	E	CERAMICA	INFORME	0	0	0		1991 S
7-6	27	0	0	0	5	E	CERAMICA	INFORME	0	0	0		1991 S
7-6	28	0	0	0	5	E	CERAMICA	INFORME	0	0	0		1991 S
7-6	29	0	0	0	5	E	CERAMICA	INFORME	0	0	0		1991 S
7-6	30	0	0	0	5	W	CERAMICA	INFORME	0	0	0		1991 S
7-6	31	0	0	0	5	W	CERAMICA	INFORME	0	0	0		1991 S
7-6	32	0	0	0	5	W	CERAMICA	INFORME	0	0	0		1991 S
7-6	33	0	0	0	5	E	QUARS	BPF	0	0	0		1991 S
7-6	34	0	0	0	5	E	GRANIT	BNA	0	0	0	FRAG	1991 S
7-6	35	0	0	0	5	E	RMI	BNA	0	0	0	FRAC	1991 S
7-6	36	0	0	0	6	W	CERAMICA	INFORME	0	0	0		1991 S
7-6	37	0	0	0	6	W	QUARS	BPF	0	0	0		1991 S
7-6	38	0	0	0	6	E	QUARS	BNA	0	0	0	FRAG	1991 S
7-6	39	0	0	0	6	W	GRANIT	BNA	0	0	0	FRAG	1991 S
7-6	40	0	0	0	5	W	OS	INDET	0	0	0		1991 S
7-6	41	0	0	0	7	E	QUARS	BNA	0	0	0	FRAG	1991 S
7-6	42	0	0	0	7	E	QUARS	BNA	0	0	0	FRAG	1991 S
7-6	43	0	0	0	7	W	QUARS	BPF	0	0	0		1991 S
7-6	44	0	0	0	7	W	QUARS	BPF	0	0	0		1991 S
7-6	45	0	0	0	8	W	QUARS	BPF	0	0	0		1991 S
7-6	46	0	0	0	4	W	RMI	BNA	0	0	0	FRAG	1991 S
7-6	47	0	0	0	4	W	RMI	BNA	0	0	0	FRAC	1991 S
7-6	48	0	0	0	4	E	RMI	BNA	0	0	0		1991 S
7-6	49	0	0	0	4	E	OS	INDET	0	0	0		1991 S
7-7	1	0	0	2280	2475		OS	DET	0	0	0	FE D Lat Ant	1991 S
7-7	2	0	0	2400	2500		OS	DET	0	0	0	FE E Ant	1991 S
7-7	3	0	0	2367	2495		OS	DET	0	0	0	TI D Pos	1991 S
7-7	4	0	0	2338	2454		OS	DET	0	0	0	TI E Pos	1991 S
7-7	5	0	0	0	2454		OS	DET	0	0	0	TI E	1991 S
7-7	6	0	0	0	2500		SILEX	BP	0	0	0	LAMINA	1991 S
7-7	7	0	0	0	2498		SILEX	BP	0	0	0	LAMINA	1991 S
7-7	8	0	0	2391	2484		QUARS	BNA	0	0	0		1991 S
7-7	9	0	0	0	2501		SILEX	BN2G	0	0	0	PUNTA DE SAGETA	1991 S
7-7	10	0	0	0	2500		OS	INDET	0	0	0		1991 S
7-7	11	0	0	0	2473		OS	DET	0	0	0	HU E	1991 S
7-7	12	0	0	0	2520		OS	DET	0	0	0	RA E	1991 S
7-7	13	0	0	0	2520		OS	DET	0	0	0	CB E	1991 S
7-7	14	0	0	0	2520		OS	DET	0	0	0	CB D	1991 S
7-7	15	0	0	0	2520		OS	DET	0	0	0	RA D	1991 S
7-7	16	0	0	0	2530		OS	DET	0	0	0	HU D	1991 S
7-7	17	0	0	0	2500		OS	DET	0	0	0	MA E	1991 S
7-7	18	0	0	0	2530		OS	DET	0	0	0	MA E	1991 S
7-7	19	0	0	0	2543		OS	DET	0	0	0	CL D	1991 S
7-7	20	0	0	2464	2540		OS	DET	0	0	0	CRA	1991 S
7-7	21	0	0	0	2520		OS	BN2G	0	0	0	PUNXO	1991 S
7-7	22	0	0	2395	2484		OS	DET	0	0	0	PR D	1991 S
7-7	23	0	0	2482	2533		OS	DET	0	0	0	TM D	1991 S

BOBILA MADURELL  
MAS DURAN  
campanya 1991

E.E. NUM.	X	Y	Zsup	Zinf/ Talla	ORIENT	PENDENT SECTOR	MATERIA	OBJECTE	LONG	AMPL	ESPE	ALTERACIONS	P D
												OBSERVACIONS	ANY U I N B T U
7-7	24	0	0	0	2464		OS	DET	0	0	0	MD	1991 S
7-7	25	0	0	0	2464		OS	DET	0	0	0	MX	1991 S
7-7	26	0	0	0	2510		OS	DET	0	0	0	CST D	1991 S
7-7	27	0	0	0	2510		OS	DET	0	0	0	CST D	1991 S
7-7	28	0	0	0	2510		OS	DET	0	0	0		1991 S
7-7	29	0	0	0	2510		OS	DET	0	0	0	MC	1991 S
7-7	30	0	0	0	2488		OS	DET	0	0	0	E	1991 S
7-7	31	0	0	2592	2545		OS	DET	0	0	0	PEU D	1991 S
7-7	32	0	0	2519	2545		OS	DET	0	0	0	PEU E	1991 S
7-7	33	0	0	0	2445		OS	DET	0	0	0	CX D	1991 S
7-7	34	0	0	0	2486		OS	DET	0	0	0	CX E	1991 S
7-7	35	0	0	0	2513		OS	DET	0	0	0	CST D	1991 S
7-7	36	0	0	0	2510		OS	DET	0	0	0	CST E	1991 S
7-7	37	0	0	0	2493		OS	DET	0	0	0	EST	1991 S
7-7	38	0	0	0	2495		OS	DET	0	0	0	CL E	1991 S
7-7	39	0	0	0	2490		OS	DET	0	0	0	E E	1991 S
7-7	40	0	0	0	2489		OS	DET	0	0	0	E D	1991 S
7-7	41	0	0	0	0		OS	DET	0	0	0	VT CE	1991 S
7-7	42	0	0	0	2500		OS	DET	0	0	0	FRAG AST	1991 S
7-7	43	0	0	0	0		OS	DET	0	0	0	OSSOS MA	1991 S
7-7	44	0	0	2507	2546		OS	DET	0	0	0	OS MA E	1991 S
7-7	45	0	0	2520	2537		OS	DET	0	0	0	OS MA D	1991 S
7-7	46	0	0	0	0		OS	DET	0	0	0	VT CA/VT L	1991 S
7-7	47	0	0	0	0		OS	DET	0	0	0	VR CE/VT CA	1991 S
7-7	48	0	0	0	2400		OS	BN2G	0	0	0	PUNXO	1991 S
111	1	0	0	0	7	E	CERAMICA	INFORME	0	0	0		1991 S
111	2	0	0	0	7	E	CERAMICA	APLICA	0	0	0	MUGRO	1991 S
111	3	0	0	0	7	E	CERAMICA	INFORME	0	0	0		1991 S
111	4	0	0	0	7	E	CERAMICA	INFORME	0	0	0	VARIS FRAGS	1991 S
111	5	0	0	0	7	E	CERAMICA	INFORME	0	0	0		1991 S
111	6	0	0	0	7	W	TOVOT	FRAG	0	0	0		1991 S
111	7	0	0	0	7	W	CERAMICA	VORA	0	0	0		1991 S
111	8	0	0	0	7	W	CERAMICA	INFORME	0	0	0		1991 S
111	9	0	0	0	7	W	CERAMICA	INFORME	0	0	0		1991 S
111	10	0	0	0	7	W	CERAMICA	INFORME	0	0	0		1991 S
111	11	0	0	0	7	W	CERAMICA	INFORME	0	0	0		1991 S
111	12	0	0	0	7	W	CERAMICA	INFORME	0	0	0		1991 S
111	13	0	0	0	7	W	CERAMICA	INFORME	0	0	0		1991 S
111	14	0	0	0	0		CERAMICA	INFORME	0	0	0		1991 S
111	14	0	0	0	7	W	CERAMICA	CARENA	0	0	0		1991 S
111	15	0	0	0	7	W	CERAMICA	INFORME	0	0	0		1991 S
111	16	0	0	0	7	W	CERAMICA	INFORME	0	0	0		1991 S
111	17	0	0	0	7	W	CERAMICA	INFORME	0	0	0		1991 S
111	18	0	0	0	7	W	CERAMICA	INFORME	0	0	0		1991 S
111	19	0	0	0	7	W	CERAMICA	INFORME	0	0	0		1991 S
111	20	0	0	0	7	W	CERAMICA	APLICA	0	0	0	MUGRO	1991 S
111	21	0	0	0	7	W	CERAMICA	INFORME	0	0	0		1991 S
111	22	0	0	0	7	W	TOVOT	FRAG	0	0	0	VARIS FRAGS	1991 S
111	23	0	0	0	7	W	CERAMICA	INFORME	0	0	0		1991 S
111	24	0	0	0	7	W	TOVOT	FRAG	0	0	0		1991 S
111	25	0	0	0	7	W	CERAMICA	INFORME	0	0	0		1991 S

BOBILA MADURELL  
MAS DURAN  
campanya 1991

E.E. NUM.	X	Y	Zsup	Zinf/ Talla	ORIENT	PENDENT SECTOR	MATERIA	OBJECTE	LONG	AMPL	ESPE	ALTERACIONS	P D
												OBSERVACIONS	ANY U I N B T U
111	26	0	0	0	7	W	CERAMICA	VORA	0	0	0		1991 S
111	27	0	0	0	7	W	TOVOT	FRAG	0	0	0		1991 S
111	28	0	0	0	7	W	CERAMICA	VORA	0	0	0		1991 S
111	29	0	0	0	7	W	TOVOT	FRAG	0	0	0		1991 S
111	30	0	0	0	7	W	CERAMICA	INFORME	0	0	0	2 FRAGS	1991 S
111	31	0	0	0	6	E	CERAMICA	INFORME	0	0	0		1991 S
111	32	0	0	0	6	E	CERAMICA	INFORME	0	0	0		1991 S
111	33	0	0	0	6	E	CERAMICA	NANSA	0	0	0	2 FRAGS	1991 S
111	34	0	0	0	6	E	CERAMICA	APLICA	0	0	0	CORDO	1991 S
111	35	0	0	0	6	E	CERAMICA	INFORME	0	0	0	2 FRAGS	1991 S
111	36	0	0	0	6	E	CERAMICA	INFORME	0	0	0		1991 S
111	37	0	0	0	6	E	CERAMICA	INFORME	0	0	0		1991 S
111	38	0	0	0	6	E	CERAMICA	INFORME	0	0	0		1991 S
111	39	0	0	0	6	E	CERAMICA	NANSA	0	0	0		1991 S
111	40	0	0	0	6	W	TOVOT	FRAG	0	0	0	2 FRAGS	1991 S
111	41	0	0	0	6	W	CERAMICA	INFORME	0	0	0		1991 S
111	42	0	0	0	6	W	CERAMICA	INFORME	0	0	0		1991 S
111	43	0	0	0	6	W	CERAMICA	VORA	0	0	0		1991 S
111	44	0	0	0	6	W	CERAMICA	INFORME	0	0	0		1991 S
111	45	0	0	0	6	W	CERAMICA	INFORME	0	0	0		1991 S
111	46	0	0	0	6	W	CERAMICA	INFORME	0	0	0		1991 S
111	47	0	0	0	6	W	CERAMICA	INFORME	0	0	0		1991 S
111	48	0	0	0	6	W	CERAMICA	INFORME	0	0	0		1991 S
111	49	0	0	0	6	W	CERAMICA	INFORME	0	0	0		1991 S
111	50	0	0	0	6	W	CERAMICA	VORA	0	0	0		1991 S
111	51	0	0	0	6	W	CERAMICA	INFORME	0	0	0		1991 S
111	52	0	0	0	6	W	CERAMICA	INFORME	0	0	0	2 FRAGS	1991 S
111	53	0	0	0	6	W	CERAMICA	INFORME	0	0	0		1991 S
111	54	0	0	0	6	W	CERAMICA	INFORME	0	0	0		1991 S
111	55	0	0	0	6	W	CERAMICA	INFORME	0	0	0	3 FRAGS	1991 S
111	56	0	0	0	6	W	CERAMICA	INFORME	0	0	0		1991 S
111	57	0	0	0	6	W	CERAMICA	INFORME	0	0	0		1991 S
111	58	0	0	0	8	E	CERAMICA	INFORME	0	0	0		1991 S
111	59	0	0	0	8	E	CERAMICA	INFORME	0	0	0		1991 S
111	60	0	0	0	8	E	CERAMICA	INFORME	0	0	0	VARIS FRAGS	1991 S
111	61	0	0	0	8	E	CERAMICA	INFORME	0	0	0	VARIS FRAGS	1991 S
111	62	0	0	0	8	E	CERAMICA	INFORME	0	0	0	2 FRAGS	1991 S
111	63	0	0	0	8	E	CERAMICA	INFORME	0	0	0		1991 S
111	64	0	0	0	8	E	CERAMICA	INFORME	0	0	0	VARIS FRAGS	1991 S
111	65	0	0	0	8	E	CERAMICA	INFORME	0	0	0		1991 S
111	66	0	0	0	8	E	CERAMICA	INFORME	0	0	0		1991 S
111	67	0	0	0	8	E	CERAMICA	INFORME	0	0	0	VARIS FRAGS	1991 S
111	68	0	0	0	8	E	CERAMICA	INFORME	0	0	0		1991 S
111	69	0	0	0	8	E	CERAMICA	INFORME	0	0	0		1991 S
111	70	0	0	0	8	E	CERAMICA	VORA	0	0	0	DEC INTER INCIS	1991 S
111	71	0	0	0	8	W	CERAMICA	INFORME	0	0	0	2 FRAGS	1991 S
111	72	0	0	0	8	W	CERAMICA	INFORME	0	0	0		1991 S
111	73	0	0	0	8	W	CERAMICA	INFORME	0	0	0		1991 S
111	74	0	0	0	8	W	CERAMICA	INFORME	0	0	0		1991 S
111	75	0	0	0	8	W	TOVOT	FRAG	0	0	0		1991 S
111	76	0	0	0	8	W	CERAMICA	INFORME	0	0	0	VARIS FRAGS	1991 S



BOBILA MADURELL  
MAS DURAN  
campanya 1991

E.E. NUM.	X	Y	Zsup	Zinf/ Talla	ORIENT	PENDENT SECTOR	MATERIA	OBJECTE	LONG	AMPL	ALTERACIONS		P D	
											ESPE	OBSERVACIONS		ANY
													N B	
													T U	
111	77	0	0	0	8	W	CERAMICA	INFORME	0	0	0	VARIS FRAGS	1991	S
111	78	0	0	0	8	W	CERAMICA	INFORME	0	0	0		1991	S
111	79	0	0	0	8	W	CERAMICA	INFORME	0	0	0		1991	S
111	80	0	0	0	8	W	CERAMICA	INFORME	0	0	0		1991	S
111	81	0	0	0	8	W	TOVOT	FRAG	0	0	0	VARIS FRAGS	1991	S
111	82	0	0	0	8	W	CERAMICA	INFORME	0	0	0		1991	S
111	83	0	0	0	8	E	CERAMICA	INFORME	0	0	0		1991	S
111	84	0	0	0	9	E	CERAMICA	INFORME	0	0	0		1991	S
111	85	0	0	0	9	E	CERAMICA	INFORME	0	0	0	VARIS FRAGS	1991	S
111	86	0	0	0	9	E	CERAMICA	INFORME	0	0	0		1991	S
111	87	0	0	0	9	W	CERAMICA	INFORME	0	0	0		1991	S
111	88	0	0	0	9	W	CERAMICA	INFORME	0	0	0	VARIS FRAGS	1991	S
111	89	0	0	0	9	W	CERAMICA	INFORME	0	0	0		1991	S
111	90	0	0	0	9	W	CERAMICA	CARENA	0	0	0		1991	S
111	91	0	0	0	9	W	CERAMICA	INFORME	0	0	0		1991	S
111	92	0	0	0	9	W	CERAMICA	NANSA	0	0	0		1991	S
111	93	0	0	0	9	W	CERAMICA	INFORME	0	0	0		1991	S
111	94	0	0	0	10	E	CERAMICA	INFORME	0	0	0		1991	S
111	95	0	0	0	10	E	CERAMICA	INFORME	0	0	0	2 FRAGS	1991	S
111	96	0	0	0	10	E	CERAMICA	INFORME	0	0	0	2 FRAGS	1991	S
111	97	0	0	0	10	E	CERAMICA	INFORME	0	0	0		1991	S
111	98	0	0	0	10	W	CERAMICA	INFORME	0	0	0		1991	S
111	99	0	0	0	10	W	CERAMICA	INFORME	0	0	0		1991	S
111	100	0	0	0	10	W	CERAMICA	INFORME	0	0	0		1991	S
111	101	0	0	0	10	W	CERAMICA	INFORME	0	0	0	VARIS FRAGS	1991	S
111	102	0	0	0	10	W	CERAMICA	VORA	0	0	0		1991	S
111	103	0	0	0	10	W	CERAMICA	INFORME	0	0	0		1991	S
111	104	0	0	0	10	W	CERAMICA	INFORME	0	0	0		1991	S
111	105	0	0	0	7	W	CERAMICA	INFORME	0	0	0		1991	S
111	106	0	0	0	7	W	CERAMICA	INFORME	0	0	0		1991	S
111	107	0	0	0	7	W	CERAMICA	INFORME	0	0	0	VARIS FRAGS	1991	S
111	108	0	0	0	7	W	CERAMICA	INFORME	0	0	0		1991	S
111	109	0	0	0	7	W	CERAMICA	VORA	0	0	0		1991	S
111	110	0	0	0	7	W	CERAMICA	INFORME	0	0	0		1991	S
111	111	0	0	0	7	W	CERAMICA	INFORME	0	0	0		1991	S
111	112	0	0	0	7	W	CERAMICA	INFORME	0	0	0		1991	S
111	113	0	0	0	7	W	CERAMICA	INFORME	0	0	0	2 FRAGS	1991	S
111	114	0	0	0	7	W	CERAMICA	INFORME	0	0	0	2 FRAGS	1991	S
111	115	0	0	0	7	W	CERAMICA	INFORME	0	0	0		1991	S
111	116	0	0	0	7	W	CERAMICA	INFORME	0	0	0		1991	S
111	117	0	0	0	7	W	CERAMICA	INFORME	0	0	0		1991	S
111	118	0	0	0	7	W	CERAMICA	INFORME	0	0	0		1991	S
111	119	0	0	0	7	W	CERAMICA	INFORME	0	0	0		1991	S
111	120	0	0	0	7	W	CERAMICA	INFORME	0	0	0		1991	S
111	121	0	0	0	7	W	CERAMICA	INFORME	0	0	0		1991	S
111	122	0	0	0	7	W	CERAMICA	INFORME	0	0	0		1991	S
111	123	0	0	0	7	W	CERAMICA	INFORME	0	0	0		1991	S
111	124	0	0	0	7	W	CERAMICA	INFORME	0	0	0	VARIS FRAGS	1991	S
111	125	0	0	0	7	W	CERAMICA	INFORME	0	0	0		1991	S
111	126	0	0	0	7	W	CERAMICA	INFORME	0	0	0		1991	S
111	127	0	0	0	7	W	CERAMICA	INFORME	0	0	0		1991	S

BOBILA MADURELL  
MAS DURAN  
campanya 1991

E.E. NUM.	X	Y	Zsup	Zinf/ Talla	ORIENT	PENDENT SECTOR	MATERIA	OBJECTE	LONG	AMPL	ESPE	ALTERACIONS	P D
												OBSERVACIONS	
111	128	0	0	0	7	W	CERAMICA	INFORME	0	0	0	VARIS FRAGS	1991 S
111	129	0	0	0	7	W	CERAMICA	INFORME	0	0	0		1991 S
111	130	0	0	0	7	W	CERAMICA	INFORME	0	0	0		1991 S
111	131	0	0	0	11		CERAMICA	INFORME	0	0	0		1991 S
111	132	0	0	0	11	E	CERAMICA	INFORME	0	0	0		1991 S
111	132	0	0	0	11	E	CERAMICA	INFORME	0	0	0		1991 S
111	133	0	0	0	11	E	CERAMICA	INFORME	0	0	0		1991 S
111	134	0	0	0	11	E	CERAMICA	INFORME	0	0	0		1991 S
111	135	0	0	0	11	E	CERAMICA	INFORME	0	0	0	VARIS FRAGS	1991 S
111	136	0	0	0	11	W	CERAMICA	INFORME	0	0	0	VARIS FRAGS	1991 S
111	137	0	0	0	11	W	CERAMICA	VORA	0	0	0		1991 S
111	138	0	0	0	11	W	CERAMICA	INFORME	0	0	0		1991 S
111	139	0	0	0	11	W	CERAMICA	INFORME	0	0	0		1991 S
111	140	0	0	0	11	W	CERAMICA	INFORME	0	0	0		1991 S
111	141	0	0	0	11	W	CERAMICA	INFORME	0	0	0		1991 S
111	142	0	0	0	12	E	CERAMICA	INFORME	0	0	0		1991 S
111	143	0	0	0	13	E	CERAMICA	INFORME	0	0	0		1991 S
111	144	0	0	0	13	E	CERAMICA	INFORME	0	0	0		1991 S
111	145	0	0	0	13	E	CERAMICA	INFORME	0	0	0		1991 S
111	146	0	0	0	13	E	CERAMICA	INFORME	0	0	0		1991 S
111	147	0	0	0	13	W	CERAMICA	INFORME	0	0	0		1991 S
111	148	0	0	0	14	E	CERAMICA	INFORME	0	0	0		1991 S
111	149	0	0	0	14	E	CERAMICA	INFORME	0	0	0		1991 S
111	150	0	0	0	14	W	CERAMICA	VORA	0	0	0	3 FRAGS	1991 S
111	151	0	0	0	14	W	CERAMICA	INFORME	0	0	0		1991 S
111	152	0	0	0	14	W	CERAMICA	INFORME	0	0	0		1991 S
111	153	0	0	0	15	E	CERAMICA	INFORME	0	0	0		1991 S
111	154	0	0	0	15	E	CERAMICA	VORA	0	0	0		1991 S
111	155	0	0	0	15	E	CERAMICA	INFORME	0	0	0	VARIS FRAGS	1991 S
111	156	0	0	0	15	W	CERAMICA	INFORME	0	0	0		1991 S
111	157	0	0	0	15	W	CERAMICA	INFORME	0	0	0		1991 S
111	158	0	0	0	16		CERAMICA	INFORME	0	0	0		1991 S
111	159	0	0	0	16		CERAMICA	INFORME	0	0	0		1991 S
111	160	0	0	0	17	E	CERAMICA	VORA	0	0	0		1991 S
111	161	0	0	0	17	E	CERAMICA	INFORME	0	0	0		1991 S
111	162	0	0	0	17		CERAMICA	INFORME	0	0	0		1991 S
111	163	0	0	0	17		CERAMICA	INFORME	0	0	0		1991 S
111	164	0	0	0	17		CERAMICA	INFORME	0	0	0	3 FRAGS	1991 S
111	165	0	0	0	6	E	SILEX	BPF	0	0	0		1991 S
111	167	0	0	0	6	E	SILEX	BP	0	0	0		1991 S
111	168	0	0	0	6	W	SILEX	BPI	0	0	0		1991 S
111	169	0	0	0	7	W	SILEX	BPI	0	0	0		1991 S
111	170	0	0	0	8	E	SILEX	BN2G	0	0	0		1991 S
111	171	0	0	0	8	W	SILEX	BPF	0	0	0	DESHIDRATAT	1991 S
111	172	0	0	0	9	E	SILEX	BPI	0	0	0		1991 S
111	173	0	0	0	11	W	SILEX	BN2G	0	0	0	LAMINA CONCRECI	1991 S
111	174	0	0	0	6	E	SORRENCA	BNA	0	0	0	N.G. ALTERAT	1991 S
111	175	0	0	0	6	E	SORRENCA	BNA	0	0	0	FRAG ALTERAT	1991 S
111	176	0	0	0	6	E	RMI	BNA	0	0	0	FRAG	1991 S
111	177	0	0	0	6	E	CONGLOME	BNA	0	0	0	FRAG N.G.	1991 S
111	178	0	0	0	6	E	RMI	BNA	0	0	0	FRAG N.G.	1991 S

BOBILA MADURELL  
MAS DURAN  
campanya 1991

E.E. NUM.	X	Y	Zsup	Zinf/	ORIENT	PENDENT	MATERIA	OBJECTE	LONG	AMPL	ESPE	ALTERACIONS	P D
												OBSERVACIONS	ANY U I
												N B	T U
				Talla	SECTOR								
111	179	0	0	0	6	E	RMI	BNA	0	0	0	FRAG N.G.	1991 S
111	180	0	0	0	6	E	CONGLOME	BNA	0	0	0	FRAG N.G.	1991 S
111	181	0	0	0	6	E	CONGLOME	BNA	0	0	0	N.G.	1991 S
111	182	0	0	0	6	E	CONGLOME	BNE	0	0	0	FRAG MICROCONGL	1991 S
111	183	0	0	0	6	E	RMI	BNA	0	0	0	FRAG N.G.	1991 S
111	184	0	0	0	6	E	INDET	BNA	0	0	0	FRAG	1991 S
111	185	0	0	0	6	E	CALCARIA	BNA	0	0	0	FRAG	1991 S
111	186	0	0	0	6	E	RMI	BNA	0	0	0	FRAG N.G.	1991 S
111	187	0	0	0	6	E	INDET	BNA	0	0	0	FRAG	1991 S
111	188	0	0	0	6	E	QUARS	BNA	0	0	0	FRAC	1991 S
111	189	0	0	0	6	E	QUARS	BPI	0	0	0		1991 S
111	190	0	0	0	6	E	RMI	BNA	0	0	0	FRAG N.G.	1991 S
111	191	0	0	0	6	E	CALCARIA	BNA	0	0	0	FRAG N.G.	1991 S
111	192	0	0	0	6	E	RMI	BNA	0	0	0	FRAG N.G.	1991 S
111	193	0	0	0	6	E	CONGLOME	BNA	0	0	0	FRAG N.G.	1991 S
111	194	0	0	0	6	E	RMI	BNA	0	0	0	FRAG N.G.	1991 S
111	195	0	0	0	6	E	RMI	BNA	0	0	0	ALTERAT N.G.	1991 S
111	196	0	0	0	6	W	QUARS	BNA	0	0	0	FRAC	1991 S
111	197	0	0	0	6	W	QUARS	BNA	0	0	0	N.G.	1991 S
111	198	0	0	0	6	W	RMI	BNA	0	0	0	FRAG N.G.	1991 S
111	199	0	0	0	6	W	RMI	BNA	0	0	0	FRAG N.G.	1991 S
111	200	0	0	0	6	W	CONGLOME	BNA	0	0	0	N.G.	1991 S
111	201	0	0	0	6	W	QUARS	BNA	0	0	0	FRAG N.G.	1991 S
111	202	0	0	0	6	W	INDET	BNA	0	0	0	FRAG N.G.	1991 S
111	203	0	0	0	6	W	RMI	BNA	0	0	0	FRAG N.G.	1991 S
111	204	0	0	0	6	W	RMI	BNA	0	0	0	FRAG N.G.	1991 S
111	205	0	0	0	6	W	SORRENCA	BNA	0	0	0	ALTERAT N.G.	1991 S
111	206	0	0	0	6	W	QUARS	BNA	0	0	0	FRAC	1991 S
111	207	0	0	0	6	W	INDET	BNA	0	0	0	N.G.	1991 S
111	208	0	0	0	6	W	INDET	BNA	0	0	0	N.G.	1991 S
111	209	0	0	0	6	W	QUARSITA	BNA	0	0	0		1991 S
111	210	0	0	0	6	W	QUARS	BNA	0	0	0	FRAG N.G.	1991 S
111	211	0	0	0	6	W	INDET	BNA	0	0	0	ALTERAT	1991 S
111	212	0	0	0	6	W	RMI	BNA	0	0	0	FRAG N.G.	1991 S
111	213	0	0	0	6	W	RMI	BNA	0	0	0	FRAG	1991 S
111	214	0	0	0	6	W	RMI	BNA	0	0	0	FRAG N.G.	1991 S
111	215	0	0	0	6	W	RMI	BNE	0	0	0	FRAG	1991 S
111	216	0	0	0	6	W	RMI	BNA	0	0	0	N.G.	1991 S
111	217	0	0	0	6	W	QUARS	BNA	0	0	0	FRAC	1991 S
111	218	0	0	0	6	W	RMI	BNA	0	0	0	FRAG ALTERAT	1991 S
111	219	0	0	0	6	W	SILEX	BNA	0	0	0		1991 S
111	220	0	0	0	6	W	INDET	BNA	0	0	0	FRAG	1991 S
111	221	0	0	0	6	W	RMI	BNA	0	0	0	FRAG	1991 S
111	222	0	0	0	6	W	RMI	BNA	0	0	0	FRAG N.G.	1991 S
111	223	0	0	0	6	W	SORRENCA	BNA	0	0	0	FRAG N.G.	1991 S
111	224	0	0	0	6	W	QUARS	BNA	0	0	0	FRAG N.G.	1991 S
111	225	0	0	0	6	W	RMI	BNA	0	0	0	FRAG	1991 S
111	226	0	0	0	6	W	RMI	BNA	0	0	0	FRAG	1991 S
111	227	0	0	0	6	W	RMI	BNA	0	0	0	FRAG	1991 S
111	228	0	0	0	6	W	SORRENCA	BNA	0	0	0	FRAG N.G.	1991 S
111	229	0	0	0	6	W	RMI	BNA	0	0	0	FRAG N.G.	1991 S

BOBILA MADURELL  
MAS DURAN  
campanya 1991

E.E. NUM.	X	Y	Zsup	Zinf/ Talla	ORIENT	PENDENT SECTOR	MATERIA	OBJECTE	LONG	AMPL	ESPE	ALTERACIONS	P D
												OBSERVACIONS	ANY U I N B T U
111	230	0	0	0	6	W	CALCARIA	BNA	0	0	0	FRAG ALTERAT	1991 S
111	231	0	0	0	6	W	RMI	BNA	0	0	0	FRAG N.G.	1991 S
111	232	0	0	0	6	W	QUARS	BNA	0	0	0	FRAG N.G.	1991 S
111	233	0	0	0	6	W	RMI	BNA	0	0	0	FRAG N.G.	1991 S
111	234	0	0	0	6	W	RMI	BNA	0	0	0	FRAG N.G.	1991 S
111	235	0	0	0	6	W	RMI	BNA	0	0	0	FRAG N.G.	1991 S
111	236	0	0	0	6	W	CONGLOME	BNA	0	0	0	N.G.	1991 S
111	237	0	0	0	6	W	CONGLOME	BNA	0	0	0	FRAG N.G.	1991 S
111	238	0	0	0	6	W	RMI	BNE	0	0	0	FRAG	1991 S
111	239	0	0	0	6	W	QUARS	BNA	0	0	0	N.G.	1991 S
111	240	0	0	0	6	W	RMI	BNA	0	0	0	FRAG N.G.	1991 S
111	241	0	0	0	6	W	INDET	BNA	0	0	0	N.G.	1991 S
111	242	0	0	0	6	W	RMI	BNA	0	0	0	FRAG	1991 S
111	243	0	0	0	6	W	QUARS	BNA	0	0	0	FRAG N.G.	1991 S
111	244	0	0	0	6	W	SORRENCA	BNA	0	0	0	ALTERAT N.G.	1991 S
111	245	0	0	0	6	W	CALCARIA	BNA	0	0	0	ALTERAT	1991 S
111	246	0	0	0	6	W	SORRENCA	BNA	0	0	0	FRAG ALTERAT	1991 S
111	247	0	0	0	6	W	SORRENCA	BNA	0	0	0	ALTERAT N.G.	1991 S
111	248	0	0	0	6	W	CONGLOME	BNA	0	0	0	FRAG	1991 S
111	249	0	0	0	6	W	SORRENCA	BNA	0	0	0	FRAG ALTERAT	1991 S
111	250	0	0	0	6	W	RMI	BNA	0	0	0	ALTERAT N.G.	1991 S
111	251	0	0	0	6	W	ESQUIST	BNA	0	0	0	FRAG	1991 S
111	252	0	0	0	6	W	SORRENCA	BNA	0	0	0	ALTERAT N.G.	1991 S
111	253	0	0	0	6	W	CALCARIA	BNA	0	0	0	ALTERAT N.G.	1991 S
111	254	0	0	0	6	W	SORRENCA	BNA	0	0	0	ALTERAT N.G.	1991 S
111	255	0	0	0	6	W	RMI	BNE	0	0	0	FRAG	1991 S
111	256	0	0	0	6	W	QUARS	BNA	0	0	0	2 FRAGS	1991 S
111	257	0	0	0	7	E	QUARS	BNA	0	0	0	FRAC	1991 S
111	258	0	0	0	7	E	RMI	BNA	0	0	0	N.G.	1991 S
111	259	0	0	0	7	E	INDET	BNA	0	0	0	N.G.	1991 S
111	260	0	0	0	7	E	RMI	BNA	0	0	0	FRAG N.G.	1991 S
111	261	0	0	0	7	E	RMI	BNA	0	0	0	FRAG N.G.	1991 S
111	262	0	0	0	7	E	RMI	BNA	0	0	0	FRAG N.G.	1991 S
111	263	0	0	0	7	E	SORRENCA	BNA	0	0	0	FRAG N.G.	1991 S
111	264	0	0	0	7	E	QUARSITA	BNA	0	0	0	FRAG	1991 S
111	265	0	0	0	7	E	INDET	BNA	0	0	0	ALTERAT N.G.	1991 S
111	266	0	0	0	7	E	RMI	BNA	0	0	0	N.G.	1991 S
111	267	0	0	0	7	W	QUARS	BNA	0	0	0	FRAG N.G.	1991 S
111	268	0	0	0	7	W	RMI	BNA	0	0	0	N.G.	1991 S
111	269	0	0	0	7	W	RMI	BNA	0	0	0	FRAG N.G.	1991 S
111	270	0	0	0	7	W	QUARS	BNA	0	0	0	FRAG N.G.	1991 S
111	271	0	0	0	7	W	CALCARIA	BNA	0	0	0	FRAG ALTERAT NG	1991 S
111	272	0	0	0	7	W	RMI	BNA	0	0	0	FRAG N.G.	1991 S
111	273	0	0	0	7	W	QUARS	BNA	0	0	0	FRAG N.G.	1991 S
111	274	0	0	0	7	W	RMI	BNA	0	0	0	FRAG N.G.	1991 S
111	275	0	0	0	7	W	RMI	BNA	0	0	0	FRAG N.G.	1991 S
111	276	0	0	0	7	W	QUARS	BNA	0	0	0	FRAC	1991 S
111	277	0	0	0	7	W	QUARS	BNA	0	0	0	FRAG N.G.	1991 S
111	278	0	0	0	7	W	QUARS	BNA	0	0	0	FRAC	1991 S
111	279	0	0	0	7	W	RMI	BNA	0	0	0	FRAG	1991 S
111	280	0	0	0	7	W	QUARS	BNA	0	0	0	FRAG N.G.	1991 S

BOBILA MADURELL  
MAS DURAN  
campanya 1991

E.E. NUM.	X	Y	Zsup	Zinf/ Talla	ORIENT	PENDENT SECTOR	MATERIA	OBJECTE	LONG	AMPL	ESPE	ALTERACIONS OBSERVACIONS	P D				
													ANY	U	I	N B T U	
111	281	0	0	0	7	W	RMI	BNE	0	0	0	FRAG	1991	S			
111	282	0	0	0	7	W	RMI	BNA	0	0	0	FRAG N.G.	1991	S			
111	283	0	0	0	7	W	CONGLOME	BNA	0	0	0	FRAG N.G.	1991	S			
111	284	0	0	0	7	W	SORRENCA	BNA	0	0	0	FRAG ALTERAT	NG	1991	S		
111	285	0	0	0	7	W	RMI	BNA	0	0	0	FRAG N.G.	1991	S			
111	286	0	0	0	7	W	SORRENCA	BNA	0	0	0	ALTERAT N.G.	1991	S			
111	287	0	0	0	7	W	SORRENCA	BNA	0	0	0	N.G.	1991	S			
111	288	0	0	0	7	W	QUARS	BNA	0	0	0	FRAG N.G.	1991	S			
111	289	0	0	0	7	W	CALCARIA	BNA	0	0	0	ALTERAT N.G.	1991	S			
111	290	0	0	0	7	W	SORRENCA	BNA	0	0	0	FRAG ALTERAT	NG	1991	S		
111	291	0	0	0	7	W	CALCARIA	BNA	0	0	0	FRAG N.G.	1991	S			
111	292	0	0	0	7	W	RMI	BNA	0	0	0	FRAG N.G.	1991	S			
111	293	0	0	0	7	W	QUARS	BNA	0	0	0	FRAG N.G.	1991	S			
111	295	0	0	0	7	W	RMI	BNA	0	0	0	FRAG N.G.	1991	S			
111	296	0	0	0	7	W	RMI	BNE	0	0	0	FRAG	1991	S			
111	297	0	0	0	7	W	SORRENCA	BNA	0	0	0	FRAG N.G.	1991	S			
111	298	0	0	0	7	W	ESQUIST	BNA	0	0	0	FRAG N.G.	1991	S			
111	299	0	0	0	7	W	SORRENCA	BNA	0	0	0	ALTERAT N.G.	1991	S			
111	300	0	0	0	7	W	SORRENCA	BNA	0	0	0	ALTERAT N.G.	1991	S			
111	301	0	0	0	7	W	RMI	BNE	0	0	0	FRAG	1991	S			
111	302	0	0	0	7	W	INDET	BNA	0	0	0	ALTERAT N.G.	1991	S			
111	303	0	0	0	7	W	RMI	BNA	0	0	0	FRAG N.G.	1991	S			
111	304	0	0	0	7	W	CALCARIA	BNA	0	0	0	FRAC	1991	S			
111	305	0	0	0	7	W	QUARS	BNA	0	0	0	FRAG N.G.	1991	S			
111	306	0	0	0	7	W	CALCARIA	BNA	0	0	0	ALTERAT N.G.	1991	S			
111	307	0	0	0	7	W	RMI	BNA	0	0	0	FRAG N.G.	1991	S			
111	308	0	0	0	7	W	CONGLOME	BNA	0	0	0	FRAG N.G.	1991	S			
111	309	0	0	0	7	W	RMI	BNA	0	0	0	FRAG N.G.	1991	S			
111	310	0	0	0	7	W	RMI	BNE	0	0	0	FRAG	1991	S			
111	311	0	0	0	7	W	RMI	BNA	0	0	0	FRAG N.G.	1991	S			
111	312	0	0	0	7	W	SORRENCA	BNA	0	0	0	FRAG ALTERAT	NG	1991	S		
111	313	0	0	0	7	W	RMI	BNA	0	0	0	FRAG N.G.	1991	S			
111	314	0	0	0	7	W	SORRENCA	BNA	0	0	0	ALTERAT N.G.	1991	S			
111	315	0	0	0	7	W	RMI	BNA	0	0	0	FRAG N.G.	1991	S			
111	316	0	0	0	7	W	INDET	BNA	0	0	0	ALTERAT	1991	S			
111	317	0	0	0	7	W	SORRENCA	BNA	0	0	0	FRAG N.G.	1991	S			
111	318	0	0	0	7	W	RMI	BNA	0	0	0	FRAG N.G.	1991	S			
111	319	0	0	0	7	W	RMI	BNE	0	0	0	FRAG	1991	S			
111	320	0	0	0	7	W	RMI	BNA	0	0	0	FRAG N.G.	1991	S			
111	321	0	0	0	7	W	CONGLOME	BNA	0	0	0	FRAG N.G.	1991	S			
111	322	0	0	0	7	W	RMI	BNA	0	0	0	FRAG N.G.	1991	S			
111	323	0	0	0	7	W	SORRENCA	BNA	0	0	0	N.G.	1991	S			
111	324	0	0	0	7	W	RMI	BNA	0	0	0	FRAG	1991	S			
111	325	0	0	0	7	W	GRANIT	BNA	0	0	0	FRAG	1991	S			
111	326	0	0	0	7	W	SORRENCA	BNA	0	0	0	FRAG	1991	S			
111	327	0	0	0	7	W	SORRENCA	BNA	0	0	0	FRAG N.G.	1991	S			
111	328	0	0	0	7	W	CONGLOME	BNA	0	0	0	FRAG N.G.	1991	S			
111	329	0	0	0	7	W	SORRENCA	BNA	0	0	0	ALTERAT N.G.	1991	S			
111	330	0	0	0	7	W	CONGLOME	BNA	0	0	0	FRAG ALTERAT	1991	S			
111	331	0	0	0	7	W	SORRENCA	BNA	0	0	0		1991	S			
111	332	0	0	0	8	E	RMI	BNA	0	0	0	N.G.	1991	S			

BOBILA MADURELL  
MAS DURAN  
campanya 1991

E.E. NUM.	X	Y	Zsup	Zinf/ Talla	ORIENT	PENDENT SECTOR	MATERIA	OBJECTE	LONG	AMPL	ESPE	ALTERACIONS OBSERVACIONS	P D			
													ANY	U	I	N B
													T	U		
111	333	0	0	0	8	E	QUARS	BNA	0	0	0	FRAG N.G.	1991	S		
111	334	0	0	0	8	E	CONGLOME	BNE	0	0	0	FRAG	1991	S		
111	335	0	0	0	8	E	ESQUIST	BNA	0	0	0	N.G.	1991	S		
111	336	0	0	0	8	E	SORRENCA	BNA	0	0	0		1991	S		
111	337	0	0	0	8	E	RMI	BNA	0	0	0	FRAG N.G.	1991	S		
111	338	0	0	0	8	E	RMI	BNA	0	0	0	FRAG N.G.	1991	S		
111	339	0	0	0	8	E	CALCARIA	BNA	0	0	0	N.G.	1991	S		
111	340	0	0	0	8	W	SORRENCA	BNA	0	0	0	FRAG N.G.	1991	S		
111	341	0	0	0	8	W	SORRENCA	BNA	0	0	0		1991	S		
111	342	0	0	0	8	W	CONGLOME	BNA	0	0	0	FRAG	1991	S		
111	343	0	0	0	8	W	SORRENCA	BNA	0	0	0	FRAG N.G.	1991	S		
111	344	0	0	0	8	W	QUARS	BNA	0	0	0	FRAG N.G.	1991	S		
111	345	0	0	0	8	W	SORRENCA	BNE	0	0	0	FRAG	1991	S		
111	346	0	0	0	8	W	RMI	BNA	0	0	0	FRAG N.G.	1991	S		
111	347	0	0	0	8	W	ESQUIST	BNA	0	0	0	FRAG	1991	S		
111	348	0	0	0	8	W	RMI	BNE	0	0	0	FRAG	1991	S		
111	349	0	0	0	9	E	SORRENCA	BNA	0	0	0	N.G.	1991	S		
111	350	0	0	0	9	E	RMI	BNA	0	0	0	FRAG N.G.	1991	S		
111	351	0	0	0	9	E	RMI	BNA	0	0	0	FRAG N.G.	1991	S		
111	352	0	0	0	9	E	SORRENCA	BNA	0	0	0	FRAG N.G.	1991	S		
111	353	0	0	0	9	E	QUARS	BNA	0	0	0	N.G.	1991	S		
111	354	0	0	0	9	E	RMI	BNA	0	0	0	FRAG N.G.	1991	S		
111	355	0	0	0	9	W	QUARS	BNA	0	0	0	FRAG N.G.	1991	S		
111	356	0	0	0	9	W	QUARS	BNA	0	0	0	FRAG N.G.	1991	S		
111	357	0	0	0	9	W	RMI	BNA	0	0	0	FRAG N.G.	1991	S		
111	358	0	0	0	9	W	RMI	BNA	0	0	0	FRAG N.G.	1991	S		
111	359	0	0	0	9	W	QUARS	BNA	0	0	0	FRAG N.G.	1991	S		
111	360	0	0	0	9	W	SORRENCA	BNA	0	0	0	FRAG ALTERAT	NG	1991	S	
111	361	0	0	0	9	W	QUARS	BNA	0	0	0	FRAG N.G.	1991	S		
111	362	0	0	0	9	W	INDET	BNA	0	0	0	FRAG ALTERAT	1991	S		
111	363	0	0	0	9	W	RMI	BNA	0	0	0		1991	S		
111	364	0	0	0	9	W	RMI	BNA	0	0	0		1991	S		
111	365	0	0	0	10	E	QUARS	BNA	0	0	0	FRAG N.G.	1991	S		
111	366	0	0	0	10	E	RMI	BNA	0	0	0	FRAG N.G.	1991	S		
111	367	0	0	0	10	E	RMI	BNA	0	0	0	FRAG N.G.	1991	S		
111	368	0	0	0	10	E	QUARS	BNA	0	0	0	FRAG N.G.	1991	S		
111	369	0	0	0	10	E	CALCARIA	BNA	0	0	0	ALTERAT	1991	S		
111	370	0	0	0	10	W	CALCARIA	BNA	0	0	0	FRAG ALTERAT	1991	S		
111	371	0	0	0	10	W	QUARS	BNA	0	0	0	FRAG N.G.	1991	S		
111	372	0	0	0	10	W	GRANIT	BNE	0	0	0	FRAG MOLI	1991	S		
111	373	0	0	0	10	W	CALCARIA	BNA	0	0	0	FRAG ALTERAT	NG	1991	S	
111	374	0	0	0	10	W	INDET	BNA	0	0	0	N.G.	1991	S		
111	375	0	0	0	10	W	QUARS	BNA	0	0	0	FRAG N.G.	1991	S		
111	376	0	0	0	10	W	QUARS	BNA	0	0	0	FRAG	1991	S		
111	377	0	0	0	10	W	RMI	BNA	0	0	0	FRAG N.G.	1991	S		
111	378	0	0	0	11	E	QUARS	BNA	0	0	0	FRAG N.G.	1991	S		
111	379	0	0	0	11	E	QUARS	BNA	0	0	0	FRAG N.G.	1991	S		
111	380	0	0	0	11	E	CALCARIA	BNA	0	0	0	FRAG ALTERAT	1991	S		
111	381	0	0	0	11	W	SORRENCA	BNA	0	0	0	FRAG N.G.	1991	S		
111	382	0	0	0	11	W	SORRENCA	BNA	0	0	0	ALTERAT	1991	S		
111	383	0	0	0	11	W	RMI	BNA	0	0	0	FRAG N.G.	1991	S		

BOBILA MADURELL  
MAS DURAN  
campanya 1991

E.E. NUM.	X	Y	Zsup	Zinf/ Talla	ORIENT	PENDENT SECTOR	MATERIA	OBJECTE	LONG	AMPL	ESPE	ALTERACIONS	P D
												OBSERVACIONS	
111	384	0	0	0	11	W	QUARS	BNA	0	0	0	FRAG N.G.	1991 S
111	385	0	0	0	11	W	QUARSITA	BNA	0	0	0	FRAC	1991 S
111	386	0	0	0	11	W	RMI	BNA	0	0	0	FRAG N.G.	1991 S
111	387	0	0	0	12	W	RMI	BNA	0	0	0	FRAG N.G.	1991 S
111	388	0	0	0	15	E	QUARS	BNA	0	0	0	FRAG	1991 S
111	389	0	0	0	15	E	QUARS	BNA	0	0	0	FRAG	1991 S
111	390	0	0	0	15	W	RMI	BNA	0	0	0	N.G.	1991 S
111	391	0	0	0	15	W	RMI	BNA	0	0	0	FRAG N.G.	1991 S
111	392	0	0	0	15	W	RMI	BNA	0	0	0	POSSIBLE BNE	1991 S
111	393	0	0	0	16		SORRENCA	BNA	0	0	0	FRAG	1991 S
111	394	0	0	0	16		RMI	BNA	0	0	0	FRAG	1991 S
111	395	0	0	0	17		RMI	BNA	0	0	0	FRAG N.G.	1991 S
111	396	0	0	0	17		CALCARIA	BNA	0	0	0	FRAG	1991 S
111	397	0	0	0	18	W	CONGLOME	BNA	0	0	0	FRAG	1991 S
111	398	0	0	0	7	W	OS	INDET	0	0	0	2 FRAGS	1991 S
111	399	0	0	0	7	W	OS	INDET	0	0	0	2 FRAGS	1991 S
111	400	0	0	0	7	W	OS	DET	0	0	0	EI 3 FRAGS	1991 S
111	401	0	0	0	8	W	OS	INDET	0	0	0		1991 S
111	402	0	0	0	10	E	OS	DET	0	0	0	DENT	1991 S
111	403	0	0	0	10	E	OS	DET	0	0	0	DENT	1991 S
111	404	0	0	0	10	E	OS	DET	0	0	0	FRAG DENT	1991 S
111	405	0	0	0	10	E	OS	DET	0	0	0	FRAG DENT	1991 S
111	406	0	0	0	10	E	OS	DET	0	0	0	FRAG DENT	1991 S
111	407	0	0	0	10	W	OS	INDET	0	0	0		1991 S
111	408	0	0	0	10	W	OS	INDET	0	0	0		1991 S
111	409	0	0	0	10	W	OS	INDET	0	0	0		1991 S
111	410	0	0	0	10	W	OS	INDET	0	0	0		1991 S
111	411	0	0	0	10	W	OS	INDET	0	0	0		1991 S
111	412	0	0	0	11	E	OS	DET	0	0	0	EI V. FRAGS	1991 S
111	413	0	0	0	12	W	OS	INDET	0	0	0	VARIS FRAGS	1991 S
111	414	0	0	0	13	W	OS	DET	0	0	0	EI	1991 S
111	415	0	0	0	13	W	OS	DET	0	0	0	EI 2 FRAGS	1991 S
111	416	0	0	0	13	W	OS	DET	0	0	0	FRAG EI	1991 S
111	417	0	0	0	14	W	OS	DET	0	0	0	DENT	1991 S
111	418	0	0	0	15	E	OS	INDET	0	0	0		1991 S
111	419	0	0	0	15	E	OS	INDET	0	0	0		1991 S
111	420	0	0	0	15	E	OS	DET	0	0	0	FRAG CST	1991 S
111	421	0	0	0	15	E	OS	INDET	0	0	0		1991 S
111	422	0	0	0	15	W	OS	INDET	0	0	0		1991 S
111	423	0	0	0	15	W	OS	INDET	0	0	0		1991 S
111	424	0	0	0	17		OS	DET	0	0	0	DENT	1991 S
111	425	0	0	0	17		OS	DET	0	0	0	EI	1991 S
111	426	0	0	0	17		OS	INDET	0	0	0		1991 S
111	427	0	0	0	18	E	OS	INDET	0	0	0		1991 S
111	428	0	0	0	18	E	OS	INDET	0	0	0		1991 S
111	429	0	0	0	10		ORGANIC	MOLUSC	0	0	0	PERFORAT	1991 S
111	430	0	0	0	9	W	OCRE	FRAG	0	0	0		1991 S
111	431	0	0	0	6	E	QUARS	BNA	0	0	0	FRAG N.G.	1991 S
111	432	0	0	0	6	E	RMI	BNA	0	0	0	FRAG N.G.	1991 S
111	433	0	0	0	6	E	QUARS	BNA	0	0	0	N.G.	1991 S
111	434	0	0	0	6	E	QUARS	BNA	0	0	0	FRAG N.G.	1991 S

BOBILA MADURELL  
MAS DURAN  
campanya 1991

E.E. NUM.	X	Y	Zsup	Zinf/ Talla	ORIENT	PENDENT SECTOR	MATERIA	OBJECTE	LONG	AMPL	ESPE	ALTERACIONS OBSERVACIONS	P D			
													ANY	U	I	N B
													T	U		
111	435	0	0	0	6	E	RMI	BNA	0	0	0	N.G.	1991	S		
111	436	0	0	0	6	E	RMI	BNA	0	0	0	FRAG N.G.	1991	S		
111	437	0	0	0	6	E	RMI	BNA	0	0	0	N.G.	1991	S		
111	438	0	0	0	6	E	QUARS	BNA	0	0	0	FRAG N.G.	1991	S		
111	439	0	0	0	6	E	INDET	BNA	0	0	0	N.G.	1991	S		
111	440	0	0	0	6	E	RMI	BNE	0	0	0	FRAG	1991	S		
111	441	0	0	0	6	E	SORRENCA	BNA	0	0	0	FRAG	1991	S		
111	442	0	0	0	6	E	QUARS	BNA	0	0	0	FRAG	1991	S		
111	443	0	0	0	6	E	CONGLOME	BNE	0	0	0	FRAG MOLI	1991	S		
111	444	0	0	0	6	E	SORRENCA	BNA	0	0	0	FRAG N.G.	1991	S		
111	445	0	0	0	7	E	RMI	BNA	0	0	0	FRAG N.G.	1991	S		
111	446	0	0	0	7	E	QUARS	BNA	0	0	0	FRAG	1991	S		
111	447	0	0	0	7	E	RMI	BNA	0	0	0	FRAG N.G.	1991	S		
111	448	0	0	0	7	E	QUARS	BNA	0	0	0	FRAG N.G.	1991	S		
111	449	0	0	0	7	W	RMI	BNE	0	0	0	FRAG MOLI	1991	S		
111	450	0	0	0	7	W	GRANIT	BNE	0	0	0	FRAG	1991	S		
111	451	0	0	0	7	W	CONGLOME	BNE	0	0	0	FRAG MOLI	1991	S		
111	452	0	0	0	7	W	RMI	BNA	0	0	0	FRAG N.G.	1991	S		
111	453	0	0	0	7	W	SORRENCA	BNA	0	0	0	N.G.	1991	S		
111	454	0	0	0	8	E	CONGLOME	BNE	0	0	0	FRAG MOLI	1991	S		
111	455	0	0	0	8	E	CONGLOME	BNE	0	0	0	FRAG MOLI	1991	S		
111	456	0	0	0	8	E	RMI	BNE	0	0	0	FRAG	1991	S		
111	457	0	0	0	8	E	RMI	BNA	0	0	0	FRAG N.G.	1991	S		
111	458	0	0	0	8	E	SORRENCA	BNA	0	0	0	FRAG N.G.	1991	S		
111	459	0	0	0	15	W	SORRENCA	BNA	0	0	0	FRAG N.G.	1991	S		
111	460	0	0	0	17	E	INDET	BNA	0	0	0	N.G.	1991	S		
13	1	0	0	0	6	E	CERAMICA	INFORME	0	0	0		1991	S		
13	2	0	0	0	6	E	CERAMICA	INFORME	0	0	0		1991	S		
13	3	0	0	0	6	E	CERAMICA	INFORME	0	0	0		1991	S		
13	4	0	0	0	6	E	RMI	BNA	0	0	0	FRAG	1991	S		
13	5	0	0	0	6	E	QUARS	BNA	0	0	0	FRAG	1991	S		
13	6	0	0	0	7		CERAMICA	VORA	0	0	0		1991	S		
13	7	0	0	0	8	E	CERAMICA	NANSA	0	0	0		1991	S		
13	8	0	0	0	8	E	CERAMICA	INFORME	0	0	0		1991	S		
13	9	0	0	0	8	E	CERAMICA	VORA	0	0	0		1991	S		
13	10	0	0	0	8	E	CERAMICA	INFORME	0	0	0		1991	S		
13	11	0	0	0	8	E	CERAMICA	INFORME	0	0	0		1991	S		
13	12	0	0	0	8	E	CERAMICA	INFORME	0	0	0		1991	S		
13	13	0	0	0	8	E	CERAMICA	INFORME	0	0	0		1991	S		
13	14	0	0	0	8	E	CERAMICA	INFORME	0	0	0		1991	S		
13	15	0	0	0	8	E	CERAMICA	VORA	0	0	0		1991	S		
13	16	0	0	0	8	E	CERAMICA	VORA	0	0	0		1991	S		
13	17	0	0	0	8	E	QUARS	BPF	0	0	0		1991	S		
13	18	0	0	0	8	E	QUARS	BP2G	0	0	0		1991	S		
13	19	0	0	0	8	E	QUARS	BPF	0	0	0		1991	S		
13	20	0	0	0	8	E	RMI	BNA	0	0	0	FRAG	1991	S		
13	21	0	0	0	8	E	RMI	BNA	0	0	0	FRAC	1991	S		
13	22	0	0	0	8	E	GRANIT	BNA	0	0	0	FRAG	1991	S		
13	23	0	0	0	8	E	RMI	BNA	0	0	0		1991	S		
13	24	0	0	0	8	E	CONGLOME	PLAQUETA	0	0	0	FRAC	1991	S		
13	25	0	0	0	8	W	CALCARIA	BNA	0	0	0	FRAG	1991	S		



BOBILA MADURELL  
MAS DURAN  
campanya 1991

E.E. NUM.	X	Y	Zsup	Zinf/ Talla	ORIENT	PENDENT SECTOR	MATERIA	OBJECTE	LONG	AMPL	ESPE	ALTERACIONS	P D
												OBSERVACIONS	
13	26	0	0	0	8	W	QUARS	BNA	0	0	0	FRAG	1991 S
13	27	0	0	0	8	W	QUARS	BNA	0	0	0	FRAC	1991 S
13	28	0	0	0	9		CERAMICA	INFORME	0	0	0		1991 S
13	29	0	0	0	9		CERAMICA	INFORME	0	0	0		1991 S
13	30	0	0	0	9		CERAMICA	INFORME	0	0	0		1991 S
13	31	0	0	0	9		SILEX	BPF	0	0	0	LAMINA	1991 S
14	1	0	0	0	7		CERAMICA	INFORME	0	0	0		1991 S
14	2	0	0	0	7		CERAMICA	INFORME	0	0	0		1991 S
14	3	0	0	0	7		CERAMICA	INFORME	0	0	0		1991 S
14	4	0	0	0	7		CERAMICA	INFORME	0	0	0		1991 S
14	5	0	0	0	7		CERAMICA	INFORME	0	0	0		1991 S
14	6	0	0	0	7		CERAMICA	INFORME	0	0	0		1991 S
14	7	0	0	0	7		CERAMICA	INFORME	0	0	0		1991 S
14	8	0	0	0	7		CERAMICA	INFORME	0	0	0		1991 S
14	9	0	0	0	7		CERAMICA	VORA	0	0	0		1991 S
14	10	0	0	0	7		CERAMICA	NANSA	0	0	0		1991 S
14	11	0	0	0	7		CERAMICA	INFORME	0	0	0		1991 S
14	12	0	0	0	7		CERAMICA	VAS	0	0	0	VARIS FRAGS	1991 S
14	13	0	0	0	7		CERAMICA	INFORME	0	0	0		1991 S
14	14	0	0	0	7		CERAMICA	INFORME	0	0	0		1991 S
14	15	0	0	0	7		CERAMICA	VORA	0	0	0		1991 S
14	16	0	0	0	7		CERAMICA	APLICA	0	0	0		1991 S
14	17	0	0	0	7		CERAMICA	INFORME	0	0	0		1991 S
14	18	0	0	0	7		CERAMICA	INFORME	0	0	0		1991 S
14	19	0	0	0	7		CERAMICA	INFORME	0	0	0		1991 S
14	20	0	0	0	7		CERAMICA	INFORME	0	0	0		1991 S
14	21	0	0	0	7		CERAMICA	INFORME	0	0	0		1991 S
14	22	0	0	0	7		CERAMICA	INFORME	0	0	0		1991 S
14	23	0	0	0	7		QUARS	BP2G	0	0	0		1991 S
14	24	0	0	0	7		SILEX	BPF	0	0	0		1991 S
14	25	0	0	0	7		QUARS	BP2G	0	0	0		1991 S
14	26	0	0	0	7		SILEX	BPF	0	0	0		1991 S
14	27	0	0	0	7		SILEX	BPF	0	0	0		1991 S
14	28	0	0	0	7		ESQUIST	BNA	0	0	0	FRAG	1991 S
14	29	0	0	0	7		ESQUIST	BNA	0	0	0	FRAG	1991 S
14	30	0	0	0	7		QUARS	BNA	0	0	0	FRAG	1991 S
14	31	0	0	0	7		GRANIT	BNA	0	0	0	FRAG	1991 S
14	32	0	0	0	7		RMI	BNA	0	0	0	FRAG	1991 S
14	33	0	0	0	7		GRANIT	BNA	0	0	0	FRAG	1991 S
14	34	0	0	0	7		RMI	BNA	0	0	0	FRAC	1991 S
14	35	0	0	0	7		CONGLOME	BNA	0	0	0	FRAG	1991 S
14	36	0	0	0	7		RMI	BNA	0	0	0		1991 S
14	37	0	0	0	7		CONGLOME	BNA	0	0	0	FRAG	1991 S
14	38	0	0	0	7		CERAMICA	INFORME	0	0	0		1991 S
15	1	0	0	0	825		OS	DET	0	0	0		1991 S
15	2	0	0	0	844		OS	DET	0	0	0		1991 S
15	3	0	0	0	841		OS	INDET	0	0	0		1991 S
15	4	0	0	0	827		OS	INDET	0	0	0		1991 S
15	5	0	0	0	821		OS	DET	0	0	0		1991 S
15	6	0	0	0	821		OS	INDET	0	0	0		1991 S
15	7	0	0	0	812		OS	INDET	0	0	0		1991 S

BOBILA MADURELL  
MAS DURAN  
campanya 1991

E.E. NUM.	X	Y	Zsup	Zinf/ Talla	ORIENT	PENDENT SECTOR	MATERIA	OBJECTE	LONG	AMPL	ESPE	ALTERACIONS	P D
												OBSERVACIONS	ANY U I N B T U
15	8	0	0	0	810		OS	INDET	0	0	0		1991 S
15	9	0	0	0	824		OS	DET	0	0	0	MD Inf	1991 S
15	10	0	0	0	834		OS	DET	0	0	0	VARIS FRAGS	1991 S
15	11	0	0	0	800		CERAMICA	INFORME	0	0	0	VARIS FRAGS	1991 S
15	12	0	0	0	809		OS	DET	0	0	0	MD Sup	1991 S
15	13	0	0	0	810		OS	INDET	0	0	0	VARIS FRAGS	1991 S
16	1	0	0	0	9		CERAMICA	INFORME	0	0	0		1991 S
16	2	0	0	0	9		CERAMICA	INFORME	0	0	0		1991 S
16	3	0	0	0	9	E	SILEX	BPF	0	0	0		1991 S
16	4	0	0	0	9	E	SILEX	BN2G	0	0	0		1991 S
16	5	0	0	0	9		OS	INDET	0	0	0		1991 S
16	6	0	0	0	9	E	OS	DET	0	0	0	DENT	1991 S
16	7	0	0	0	10	E	CERAMICA	VORA	0	0	0		1991 S
16	8	0	0	0	10	W	CERAMICA	VORA	0	0	0		1991 S
16	9	0	0	0	10	W	CERAMICA	INFORME	0	0	0		1991 S
16	10	0	0	0	10	W	CERAMICA	VORA	0	0	0		1991 S
16	11	0	0	0	10	W	CERAMICA	INFORME	0	0	0		1991 S
16	12	0	0	0	10	W	CERAMICA	VORA	0	0	0		1991 S
16	13	0	0	0	10	W	CERAMICA	INFORME	0	0	0		1991 S
16	14	0	0	0	10	W	CERAMICA	INFORME	0	0	0		1991 S
16	15	0	0	0	10	E	OS	INDET	0	0	0		1991 S
16	16	0	0	0	10	E	OS	INDET	0	0	0		1991 S
16	17	0	0	0	10	E	OS	INDET	0	0	0		1991 S
16	18	0	0	0	10	E	OS	DET	0	0	0		1991 S
16	19	0	0	0	10	E	SILEX	BP	0	0	0		1991 S
16	20	0	0	0	10	E	SILEX	BN2G	0	0	0	LAMINA	1991 S
16	21	0	0	0	10	E	SILEX	BN2G	0	0	0		1991 S
16	22	0	0	0	10	E	SILEX	BP	0	0	0		1991 S
16	23	0	0	0	10	E	SILEX	BN2G	0	0	0	LAMINA	1991 S
16	24	0	0	0	10	E	SILEX	BP	0	0	0	TRAPECI	1991 S
16	25	0	0	0	10	E	SILEX	BN2G	0	0	0	LAMINA	1991 S
16	26	0	0	0	10	E	SILEX	BPF	0	0	0		1991 S
16	27	0	0	0	10	W	SILEX	BP	0	0	0	LAMINA	1991 S
16	28	0	0	0	10	W	QUARSITA	BN2G	0	0	0	DESTRAL	1991 S
16	29	0	0	0	10	W	ESQUIST	BNA	0	0	0	FRAG	1991 S
16	30	0	0	0	10	W	CALCARIA	BNA	0	0	0		1991 S
16	31	0	0	0	10	W	RMI	BNA	0	0	0	FRAG	1991 S
16	32	0	0	0	10	W	CERAMICA	INFORME	0	0	0		1991 S
16	33	0	0	0	10	W	ORGANIC	MOLUSC	0	0	0	POLIT	1991 S
16	34	0	0	0	11	E	SILEX	BPF	0	0	0	FRAG LAMINA	1991 S
16	35	0	0	0	9		OS	BN2G	0	0	0	PUNXO	1991 S
17	1	0	0	0	9	E	CERAMICA	INFORME	0	0	0		1991 S
17	2	0	0	0	9	E	CERAMICA	INFORME	0	0	0		1991 S
17	3	0	0	0	9	E	CERAMICA	VORA	0	0	0		1991 S
17	4	0	0	0	9	E	CERAMICA	INFORME	0	0	0		1991 S
17	5	0	0	0	9	W	CERAMICA	INFORME	0	0	0		1991 S
17	6	0	0	0	9	W	CERAMICA	VORA	0	0	0	APLICACIO	1991 S
17	7	0	0	0	9	E	OS	INDET	0	0	0	CREMAT	1991 S
17	8	0	0	0	9	E	OS	INDET	0	0	0		1991 S
17	9	0	0	0	9	E	OS	INDET	0	0	0		1991 S
17	10	0	0	0	9	E	OS	INDET	0	0	0		1991 S

BOBILA MADURELL  
MAS DURAN  
campanya 1991

E.E. NUM.	X	Y	Zsup	Zinf/ Talla	ORIENT	PENDENT SECTOR	MATERIA	OBJECTE	LONG	AMPL	ESPE	ALTERACIONS OBSERVACIONS	P	D
													ANY	U
17	11	0	0	0	9	E	OS	INDET	0	0	0	CREMAT	1991	S
17	12	0	0	0	9	E	OS	INDET	0	0	0		1991	S
17	13	0	0	0	9	E	OS	DET	0	0	0	VARIS FRAGS	1991	S
17	14	0	0	0	9	W	OS	INDET	0	0	0	CREMAT	1991	S
17	15	0	0	0	9	E	RMI	BNA	0	0	0	FRAG	1991	S
17	16	0	0	0	9	E	QUARS	BNA	0	0	0		1991	S
17	17	0	0	0	9	E	QUARS	BNA	0	0	0		1991	S
17	18	0	0	0	9	E	RMI	BNA	0	0	0	FRAG	1991	S
17	19	0	0	0	9	E	SORRENCA	BNA	0	0	0	FRAG	1991	S
17	20	0	0	0	9	E	CONGLOME	BNA	0	0	0	FRAG	1991	S
17	21	0	0	0	9	E	ESQUIST	BNA	0	0	0	FRAG	1991	S
17	22	0	0	0	9	E	GRANIT	BNA	0	0	0	FRAG	1991	S
17	23	0	0	0	9	E	CALCARIA	BNA	0	0	0	FRAG	1991	S
17	24	0	0	0	10	E	CERAMICA	INFORME	0	0	0		1991	S
17	25	0	0	0	10	E	CERAMICA	INFORME	0	0	0		1991	S
17	26	0	0	0	10	E	CERAMICA	INFORME	0	0	0		1991	S
17	27	0	0	0	10	E	TOVOT	FRAG	0	0	0		1991	S
17	28	0	0	0	10	E	CERAMICA	VORA	0	0	0	VARIS FRAGS	1991	S
17	29	0	0	0	10	W	CERAMICA	INFORME	0	0	0		1991	S
17	30	0	0	0	10	W	CERAMICA	INFORME	0	0	0		1991	S
17	31	0	0	0	10	W	CERAMICA	INFORME	0	0	0		1991	S
17	32	0	0	0	10	W	TOVOT	FRAG	0	0	0		1991	S
17	33	0	0	0	10	W	CERAMICA	APLICA	0	0	0		1991	S
17	34	0	0	0	10	W	CERAMICA	VORA	0	0	0		1991	S
17	35	0	0	0	10	W	CERAMICA	INFORME	0	0	0		1991	S
17	36	0	0	0	10	W	CERAMICA	INFORME	0	0	0		1991	S
17	37	0	0	0	10	W	CERAMICA	INFORME	0	0	0		1991	S
17	38	0	0	0	10	E	OS	INDET	0	0	0		1991	S
17	39	0	0	0	10	E	OS	INDET	0	0	0	CREMAT	1991	S
17	40	0	0	0	10	E	OS	DET	0	0	0		1991	S
17	41	0	0	0	10	E	OS	INDET	0	0	0	CREMAT	1991	S
17	42	0	0	0	10	E	OS	DET	0	0	0		1991	S
17	43	0	0	0	10	E	OS	INDET	0	0	0		1991	S
17	44	0	0	0	10	E	OS	INDET	0	0	0		1991	S
17	45	0	0	0	10	E	OS	INDET	0	0	0		1991	S
17	46	0	0	0	10	W	OS	INDET	0	0	0		1991	S
17	47	0	0	0	10	W	OS	INDET	0	0	0		1991	S
17	48	0	0	0	10	W	OS	INDET	0	0	0		1991	S
17	49	0	0	0	10	W	OS	INDET	0	0	0		1991	S
17	50	0	0	0	10	W	OS	DET	0	0	0		1991	S
17	51	0	0	0	10	E	SILEX	BN2G	0	0	0	LAMINA	1991	S
17	52	0	0	0	10	W	QUARS	BPF	0	0	0		1991	S
17	53	0	0	0	10	W	SILEX	BN2G	0	0	0	TRAPECI	1991	S
17	54	0	0	0	10	E	RMI	BNA	0	0	0	FRAG	1991	S
17	55	0	0	0	10	E	CALCARIA	BNA	0	0	0	FRAG	1991	S
17	56	0	0	0	10	E	RMI	BNA	0	0	0	FRAG	1991	S
17	57	0	0	0	10	E	RMI	BNA	0	0	0	FRAG	1991	S
17	58	0	0	0	10	W	RMI	BNA	0	0	0	FRAG	1991	S
17	59	0	0	0	10	W	CALCARIA	BNA	0	0	0	FRAG	1991	S
17	60	0	0	0	11	E	TOVOT	FRAG	0	0	0		1991	S
17	61	0	0	0	11	E	TOVOT	FRAG	0	0	0		1991	S

BOBILA MADURELL  
MAS DURAN  
campanya 1991

E.E. NUM.	X	Y	Zsup	Zinf/ Talla	ORIENT	PENDENT SECTOR	MATERIA	OBJECTE	LONG	AMPL	ESPE	ALTERACIONS	P D
												OBSERVACIONS	ANY U I N B T U
17	62	0	0	0	11	E	TOVOT	FRAG	0	0	0		1991 S
17	63	0	0	0	11	E	TOVOT	FRAG	0	0	0		1991 S
17	64	0	0	0	11	E	CERAMICA	VORA	0	0	0	APLICA	1991 S
17	65	0	0	0	11	W	CERAMICA	INFORME	0	0	0		1991 S
17	66	0	0	0	11	W	CERAMICA	APLICA	0	0	0		1991 S
17	67	0	0	0	11	W	CERAMICA	INFORME	0	0	0		1991 S
17	68	0	0	0	11	W	CERAMICA	INFORME	0	0	0		1991 S
17	69	0	0	0	11	W	TOVOT	FRAG	0	0	0		1991 S
17	70	0	0	0	11	W	TOVOT	FRAG	0	0	0		1991 S
17	71	0	0	0	11	W	TOVOT	FRAG	0	0	0		1991 S
17	72	0	0	0	11	W	CERAMICA	INFORME	0	0	0		1991 S
17	73	0	0	0	11	W	CERAMICA	INFORME	0	0	0		1991 S
17	74	0	0	0	11	W	CERAMICA	INFORME	0	0	0		1991 S
17	75	0	0	0	11		TOVOT	FRAG	0	0	0		1991 S
17	76	0	0	0	11	E	OS	BN2G	0	0	0	PUNXO CREMAT	1991 S
17	77	0	0	0	11	E	OS	INDET	0	0	0	CREMAT	1991 S
17	78	0	0	0	11	E	OS	INDET	0	0	0		1991 S
17	79	0	0	0	11	E	OS	INDET	0	0	0		1991 S
17	80	0	0	0	11	E	OS	INDET	0	0	0	CREMAT	1991 S
17	81	0	0	0	11	W	OS	INDET	0	0	0		1991 S
17	82	0	0	0	11	W	OS	DET	0	0	0		1991 S
17	83	0	0	0	11	W	OS	INDET	0	0	0		1991 S
17	84	0	0	0	11	W	OS	INDET	0	0	0		1991 S
17	85	0	0	0	11	W	OS	INDET	0	0	0		1991 S
17	86	0	0	0	11	E	GRANIT	BNA	0	0	0	FRAC MOLI	1991 S
17	87	0	0	0	11	E	ESQUIST	BNA	0	0	0	FRAG	1991 S
17	88	0	0	0	11	E	RMI	BNA	0	0	0	FRAG	1991 S
17	89	0	0	0	11	E	QUARSITA	BNA	0	0	0	POLIT?	1991 S
17	90	0	0	0	11	E	RMI	BNA	0	0	0	FRAG	1991 S
17	91	0	0	0	11	E	RMI	BNA	0	0	0	FRAC MOLI	1991 S
17	93	0	0	0	11	W	CONGLOME	BNA	0	0	0	FRAG	1991 S
17	94	0	0	0	11	W	RMI	BNA	0	0	0	FRAG	1991 S
17	95	0	0	0	11	W	QUARS	BNA	0	0	0	FRAG	1991 S
17	96	0	0	0	11	W	QUARS	BNA	0	0	0	FRAG	1991 S
17	97	0	0	0	11	W	QUARSITA	BNA	0	0	0	FRAG	1991 S
17	98	0	0	0	11	W	QUARS	BNA	0	0	0	FRAG	1991 S
17	99	0	0	0	11	W	OS	INDET	0	0	0	POLIT	1991 S
17	100	0	0	0	12	W	CERAMICA	INFORME	0	0	0		1991 S
17	101	0	0	0	12	W	CERAMICA	VORA	0	0	0		1991 S
17	102	0	0	0	12	E	OS	BN2G	0	0	0	FRAG PUNXO CREM	1991 S
17	103	0	0	0	12	E	OS	INDET	0	0	0	CREMAT	1991 S
17	104	0	0	0	12	E	OS	INDET	0	0	0	CREMAT	1991 S
17	105	0	0	0	12	E	OS	INDET	0	0	0	CREMAT	1991 S
17	106	0	0	0	13	W	CERAMICA	CARENA	0	0	0		1991 S
17	107	0	0	0	12	E	SILEX	BP2G	0	0	0		1991 S
17	108	0	0	0	12	E	CALCARIA	BP	0	0	0		1991 S
17	109	0	0	0	12	E	CALCARIA	BP	0	0	0		1991 S
17	110	0	0	0	12	E	SILEX	BP	0	0	0		1991 S
17	111	0	0	0	12	W	SILEX	BN2G	0	0	0	PATINAT	1991 S
17	112	0	0	0	13	E	SILEX	BPF	0	0	0		1991 S
17	113	0	0	0	13	E	SILEX	BP	0	0	0		1991 S

BOBILA MADURELL  
MAS DURAN  
campanya 1991

E.E. NUM.	X	Y	Zsup	Zinf/	Talla	ORIENT	PENDENT	MATERIA	OBJECTE	LONG	AMPL	ESPE	ALTERACIONS	P D
													OBSERVACIONS	ANY U I
													N B	T U
17	114	0	0	0	13	E		SILEX	BP2G	0	0	0		1991 S
17	115	0	0	0	13	E		CALCARIA	BPI	0	0	0		1991 S
17	116	0	0	0	13	E		CALCARIA	BN1G	0	0	0		1991 S
17	117	0	0	0	13	E		ESQUIST	BN2G	0	0	0	DESTRAL	1991 S
17	118	0	0	0	13	W		SILEX	BPF	0	0	0	PATINAT	1991 S
17	119	0	0	0	6	E		GRANIT	BNA	0	0	0		1991 S
17	120	0	0	0	7	E		QUARS	BNA	0	0	0		1991 S
17	121	0	0	0	10	E		CONGLOME	BNA	0	0	0	FRAG N.G.	1991 S
17	122	0	0	0	10	E		SORRENCA	BNA	0	0	0	FRAG	1991 S
17	123	0	0	0	10	E		CALCARIA	BNA	0	0	0	FRAC	1991 S
17	124	0	0	0	10	E		RMI	BNA	0	0	0		1991 S
17	125	0	0	0	10	E		SORRENCA	BNE	0	0	0	FRAG MOLI	1991 S
17	126	0	0	0	10	E		CONGLOME	BNA	0	0	0	N.G.	1991 S
17	127	0	0	0	10	W		RMI	BNA	0	0	0	FRAG	1991 S
17	128	0	0	0	10	W		RMI	BNA	0	0	0		1991 S
17	129	0	0	0	10	W		RMI	BNA	0	0	0	FRAG	1991 S
17	130	0	0	0	10	W		SORRENCA	BNA	0	0	0	FRAG	1991 S
17	131	0	0	0	10	W		QUARS	BNA	0	0	0	FRAG	1991 S
17	132	0	0	0	10	W		CALCARIA	BNA	0	0	0	N.G.	1991 S
17	133	0	0	0	11	E		RMI	BNA	0	0	0		1991 S
17	134	0	0	0	11	E		QUARS	BNA	0	0	0		1991 S
17	135	0	0	0	11	E		SORRENCA	BNA	0	0	0	FRAC	1991 S
17	136	0	0	0	11	E		RMI	BNA	0	0	0	FRAG N.G.	1991 S
17	137	0	0	0	11	E		SORRENCA	BNA	0	0	0	N.G.	1991 S
17	138	0	0	0	11	E		CONGLOME	BNA	0	0	0	FRAG N.G.	1991 S
17	139	0	0	0	11	E		CALCARIA	BNA	0	0	0	N.G.	1991 S
17	140	0	0	0	11	E		RMI	BNA	0	0	0		1991 S
17	141	0	0	0	11	W		RMI	BNA	0	0	0		1991 S
17	142	0	0	0	11	W		QUARS	BNA	0	0	0	N.G.	1991 S
17	143	0	0	0	11	W		CONGLOME	BNA	0	0	0	FRAG N.G.	1991 S
17	144	0	0	0	11	W		SORRENCA	BNA	0	0	0		1991 S
17	145	0	0	0	11	W		CONGLOME	BNA	0	0	0	FRAG	1991 S
17	146	0	0	0	11	W		RMI	BNA	0	0	0	FRAC REM 149	1991 S
17	147	0	0	0	11	W		RMI	BNA	0	0	0	N.G.	1991 S
17	148	0	0	0	11	W		SORRENCA	BNA	0	0	0	N.G.	1991 S
17	149	0	0	0	11	W		RMI	BNA	0	0	0	FRAC REM 146	1991 S
17	150	0	0	0	11	W		CONGLOME	BNA	0	0	0	FRAG	1991 S
17	151	0	0	0	11	W		RMI	BNA	0	0	0	FRAC	1991 S
17	152	0	0	0	11	W		CONGLOME	BNA	0	0	0	FRAG	1991 S
17	153	0	0	0	11	W		CONGLOME	BNA	0	0	0	FRAG N.G.	1991 S
17	154	0	0	0	11	W		CONGLOME	BNA	0	0	0	FRAG N.G.	1991 S
17	155	0	0	0	11	W		RMI	BNA	0	0	0	FRAG N.G.	1991 S
17	156	0	0	0	11	W		RMI	BNA	0	0	0	FRAG	1991 S
17	157	0	0	0	11	W		SORRENCA	BNA	0	0	0	FRAC	1991 S
17	158	0	0	0	11	W		GRANIT	BNA	0	0	0	FRAG	1991 S
17	159	0	0	0	11	W		RMI	BNA	0	0	0	FRAC N.G.	1991 S
17	160	0	0	0	11	W		RMI	BNA	0	0	0	FRAG	1991 S
17	161	0	0	0	11	W		RMI	BNA	0	0	0	FRAG	1991 S
17	162	0	0	0	11	W		RMI	BNA	0	0	0	FRAG	1991 S
17	163	0	0	0	11	W		CALCARIA	BNA	0	0	0	FRAG N.G.	1991 S
17	164	0	0	0	11	W		CONGLOME	BNA	0	0	0	FRAG N.G.	1991 S

BOBILA MADURELL  
MAS DURAN  
campanya 1991

E.E. NUM.	X	Y	Zsup	Zinf/	ORIENT	PENDENT	MATERIA	OBJECTE	LONG	AMPL	ESPE	ALTERACIONS	P D
												OBSERVACIONS	ANY U I
				Talla	SECTOR								N B
													T U
17	165	0	0	0	11	W	CONGLOME BNA		0	0	0	N.G.	1991 S
17	166	0	0	0	11	W	CONGLOME BNA		0	0	0	N.G.	1991 S
17	167	0	0	0	11	W	RMI BNA		0	0	0	N.G.	1991 S
17	168	0	0	0	12	E	CONGLOME BNA		0	0	0	FRAG	1991 S
17	169	0	0	0	12	E	SORRENCA BNA		0	0	0	N.G.	1991 S
17	170	0	0	0	12	E	SORRENCA BNA		0	0	0	FRAG N.G.	1991 S
17	171	0	0	0	12	E	CONGLOME BNA		0	0	0		1991 S
17	172	0	0	0	12	E	RMI BNA		0	0	0		1991 S
17	173	0	0	0	12	E	CONGLOME BNA		0	0	0	FRAG	1991 S
17	174	0	0	0	12	E	RMI BNA		0	0	0		1991 S
17	175	0	0	0	12	E	RMI BNA		0	0	0	FRAG	1991 S
17	176	0	0	0	12	E	SILEX BNA		0	0	0	FRAC	1991 S
17	177	0	0	0	12	E	RMI BNA		0	0	0	FRAG N.G.	1991 S
17	178	0	0	0	12	E	CALCARIA BNA		0	0	0	N.G.	1991 S
17	179	0	0	0	12	E	CALCARIA BNA		0	0	0	FRAG N.G.	1991 S
17	180	0	0	0	12	E	RMI BNA		0	0	0		1991 S
17	181	0	0	0	12	E	SORRENCA BNA		0	0	0	FRAC N.G.	1991 S
17	182	0	0	0	12	E	CALCARIA BNA		0	0	0	N.G.	1991 S
17	183	0	0	0	12	E	RMI BNA		0	0	0		1991 S
17	184	0	0	0	12	E	CONGLOME BNA		0	0	0	FRAG N.G.	1991 S
17	185	0	0	0	12	E	RMI BNA		0	0	0	N.G.	1991 S
17	186	0	0	0	12	E	RMI BNA		0	0	0	N.G.	1991 S
17	187	0	0	0	12	E	CALCARIA BNA		0	0	0	N.G.	1991 S
17	188	0	0	0	12	E	RMI BNE		0	0	0	MOLI	1991 S
17	189	0	0	0	12	W	CONGLOME BNA		0	0	0	N.G.	1991 S
17	190	0	0	0	12	W	RMI BNA		0	0	0		1991 S
17	191	0	0	0	12	W	CALCARIA BNA		0	0	0	FRAC	1991 S
17	192	0	0	0	12	W	SILEX BNA		0	0	0	FRAC	1991 S
17	193	0	0	0	12	W	RMI BNA		0	0	0		1991 S
17	194	0	0	0	12	W	RMI BNA		0	0	0	FRAG	1991 S
17	195	0	0	0	12	W	SORRENCA BNA		0	0	0	FRAG	1991 S
17	196	0	0	0	12	W	RMI BNA		0	0	0	FRAG	1991 S
17	197	0	0	0	12	W	SORRENCA BNA		0	0	0	FRAG	1991 S
17	198	0	0	0	12	W	SORRENCA BNA		0	0	0	FRAG N.G.	1991 S
17	199	0	0	0	12	W	RMI BNA		0	0	0	FRAG N.G.	1991 S
17	200	0	0	0	12	W	RMI BNA		0	0	0	FRAG N.G.	1991 S
17	201	0	0	0	12	W	CONGLOME BNA		0	0	0	FRAG N.G.	1991 S
17	202	0	0	0	12	W	SORRENCA BNA		0	0	0		1991 S
17	203	0	0	0	12	W	RMI BNA		0	0	0		1991 S
17	204	0	0	0	12	W	RMI BNA		0	0	0	FRAG N.G.	1991 S
17	205	0	0	0	12	W	RMI BNE		0	0	0	PERCUSSOR?	1991 S
17	206	0	0	0	12	W	RMI BNA		0	0	0	FRAG N.G.	1991 S
17	207	0	0	0	12	W	ESQUIST BNA		0	0	0	FRAG	1991 S
17	208	0	0	0	12	W	CALCARIA BNA		0	0	0	N.G.	1991 S
17	209	0	0	0	12	W	RMI BNA		0	0	0	FRAG	1991 S
17	210	0	0	0	12	W	SORRENCA BNA		0	0	0	FRAG N.G.	1991 S
17	211	0	0	0	12	W	ESQUIST BNA		0	0	0	FRAG	1991 S
17	212	0	0	0	12	W	CONGLOME BNA		0	0	0	FRAG N.G.	1991 S
17	213	0	0	0	13	E	RMI BNA		0	0	0	FRAC	1991 S
17	214	0	0	0	13	E	RMI BNA		0	0	0	FRAG	1991 S
17	215	0	0	0	13	E	RMI BNA		0	0	0	FRAG	1991 S

BOBILA MADURELL  
MAS DURAN  
campanya 1991

E.E. NUM.	X	Y	Zsup	Zinf/ Talla	ORIENT	PENDENT SECTOR	MATERIA	OBJECTE	LONG	AMPL	ESPE	ALTERACIONS	P D	
												OBSERVACIONS		ANY
17	216	0	0	0	13	E	RMI	BNA	0	0	0	FRAC	1991	S
17	217	0	0	0	13	E	RMI	BNA	0	0	0	FRAG	1991	S
17	218	0	0	0	13	E	RMI	BNA	0	0	0	FRAG	1991	S
17	219	0	0	0	13	E	CONGLOME	BNA	0	0	0	FRAG N.G.	1991	S
17	220	0	0	0	13	E	RMI	BNA	0	0	0	FRAG	1991	S
17	221	0	0	0	13	E	RMI	BNA	0	0	0	N.G.	1991	S
17	222	0	0	0	13	E	RMI	BNA	0	0	0	N.G.	1991	S
17	223	0	0	0	13	E	CONGLOME	BNA	0	0	0	FRAG N.G.	1991	S
17	224	0	0	0	13	E	QUARS	BNA	0	0	0		1991	S
17	225	0	0	0	13	E	SORRENCA	BNA	0	0	0	FRAG N.G.	1991	S
17	226	0	0	0	13	E	RMI	BNA	0	0	0	FRAG	1991	S
17	227	0	0	0	13	E	SORRENCA	BNA	0	0	0	FRAG	1991	S
17	228	0	0	0	13	E	RMI	BNA	0	0	0		1991	S
17	229	0	0	0	13	E	SORRENCA	BNA	0	0	0		1991	S
17	230	0	0	0	13	E	SORRENCA	BNA	0	0	0	FRAG	1991	S
17	231	0	0	0	13	E	RMI	BNA	0	0	0	FRAG N.G.	1991	S
17	232	0	0	0	13	E	SORRENCA	BNA	0	0	0	FRAG N.G.	1991	S
17	233	0	0	0	13	E	RMI	BNA	0	0	0	N.G.	1991	S
17	234	0	0	0	13	E	CALCARIA	BNA	0	0	0	N.G.	1991	S
17	235	0	0	0	13	E	CALCARIA	BNA	0	0	0		1991	S
17	236	0	0	0	13	W	RMI	BNA	0	0	0		1991	S
17	237	0	0	0	13	W	RMI	BNA	0	0	0	FRAG N.G.	1991	S
17	238	0	0	0	13	W	RMI	BNA	0	0	0	FRAG N.G.	1991	S
17	239	0	0	0	13	W	RMI	BNA	0	0	0	FRAG N.G.	1991	S
17	240	0	0	0	13	W	RMI	BNA	0	0	0	FRAG	1991	S
17	241	0	0	0	13	W	RMI	BNA	0	0	0		1991	S
17	242	0	0	0	13	W	RMI	BNA	0	0	0		1991	S
17	243	0	0	0	13	W	RMI	BNA	0	0	0	FRAG	1991	S
17	244	0	0	0	13	W	SORRENCA	BNA	0	0	0	FRAG	1991	S
17	245	0	0	0	13	W	SORRENCA	BNA	0	0	0	FRAG	1991	S
17	246	0	0	0	13	W	RMI	BNA	0	0	0	FRAG	1991	S
17	247	0	0	0	13	W	RMI	BNA	0	0	0	N.G.	1991	S
17	248	0	0	0	13	W	RMI	BNA	0	0	0	FRAG N.G.	1991	S
17	249	0	0	0	13	W	RMI	BNA	0	0	0	N.G.	1991	S
17	250	0	0	0	13	W	CONGLOME	BNA	0	0	0	FRAG N.G.	1991	S
17	251	0	0	0	13	W	SORRENCA	BNA	0	0	0	FRAG	1991	S
17	252	0	0	0	13	W	RMI	BNA	0	0	0	FRAG	1991	S
17	253	0	0	0	13	W	RMI	BNA	0	0	0	FRAG	1991	S
17	254	0	0	0	13	W	RMI	BNA	0	0	0		1991	S
17	255	0	0	0	13	W	CONGLOME	BNA	0	0	0	FRAG	1991	S
17	256	0	0	0	13	W	CONGLOME	BNA	0	0	0		1991	S
17	257	0	0	0	13	E	OS	INDET	0	0	0	CREMAT	1991	S
17	258	0	0	0	13	E	OS	INDET	0	0	0	CREMAT	1991	S
17	259	0	0	0	13	W	OS	INDET	0	0	0	CREMAT	1991	S
17	260	0	0	0	13	W	OS	INDET	0	0	0	CREMAT	1991	S
17	261	0	0	0	10	E	CONGLOME	BNA	0	0	0	N.G.	1991	S
17	262	0	0	0	12	W	CALCARIA	BNA	0	0	0	FRAG N.G.	1991	S
17	263	0	0	0	12	W	CALCARIA	BNA	0	0	0	N.G.	1991	S
17	264	0	0	0	12	W	CONGLOME	BNA	0	0	0	N.G.	1991	S
17	265	0	0	0	12	W	CALCARIA	BNA	0	0	0	N.G.	1991	S
18	1	0	0	0	10	E	CERAMICA	INFORME	0	0	0		1991	S

BOBILA MADURELL  
MAS DURAN  
campanya 1991

E.E. NUM.	X	Y	Zsup	Zinf/	ORIENT	PENDENT	MATERIA	OBJECTE	LONG	AMPL	ESPE	ALTERACIONS	P D	
												OBSERVACIONS		ANY U I
												N B	T U	
				Talla	SECTOR									
18	2	0	0	0	10	E	CERAMICA	INFORME	0	0	0	VARIS FRAGS	1991 S	
18	3	0	0	0	10	E	CERAMICA	INFORME	0	0	0		1991 S	
18	4	0	0	0	10	E	CERAMICA	VORA	0	0	0	APLICA MUGRO	1991 S	
18	5	0	0	0	10	W	CERAMICA	INFORME	0	0	0	3 FRAGS	1991 S	
18	6	0	0	0	10	W	CERAMICA	INFORME	0	0	0		1991 S	
18	7	0	0	0	10	W	CERAMICA	INFORME	0	0	0		1991 S	
18	8	0	0	0	10	W	CERAMICA	INFORME	0	0	0	2 FRAGS	1991 S	
18	9	0	0	0	10	W	CERAMICA	INFORME	0	0	0		1991 S	
18	10	0	0	0	10	W	CERAMICA	INFORME	0	0	0		1991 S	
18	11	0	0	0	10	W	CERAMICA	CARENA	0	0	0		1991 S	
18	12	0	0	0	10	W	CERAMICA	INFORME	0	0	0		1991 S	
18	13	0	0	0	10	W	CERAMICA	INFORME	0	0	0	PENTINADA	1991 S	
18	14	0	0	0	11	E	CERAMICA	INFORME	0	0	0	VARIS FRAGS	1991 S	
18	15	0	0	0	11	E	CERAMICA	INFORME	0	0	0	VARIS FRAGS	1991 S	
18	16	0	0	0	11	E	CERAMICA	INFORME	0	0	0		1991 S	
18	17	0	0	0	11	E	CERAMICA	INFORME	0	0	0		1991 S	
18	18	0	0	0	11	E	CERAMICA	INFORME	0	0	0		1991 S	
18	19	0	0	0	11	E	CERAMICA	INFORME	0	0	0	VARIS FRAGS	1991 S	
18	20	0	0	0	11	W	CERAMICA	INFORME	0	0	0		1991 S	
18	21	0	0	0	11	W	CERAMICA	INFORME	0	0	0		1991 S	
18	22	0	0	0	11	W	CERAMICA	INFORME	0	0	0		1991 S	
18	23	0	0	0	11	W	CERAMICA	INFORME	0	0	0	PENTINADA	1991 S	
18	24	0	0	0	11	W	CERAMICA	VORA	0	0	0	DEC. INTERN	1991 S	
18	25	0	0	0	11	W	CERAMICA	INFORME	0	0	0		1991 S	
18	26	0	0	0	12	E	CERAMICA	INFORME	0	0	0		1991 S	
18	27	0	0	0	12	E	CERAMICA	INFORME	0	0	0	VARIS FRAGS	1991 S	
18	28	0	0	0	12	E	CERAMICA	INFORME	0	0	0	VARIS FRAGS	1991 S	
18	29	0	0	0	12	E	CERAMICA	INFORME	0	0	0		1991 S	
18	30	0	0	0	12	E	CERAMICA	INFORME	0	0	0	VARIS FRAGS	1991 S	
18	31	0	0	0	12	E	CERAMICA	INFORME	0	0	0		1991 S	
18	32	0	0	0	12	E	CERAMICA	INFORME	0	0	0	VARIS FRAGS	1991 S	
18	33	0	0	0	12	E	CERAMICA	INFORME	0	0	0	VARIS FRAGS	1991 S	
18	34	0	0	0	12	E	CERAMICA	INFORME	0	0	0		1991 S	
18	35	0	0	0	12	E	CERAMICA	INFORME	0	0	0		1991 S	
18	36	0	0	0	12	W	CERAMICA	INFORME	0	0	0		1991 S	
18	37	0	0	0	12	W	CERAMICA	APLICA	0	0	0	CORDO	1991 S	
18	38	0	0	0	12	W	CERAMICA	INFORME	0	0	0		1991 S	
18	39	0	0	0	12	W	CERAMICA	INFORME	0	0	0	2 FRAGS	1991 S	
18	40	0	0	0	12	W	CERAMICA	INFORME	0	0	0		1991 S	
18	41	0	0	0	12	W	CERAMICA	INFORME	0	0	0		1991 S	
18	42	0	0	0	12	W	CERAMICA	INFORME	0	0	0		1991 S	
18	43	0	0	0	12	W	CERAMICA	INFORME	0	0	0		1991 S	
18	44	0	0	0	12	W	CERAMICA	INFORME	0	0	0		1991 S	
18	45	0	0	0	13	E	CERAMICA	INFORME	0	0	0	VARIS FRAGS	1991 S	
18	46	0	0	0	13	E	CERAMICA	INFORME	0	0	0	VARIS FRAGS	1991 S	
18	47	0	0	0	13	W	CERAMICA	INFORME	0	0	0		1991 S	
18	48	0	0	0	13	W	CERAMICA	INFORME	0	0	0		1991 S	
18	49	0	0	0	13	W	CERAMICA	INFORME	0	0	0		1991 S	
18	50	0	0	0	13	W	CERAMICA	INFORME	0	0	0	VARIS FRAGS	1991 S	
18	51	0	0	0	13	W	CERAMICA	INFORME	0	0	0		1991 S	
18	52	0	0	0	13	W	CERAMICA	INFORME	0	0	0		1991 S	



BOBILA MADURELL  
MAS DURAN  
campanya 1991

E.E. NUM.	X	Y	Zsup	Zinf/	ORIENT	PENDENT	MATERIA	OBJECTE	LONG	AMPL	ESPE	ALTERACIONS	P D
												Talla	
18	53	0	0	0	13	W	CERAMICA	INFORME	0	0	0	VARIS FRAGS	1991 S
18	54	0	0	0	13	W	CERAMICA	VORA	0	0	0	2 FRAGS	1991 S
18	55	0	0	0	13	W	CERAMICA	INFORME	0	0	0	3 FRAGS	1991 S
18	56	0	0	0	13	W	CERAMICA	INFORME	0	0	0	VARIS FRAGS	1991 S
18	57	0	0	0	13	W	CERAMICA	INFORME	0	0	0	VARIS FRAGS	1991 S
18	58	0	0	0	13	W	CERAMICA	VORA	0	0	0		1991 S
18	59	0	0	0	13	W	CERAMICA	PANXA	0	0	0	VARIS FRAGS	1991 S
18	60	0	0	0	13	W	CERAMICA	VORA	0	0	0		1991 S
18	61	0	0	0	13	W	CERAMICA	APLICA	0	0	0	MAMELO	1991 S
18	62	0	0	0	13	W	CERAMICA	INFORME	0	0	0		1991 S
18	63	0	0	0	13	W	CERAMICA	INFORME	0	0	0		1991 S
18	64	0	0	0	10	W	SILEX	BP	0	0	0		1991 S
18	65	0	0	0	10	W	QUARSITA	BP	0	0	0		1991 S
18	66	0	0	0	11	E	SILEX	BN1G	0	0	0		1991 S
18	67	0	0	0	11	W	SILEX	BN1G	0	0	0		1991 S
18	68	0	0	0	12	W	SILEX	BPF	0	0	0		1991 S
18	69	0	0	0	10	E	SORRENCA	BNE	0	0	0	MOLI	1991 S
18	70	0	0	0	10	E	SORRENCA	BNA	0	0	0	N.G.	1991 S
18	71	0	0	0	10	W	RMI	BNA	0	0	0	FRAG N.G.	1991 S
18	72	0	0	0	10	W	CONGLOME	BNA	0	0	0	FRAG N.G.	1991 S
18	73	0	0	0	10	W	RMI	BNA	0	0	0	FRAG	1991 S
18	74	0	0	0	10	W	QUARSITA	BNA	0	0	0		1991 S
18	75	0	0	0	10	W	RMI	BNA	0	0	0	FRAG	1991 S
18	76	0	0	0	10	W	RMI	BNA	0	0	0	FRAG	1991 S
18	77	0	0	0	10	W	GRANIT	BNA	0	0	0	FRAG	1991 S
18	78	0	0	0	10	W	CONGLOME	BNE	0	0	0	2 FRAGS MOLI	1991 S
18	79	0	0	0	10	W	SORRENCA	BNE	0	0	0	MOLI	1991 S
18	80	0	0	0	10	W	CALCARIA	BNA	0	0	0	N.G.	1991 S
18	81	0	0	0	11	E	RMI	BNA	0	0	0	FRAG N.G.	1991 S
18	82	0	0	0	11	E	CONGLOME	BNA	0	0	0	N.G.	1991 S
18	83	0	0	0	11	E	RMI	BNA	0	0	0	FRAG	1991 S
18	84	0	0	0	11	E	RMI	BNA	0	0	0	FRAG	1991 S
18	85	0	0	0	11	E	RMI	BNA	0	0	0	FRAG	1991 S
18	86	0	0	0	11	W	CALCARIA	BNA	0	0	0	VARIS FRAGS N.G.	1991 S
18	87	0	0	0	11	W	RMI	BNA	0	0	0	FRAG	1991 S
18	88	0	0	0	11	W	RMI	BNA	0	0	0	FRAG	1991 S
18	89	0	0	0	11	W	GRANIT	BNA	0	0	0	FRAG N.G.	1991 S
18	90	0	0	0	12	E	QUARS	BNA	0	0	0	N.G.	1991 S
18	91	0	0	0	12	E	RMI	BNA	0	0	0	N.G.	1991 S
18	92	0	0	0	12	E	RMI	BNA	0	0	0	N.G.	1991 S
18	93	0	0	0	12	E	CONGLOME	BNE	0	0	0	FRAG MOLI	1991 S
18	94	0	0	0	12	E	RMI	BNA	0	0	0	FRAG N.G.	1991 S
18	95	0	0	0	12	E	RMI	BNA	0	0	0	FRAG	1991 S
18	96	0	0	0	12	E	RMI	BNA	0	0	0	FRAG	1991 S
18	97	0	0	0	12	E	RMI	BNA	0	0	0	FRAG N.G.	1991 S
18	98	0	0	0	12	W	SORRENCA	BNE	0	0	0	MOLI	1991 S
18	99	0	0	0	12	W	RMI	BNA	0	0	0	FRAG	1991 S
18	100	0	0	0	12	W	RMI	BNA	0	0	0	FRAG	1991 S
18	101	0	0	0	12	W	RMI	BNA	0	0	0	N.G.	1991 S
18	102	0	0	0	12	W	CONGLOME	BNA	0	0	0	N.G.	1991 S
18	103	0	0	0	12	W	GRANIT	BNA	0	0	0	N.G.	1991 S

BOBILA MADURELL  
MAS DURAN  
campanya 1991

E.E. NUM.	X	Y	Zsup	Zinf/ Talla	ORIENT	PENDENT SECTOR	MATERIA	OBJECTE	LONG	AMPL	ESPE	ALTERACIONS OBSERVACIONS	P D ANY U I N B T U
18	104	0	0	0	12	E	CALCARIA	BNA	0	0	0	FRAG	1991 S
18	105	0	0	0	12	E	GRANIT	BNA	0	0	0	FRAG N.G.	1991 S
18	106	0	0	0	12	W	CONGLOME	BNA	0	0	0	N.G.	1991 S
18	107	0	0	0	11	E	GRANIT	BNA	0	0	0	FRAG	1991 S
18	108	0	0	0	11	E	GRANIT	BNA	0	0	0	FRAG N.G.	1991 S
18	109	0	0	0	11	E	RMI	BNA	0	0	0	2 FRAGS	1991 S
18	110	0	0	0	11	E	RMI	BNA	0	0	0	FRAG	1991 S
18	111	0	0	0	11	E	QUARS	BNA	0	0	0	FRAG	1991 S
18	112	0	0	0	11	E	RMI	BNA	0	0	0	FRAG	1991 S
18	113	0	0	0	11	E	QUARSITA	BNA	0	0	0		1991 S
18	114	0	0	0	11	W	SORRENCA	BNA	0	0	0		1991 S
18	115	0	0	0	11	W	RMI	BNA	0	0	0	FRAG	1991 S
18	116	0	0	0	11	W	RMI	BNA	0	0	0		1991 S
18	117	0	0	0	11	W	RMI	BNA	0	0	0		1991 S
18	118	0	0	0	11	W	RMI	BNA	0	0	0	FRAG N.G.	1991 S
18	119	0	0	0	11	W	RMI	BNA	0	0	0	FRAG	1991 S
18	120	0	0	0	13	E	RMI	BNA	0	0	0	FRAG N.G.	1991 S
18	121	0	0	0	13	E	RMI	BNA	0	0	0		1991 S
18	122	0	0	0	13	W	QUARS	BNA	0	0	0	N.G.	1991 S
18	123	0	0	0	13	W	CONGLOME	BNA	0	0	0		1991 S
18	124	0	0	0	13	W	CONGLOME	BNE	0	0	0	MOLI	1991 S
18	125	0	0	0	10	W	OS	INDET	0	0	0	2 FRAGS CREMAT	1991 S
18	126	0	0	0	10	W	OS	INDET	0	0	0	2 FRAGS	1991 S
18	127	0	0	0	10	W	OS	INDET	0	0	0	CREMAT	1991 S
18	128	0	0	0	11	E	OS	DET	0	0	0	CREMAT	1991 S
18	129	0	0	0	11	W	OS	INDET	0	0	0	CREMAT	1991 S
18	130	0	0	0	11	W	OS	INDET	0	0	0	CREMAT	1991 S
18	131	0	0	0	12	E	OS	INDET	0	0	0	VARIS FRAGS	1991 S
18	132	0	0	0	12	E	OS	INDET	0	0	0		1991 S
18	133	0	0	0	12	W	OS	DET	0	0	0	FE BOTA	1991 S
18	134	0	0	0	13	E	OS	INDET	0	0	0		1991 S
18	135	0	0	0	13	E	OS	INDET	0	0	0	V. FRAGS CREMAT	1991 S
18	136	0	0	0	13	W	OS	INDET	0	0	0	CREMAT	1991 S
18	137	0	0	0	13	W	OS	INDET	0	0	0	2 FRAGS	1991 S
19	1	0	0	0	9	E	CERAMICA	INFORME	0	0	0	2 FRAGS	1991 S
19	2	0	0	0	9	E	CERAMICA	INFORME	0	0	0	VARIS FRAGS	1991 S
19	3	0	0	0	9	E	CERAMICA	INFORME	0	0	0	VARIS FRAGS	1991 S
19	4	0	0	0	9	E	CERAMICA	INFORME	0	0	0	VARIS FRAGS	1991 S
19	5	0	0	0	9	E	CERAMICA	INFORME	0	0	0	2 FRAGS	1991 S
19	6	0	0	0	9	E	CERAMICA	INFORME	0	0	0	3 FRAGS	1991 S
19	7	0	0	0	9	E	CERAMICA	INFORME	0	0	0	VARIS FRAGS	1991 S
19	8	0	0	0	9	E	CERAMICA	INFORME	0	0	0	2 FRAGS	1991 S
19	9	0	0	0	9	E	CERAMICA	INFORME	0	0	0	VARIS FRAGS	1991 S
19	10	0	0	0	9	E	CERAMICA	VORA	0	0	0	APLICA MUGRO	1991 S
19	11	0	0	0	9	E	CERAMICA	INFORME	0	0	0	3 FRAGS	1991 S
19	12	0	0	0	9	E	CERAMICA	VORA	0	0	0	APLICA MUGRO	1991 S
19	13	0	0	0	10	E	CERAMICA	INFORME	0	0	0		1991 S
19	14	0	0	0	10	E	CERAMICA	CARENA	0	0	0		1991 S
19	15	0	0	0	10	E	CERAMICA	APLICA	0	0	0	MAMELO	1991 S
19	16	0	0	0	10	E	CERAMICA	NANSA	0	0	0	2 FRAGS	1991 S
19	17	0	0	0	10	E	CERAMICA	INFORME	0	0	0	VARIS FRAGS	1991 S

BOBILA MADURELL  
MAS DURAN  
campanya 1991

E.E. NUM.	X	Y	Zsup	Zinf/ Talla	ORIENT	PENDENT SECTOR	MATERIA	OBJECTE	LONG	AMPL	ESPE	ALTERACIONS	P D
												OBSERVACIONS	ANY U I N B T U
19	18	0	0	0	10	E	CERAMICA	INFORME	0	0	0	VARIS FRAGS	1991 S
19	19	0	0	0	10	E	CERAMICA	INFORME	0	0	0		1991 S
19	20	0	0	0	10	W	CERAMICA	VORA	0	0	0		1991 S
19	21	0	0	0	10	W	CERAMICA	INFORME	0	0	0		1991 S
19	22	0	0	0	10	W	CERAMICA	INFORME	0	0	0		1991 S
19	23	0	0	0	10	W	CERAMICA	INFORME	0	0	0		1991 S
19	24	0	0	0	10	W	CERAMICA	VORA	0	0	0		1991 S
19	25	0	0	0	10	W	CERAMICA	INFORME	0	0	0	3 FRAGS	1991 S
19	26	0	0	0	10	W	CERAMICA	INFORME	0	0	0	3 FRAGS	1991 S
19	27	0	0	0	10	W	CERAMICA	INFORME	0	0	0	V.FRAGS REM 31	1991 S
19	28	0	0	0	11	E	CERAMICA	VORA	0	0	0		1991 S
19	29	0	0	0	11	E	CERAMICA	INFORME	0	0	0		1991 S
19	30	0	0	0	11	W	CERAMICA	INFORME	0	0	0	REM 38	1991 S
19	31	0	0	0	11	W	CERAMICA	INFORME	0	0	0	REM 29	1991 S
19	32	0	0	0	11	W	CERAMICA	INFORME	0	0	0		1991 S
19	33	0	0	0	11	W	CERAMICA	INFORME	0	0	0		1991 S
19	34	0	0	0	11	W	CERAMICA	INFORME	0	0	0	4 FRAGS	1991 S
19	35	0	0	0	11	W	CERAMICA	CARENA	0	0	0		1991 S
19	36	0	0	0	11	W	CERAMICA	INFORME	0	0	0		1991 S
19	37	0	0	0	11	W	CERAMICA	INFORME	0	0	0		1991 S
19	38	0	0	0	11	W	CERAMICA	INFORME	0	0	0	REM 30	1991 S
19	39	0	0	0	11	W	CERAMICA	INFORME	0	0	0	VARIS FRAGS	1991 S
19	40	0	0	0	11	W	CERAMICA	NANSA	0	0	0		1991 S
19	41	0	0	0	12	E	CERAMICA	INFORME	0	0	0	VARIS FRAGS	1991 S
19	42	0	0	0	12	E	CERAMICA	CARENA	0	0	0		1991 S
19	43	0	0	0	12	E	CERAMICA	INFORME	0	0	0		1991 S
19	44	0	0	0	12	W	CERAMICA	INFORME	0	0	0		1991 S
19	45	0	0	0	12	W	CERAMICA	INFORME	0	0	0		1991 S
19	46	0	0	0	12	W	CERAMICA	INFORME	0	0	0		1991 S
19	47	0	0	0	12	W	CERAMICA	INFORME	0	0	0		1991 S
19	48	0	0	0	12	W	CERAMICA	INFORME	0	0	0		1991 S
19	49	0	0	0	12	W	CERAMICA	VORA	0	0	0		1991 S
19	50	0	0	0	12	W	CERAMICA	INFORME	0	0	0		1991 S
19	51	0	0	0	13	W	CERAMICA	APLICA	0	0	0	LLENGETA	1991 S
19	52	0	0	0	13	W	CERAMICA	APLICA	0	0	0	LLENGETA	1991 S
19	53	0	0	0	13	W	CERAMICA	VORA	0	0	0	VARIS FRAGS	1991 S
19	54	0	0	0	13	W	CERAMICA	INFORME	0	0	0	2 FRAGS	1991 S
19	55	0	0	0	13	W	CERAMICA	VORA	0	0	0		1991 S
19	56	0	0	0	14	E	CERAMICA	VORA	0	0	0		1991 S
19	57	0	0	0	14	E	CERAMICA	INFORME	0	0	0	3 FRAGS	1991 S
19	58	0	0	0	14	E	CERAMICA	INFORME	0	0	0		1991 S
19	59	0	0	0	14	E	CERAMICA	INFORME	0	0	0		1991 S
19	60	0	0	0	14	W	CERAMICA	VORA	0	0	0		1991 S
19	61	0	0	0	14	W	CERAMICA	INFORME	0	0	0		1991 S
19	62	0	0	0	14	W	CERAMICA	CARENA	0	0	0		1991 S
19	63	0	0	0	14	W	CERAMICA	CARENA	0	0	0	VARIS FRAGS	1991 S
19	64	0	0	0	14	W	CERAMICA	VORA	0	0	0	INCISIO VORA	1991 S
19	65	0	0	0	14	W	CERAMICA	VAS	0	0	0		1991 S
19	66	0	0	0	14	W	CERAMICA	INFORME	0	0	0	VARIS FRAGS	1991 S
19	67	0	0	0	14	W	CERAMICA	INFORME	0	0	0	VARIS FRAGS	1991 S
19	68	0	0	0	14	W	CERAMICA	INFORME	0	0	0	VARIS FRAGS	1991 S

BIBILA MADURELL  
985 DURAN  
COMPANY 1991

LINE	QUANTITY	UNIT	DESCRIPTION	DATE	PRICE	TOTAL	REMARKS
19	80	0	CERAMICA INFORNE	0	0	0	1991 S
19	81	0	CERAMICA INFORNE	0	0	0	1991 S
19	82	0	CERAMICA INFORNE	0	0	0	1991 S
19	83	0	CERAMICA INFORNE	0	0	0	1991 S
19	84	0	CERAMICA INFORNE	0	0	0	1991 S
19	85	0	CERAMICA INFORNE	0	0	0	1991 S
19	86	0	CERAMICA INFORNE	0	0	0	1991 S
19	87	0	CERAMICA INFORNE	0	0	0	1991 S
19	88	0	CERAMICA INFORNE	0	0	0	1991 S
19	89	0	CERAMICA CARENA	0	0	0	1991 S
19	90	0	CERAMICA APLICA	0	0	0	1991 S
19	91	0	CERAMICA INFORNE	0	0	0	1991 S
19	92	0	CERAMICA INFORNE	0	0	0	1991 S
19	93	0	CERAMICA VORA	0	0	0	1991 S
19	94	0	CERAMICA VORA	0	0	0	1991 S
19	95	0	CERAMICA VORA	0	0	0	1991 S
19	96	0	CERAMICA VORA	0	0	0	1991 S
19	97	0	CERAMICA INFORNE	0	0	0	1991 S
19	98	0	CERAMICA INFORNE	0	0	0	1991 S
19	99	0	CERAMICA INFORNE	0	0	0	1991 S
19	100	0	CERAMICA INFORNE	0	0	0	1991 S
19	101	0	CERAMICA VORA	0	0	0	1991 S
19	102	0	CERAMICA VORA	0	0	0	1991 S
19	103	0	CERAMICA VORA	0	0	0	1991 S
19	104	0	CERAMICA VORA	0	0	0	1991 S
19	105	0	CERAMICA VORA	0	0	0	1991 S
19	106	0	CERAMICA VORA	0	0	0	1991 S
19	107	0	CERAMICA VORA	0	0	0	1991 S
19	108	0	CERAMICA VORA	0	0	0	1991 S
19	109	0	CERAMICA VORA	0	0	0	1991 S
19	110	0	CERAMICA VORA	0	0	0	1991 S
19	111	0	CERAMICA ZINIMA	0	0	0	1991 S
19	112	0	CERAMICA VORA	0	0	0	1991 S
19	113	0	CERAMICA VORA	0	0	0	1991 S
19	114	0	CERAMICA VORA	0	0	0	1991 S
19	115	0	CERAMICA VORA	0	0	0	1991 S
19	116	0	CERAMICA VORA	0	0	0	1991 S
19	117	0	CERAMICA INFORNE	0	0	0	1991 S
19	118	0	CERAMICA INFORNE	0	0	0	1991 S

BOSILA MADURELL  
6885 BURAN  
Campanya 1991

							ALTERACIONES			# I	
III	III	III	III	III	III	III	III	III	III	III	
Talas							MAREJE			III	
19	121	I	I	I	14	III	CERAMICA INFORNE	I	I	I	1991 S
19	122	I	I	I	14	III	CERAMICA INFORNE	I	I	I	1991 S
19	123	I	I	I	14	III	CERAMICA INFORNE	I	I	I	1991 S
19	124	I	I	I	14	III	CERAMICA INFORNE	I	I	I	1991 S
19	125	I	I	I	14	III	CERAMICA INFORNE	I	I	I	1991 S
19	126	I	I	I	14	III	CERAMICA INFORNE	I	I	I	1991 S
19	127	I	I	I	14	III	CERAMICA INFORNE	I	I	I	1991 S
19	128	I	I	I	14	III	CERAMICA INFORNE	I	I	I	1991 S
19	129	I	I	I	14	III	CERAMICA INFORNE	I	I	I	1991 S
19	130	0	0	0	15	E	CERAMICA INFORNE	0	0	0	1991 S
19	131	0	0	0	15	E	CERAMICA VORA	0	0	0	1991 S
19	132	0	0	0	15	E	CERAMICA INFORNE	0	0	0	1991 S
19	133	0	0	0	15	E	CERAMICA INFORNE	0	0	0	1991 S
19	134	0	0	0	15	E	CERAMICA INFORNE	0	0	0	1991 S
19	135	0	0	0	15	E	CERAMICA INFORNE	0	0	0	1991 S
19	136	0	0	0	15	E	CERAMICA INFORNE	0	0	0	1991 S
19	137	0	0	0	15	E	CERAMICA INFORNE	0	0	0	1991 S
19	138	0	0	0	15	E	CERAMICA MANSO	0	0	0	1991 S
19	139	0	0	0	15	E	CERAMICA CARENA	0	0	0	1991 S
19	140	0	0	0	15	E	CERAMICA INFORNE	0	0	0	1991 S
19	141	0	0	0	15	E	CERAMICA INFORNE	0	0	0	1991 S
19	142	0	0	0	15	E	CERAMICA INFORNE	0	0	0	1991 S
19	143	0	0	0	15	E	CERAMICA INFORNE	0	0	0	1991 S
19	144	0	0	0	15	E	CERAMICA INFORNE	0	0	0	1991 S
19	145	0	0	0	15	E	CERAMICA VORA	0	0	0	1991 S
19	146	0	0	0	15	E	CERAMICA INFORNE	0	0	0	1991 S
19	147	0	0	0	15	E	CERAMICA INFORNE	0	0	0	1991 S
19	148	0	0	0	15	E	CERAMICA INFORNE	0	0	0	1991 S
19	149	0	0	0	15	E	CERAMICA INFORNE	0	0	0	1991 S
19	150	0	0	0	15	E	CERAMICA INFORNE	0	0	0	1991 S
19	151	0	0	0	15	E	CERAMICA INFORNE	0	0	0	1991 S
19	152	0	0	0	15	E	CERAMICA INFORNE	0	0	0	1991 S
19	153	0	0	0	15	E	CERAMICA INFORNE	0	0	0	1991 S
19	154	0	0	0	15	E	CERAMICA INFORNE	0	0	0	1991 S
19	155	0	0	0	15	E	CERAMICA INFORNE	0	0	0	1991 S
19	156	0	0	0	15	E	CERAMICA INFORNE	0	0	0	1991 S
19	157	0	0	0	15	E	CERAMICA INFORNE	0	0	0	1991 S
19	158	0	0	0	15	E	CERAMICA INFORNE	0	0	0	1991 S
19	159	0	0	0	15	E	CERAMICA INFORNE	0	0	0	1991 S

BOBILA MADURELL  
MAS DURAN  
campanya 1991

E.E. NUM.	X	Y	Zsup	Zinf/ Talla	ORIENT	PENDENT SECTOR	MATERIA	OBJECTE	LONG	AMPL	ESPE	ALTERACIONS	P D
												OBSERVACIONS	ANY U I N B T U
19	170	0	0	0	15	W	CERAMICA	INFORME	0	0	0		1991 S
19	171	0	0	0	15	W	CERAMICA	VORA	0	0	0		1991 S
19	172	0	0	0	15	W	CERAMICA	VORA	0	0	0	NANSA	1991 S
19	173	0	0	0	15	W	CERAMICA	INFORME	0	0	0		1991 S
19	174	0	0	0	15	W	CERAMICA	INFORME	0	0	0		1991 S
19	175	0	0	0	15	W	CERAMICA	INFORME	0	0	0		1991 S
19	176	0	0	0	15	W	CERAMICA	INFORME	0	0	0	2 FRAGS	1991 S
19	177	0	0	0	15	W	CERAMICA	INFORME	0	0	0	VARIS FRAGS	1991 S
19	178	0	0	0	15	W	CERAMICA	INFORME	0	0	0		1991 S
19	179	0	0	0	15	W	CERAMICA	INFORME	0	0	0		1991 S
19	180	0	0	0	15	W	CERAMICA	INFORME	0	0	0		1991 S
19	181	0	0	0	15	W	CERAMICA	INFORME	0	0	0		1991 S
19	182	0	0	0	15	W	CERAMICA	INFORME	0	0	0		1991 S
19	183	0	0	0	15	W	CERAMICA	INFORME	0	0	0		1991 S
19	184	0	0	0	15	W	CERAMICA	INFORME	0	0	0		1991 S
19	185	0	0	0	15	W	CERAMICA	VORA	0	0	0		1991 S
19	186	0	0	0	15	W	CERAMICA	INFORME	0	0	0		1991 S
19	187	0	0	0	15	W	CERAMICA	CARENA	0	0	0		1991 S
19	188	0	0	0	15	W	CERAMICA	INFORME	0	0	0		1991 S
19	189	0	0	0	15	W	CERAMICA	INFORME	0	0	0		1991 S
19	190	0	0	0	15	W	CERAMICA	CARENA	0	0	0		1991 S
19	191	0	0	0	15	W	CERAMICA	INFORME	0	0	0		1991 S
19	192	0	0	0	15	W	CERAMICA	APLICA	0	0	0	MUGRO	1991 S
19	193	0	0	0	9	E	SILEX	BN2G	0	0	0	PATINAT	1991 S
19	194	0	0	0	11	E	SILEX	BN2G	0	0	0	PATINAT LAMINA	1991 S
19	195	0	0	0	11	W	QUARSITA	BP	0	0	0		1991 S
19	196	0	0	0	11	W	SILEX	BN2G	0	0	0	LAMINA	1991 S
19	197	0	0	0	11	W	SILEX	BN2G	0	0	0		1991 S
19	198	0	0	0	11	W	SILEX	BPF	0	0	0	FRAG LAMINA	1991 S
19	199	0	0	0	12	E	SILEX	BPF	0	0	0	PATINAT	1991 S
19	200	0	0	0	14	W	SILEX	BPF	0	0	0	LAMINETA	1991 S
19	201	0	0	0	14	E	SILEX	BP	0	0	0	LAMINA	1991 S
19	202	0	0	0	14	W	SILEX	BPF	0	0	0	PATINAT	1991 S
19	203	0	0	0	14	W	QUARS	BPF	0	0	0		1991 S
19	204	0	0	0	14	W	QUARSITA	BP	0	0	0		1991 S
19	205	0	0	0	14	W	SILEX	BN2G	0	0	0	PATINAT LAMINA	1991 S
19	206	0	0	0	14	W	SILEX	BPF	0	0	0	LAMINETA	1991 S
19	207	0	0	0	14	W	SILEX	BP2G	0	0	0		1991 S
19	208	0	0	0	14	W	SILEX	BN2G	0	0	0	FRAG BN1G	1991 S
19	209	0	0	0	15	E	SILEX	BPF	0	0	0	LAMINA	1991 S
19	210	0	0	0	15	E	SILEX	BPF	0	0	0	LAMINA	1991 S
19	211	0	0	0	15	W	SILEX	BN2G	0	0	0	PATINA CONCRECI	1991 S
19	212	0	0	0	15	W	SILEX	BP2G	0	0	0		1991 S
19	213	0	0	0	15	W	SILEX	BPF	0	0	0		1991 S
19	214	0	0	0	15	W	SILEX	BP	0	0	0		1991 S
19	215	0	0	0	15	W	SILEX	BPF	0	0	0		1991 S
19	216	0	0	0	15	W	SILEX	BPF	0	0	0		1991 S
19	217	0	0	0	9	E	SORRENCA	BNA	0	0	0	FRAG	1991 S
19	218	0	0	0	9	E	CONGLOME	BNE	0	0	0		1991 S
19	219	0	0	0	10	E	QUARS	BNA	0	0	0	FRAC	1991 S
19	220	0	0	0	10	W	RMI	BNA	0	0	0	FRAG	1991 S

BOBILA MADURELL  
MAS DURAN  
campanya 1991

E.E. NUM.	X	Y	Zsup	Zinf/ Talla	ORIENT	PENDENT SECTOR	MATERIA	OBJECTE	LONG	AMPL	ESPE	ALTERACIONS	P D
												OBSERVACIONS	
19	221	0	0	0	10	W	QUARS	BNA	0	0	0	FRAC	1991 S
19	222	0	0	0	10	W	SORRENCA	BNA	0	0	0	FRAC REM 224	1991 S
19	223	0	0	0	10	W	SORRENCA	BNA	0	0	0	FRAG N.G.	1991 S
19	224	0	0	0	10	W	SORRENCA	BNA	0	0	0	FRAG REM 222	1991 S
19	225	0	0	0	10	W	ESQUIST	BNA	0	0	0	FRAG	1991 S
19	226	0	0	0	10	W	RMI	BNA	0	0	0	FRAG	1991 S
19	227	0	0	0	10	W	SORRENCA	BNA	0	0	0	FRAG N.G.	1991 S
19	228	0	0	0	10	W	RMI	BNA	0	0	0	N.G.	1991 S
19	229	0	0	0	10	W	RMI	BNA	0	0	0	FRAG N.G.	1991 S
19	230	0	0	0	11	E	CONGLOME	BNA	0	0	0	FRAG	1991 S
19	231	0	0	0	11	E	RMI	BNA	0	0	0	FRAG	1991 S
19	232	0	0	0	11	W	RMI	BNA	0	0	0	FRAG	1991 S
19	233	0	0	0	11	W	SORRENCA	BNA	0	0	0	FRAG	1991 S
19	234	0	0	0	11	W	QUARSITA	BNA	0	0	0		1991 S
19	235	0	0	0	11	W	ESQUIST	BNA	0	0	0	FRAG	1991 S
19	236	0	0	0	11	W	ESQUIST	BNA	0	0	0	FRAG	1991 S
19	237	0	0	0	11	W	SILEX	BNA	0	0	0		1991 S
19	238	0	0	0	12	E	RMI	BNA	0	0	0	FRAG	1991 S
19	239	0	0	0	12	W	RMI	BNA	0	0	0	FRAG	1991 S
19	240	0	0	0	12	W	RMI	BNA	0	0	0		1991 S
19	241	0	0	0	12	W	QUARS	BP	0	0	0		1991 S
19	242	0	0	0	12	W	RMI	BNA	0	0	0	FRAG	1991 S
19	243	0	0	0	12	W	QUARS	BNA	0	0	0	FRAG	1991 S
19	244	0	0	0	14	E	SORRENCA	BNA	0	0	0	FRAG	1991 S
19	245	0	0	0	14	E	RMI	BNA	0	0	0		1991 S
19	246	0	0	0	14	W	QUARS	BNA	0	0	0	FRAC	1991 S
19	247	0	0	0	14	W	RMI	BNA	0	0	0	FRAC	1991 S
19	248	0	0	0	14	W	QUARS	BNA	0	0	0	FRAG	1991 S
19	249	0	0	0	14	W	QUARSITA	BN2G	0	0	0	DESTRAL	1991 S
19	250	0	0	0	14	W	CONGLOME	BNA	0	0	0	2 FRAGS N.G.	1991 S
19	251	0	0	0	14	W	RMI	BNA	0	0	0	FRAG	1991 S
19	252	0	0	0	14	W	RMI	BNA	0	0	0	FRAG N.G.	1991 S
19	253	0	0	0	14	W	RMI	BNA	0	0	0	FRAG	1991 S
19	254	0	0	0	14	W	RMI	BNA	0	0	0	N.G.	1991 S
19	255	0	0	0	15	E	GRANIT	BNA	0	0	0	FRAC	1991 S
19	256	0	0	0	15	E	RMI	BNA	0	0	0	FRAG	1991 S
19	257	0	0	0	15	E	RMI	BNA	0	0	0		1991 S
19	258	0	0	0	15	E	QUARS	BNA	0	0	0		1991 S
19	259	0	0	0	15	E	CONGLOME	BNA	0	0	0		1991 S
19	260	0	0	0	15	E	SORRENCA	BNA	0	0	0		1991 S
19	261	0	0	0	15	W	QUARSITA	BNA	0	0	0		1991 S
19	262	0	0	0	15	W	SORRENCA	BNA	0	0	0	FRAG	1991 S
19	263	0	0	0	15	W	RMI	BNA	0	0	0		1991 S
19	264	0	0	0	12	W	CALCARIA	BNA	0	0	0		1991 S
19	265	0	0	0	13	E	RMI	BNA	0	0	0	FRAG N.G.	1991 S
19	266	0	0	0	13	W	CALCARIA	BNA	0	0	0	N.G.	1991 S
19	267	0	0	0	15	W	SORRENCA	BNA	0	0	0	FRAG	1991 S
19	268	0	0	0	15	W	RMI	BNA	0	0	0	FRAG N.G.	1991 S
19	269	0	0	0	15	W	RMI	BNA	0	0	0		1991 S
19	270	0	0	0	15	W	CALCARIA	BNA	0	0	0	N.G.	1991 S
19	271	0	0	0	15	W	CONGLOME	BNA	0	0	0	N.G.	1991 S

BOBILA MADURELL  
MAS DURAN  
campanya 1991

E.E. NUM.	X	Y	Zsup	Zinf/ Talla	ORIENT	PENDENT SECTOR	MATERIA	OBJECTE	LONG	AMPL	ESPE	ALTERACIONS	P D
												OBSERVACIONS	ANY U I N B T U
19	272	0	0	0	15	W	CALCARIA	BMA	0	0	0		1991 S
19	273	0	0	0	15	W	CONGLOME	BMA	0	0	0	FRAG	1991 S
19	274	0	0	0	15	W	SORRENCA	BMA	0	0	0		1991 S
19	275	0	0	0	15	W	RMI	BMA	0	0	0	FRAG	1991 S
19	276	0	0	0	10	E	OS	INDET	0	0	0		1991 S
19	277	0	0	0	10	E	OS	DET	0	0	0		1991 S
19	278	0	0	0	9	E	OS	INDET	0	0	0		1991 S
19	279	0	0	0	10	W	OS	DET	0	0	0	DENT	1991 S
19	280	0	0	0	10	W	OS	INDET	0	0	0		1991 S
19	281	0	0	0	10	W	OS	DET	0	0	0		1991 S
19	282	0	0	0	11	E	OS	INDET	0	0	0		1991 S
19	283	0	0	0	11	E	OS	INDET	0	0	0		1991 S
19	284	0	0	0	11	W	OS	INDET	0	0	0		1991 S
19	285	0	0	0	11	W	OS	INDET	0	0	0	2 FRAGS	1991 S
19	286	0	0	0	11	W	OS	INDET	0	0	0	3 FRAGS	1991 S
19	287	0	0	0	12	E	OS	INDET	0	0	0		1991 S
19	288	0	0	0	12	E	OS	INDET	0	0	0	2 FRAGS	1991 S
19	289	0	0	0	9	E	OS	INDET	0	0	0		1991 S
19	290	0	0	0	12	W	OS	INDET	0	0	0		1991 S
19	291	0	0	0	12	W	OS	DET	0	0	0	DENT	1991 S
19	292	0	0	0	12	W	OS	DET	0	0	0	MD	1991 S
19	293	0	0	0	12	W	OS	DET	0	0	0		1991 S
19	294	0	0	0	12	W	OS	INDET	0	0	0	VARIS FRAGS	1991 S
19	295	0	0	0	13	W	OS	INDET	0	0	0		1991 S
19	296	0	0	0	13	W	OS	DET	0	0	0	VARIS FRAGS	1991 S
19	297	0	0	0	13	W	OS	INDET	0	0	0		1991 S
19	298	0	0	0	14	E	OS	DET	0	0	0		1991 S
19	299	0	0	0	14	E	OS	DET	0	0	0		1991 S
19	300	0	0	0	14	E	OS	DET	0	0	0		1991 S
19	301	0	0	0	14	W	OS	DET	0	0	0	VARIS FRAGS	1991 S
19	302	0	0	0	14	W	OS	INDET	0	0	0		1991 S
19	303	0	0	0	14	W	OS	DET	0	0	0		1991 S
19	304	0	0	0	14	W	OS	INDET	0	0	0		1991 S
19	305	0	0	0	14	W	OS	INDET	0	0	0		1991 S
19	306	0	0	0	14	W	OS	DET	0	0	0		1991 S
19	307	0	0	0	14	W	OS	DET	0	0	0	VARIS FRAGS	1991 S
19	308	0	0	0	14	W	OS	INDET	0	0	0	CREMAT	1991 S
19	309	0	0	0	14	W	OS	INDET	0	0	0	2 FRAGS	1991 S
19	310	0	0	0	14	W	OS	DET	0	0	0	AST VARIS FRAGS	1991 S
19	311	0	0	0	14	W	OS	INDET	0	0	0	VARIS FRAGS	1991 S
19	312	0	0	0	15	E	OS	INDET	0	0	0		1991 S
19	313	0	0	0	15	E	OS	DET	0	0	0		1991 S
19	314	0	0	0	15	E	OS	DET	0	0	0	VARIS FRAGS	1991 S
19	315	0	0	0	15	E	OS	INDET	0	0	0		1991 S
19	316	0	0	0	15	E	OS	DET	0	0	0	3 FRAGS	1991 S
19	317	0	0	0	15	E	OS	DET	0	0	0		1991 S
19	318	0	0	0	15	E	OS	DET	0	0	0		1991 S
19	319	0	0	0	15	E	OS	DET	0	0	0	VARIS FRAGS	1991 S
19	320	0	0	0	15	E	OS	INDET	0	0	0	VARIS FRAGS	1991 S
19	321	0	0	0	15	E	OS	INDET	0	0	0	2 FRAGS	1991 S
19	322	0	0	0	15	W	OS	INDET	0	0	0	VARIS FRAGS	1991 S



BOBILA MADURELL  
MAS DURAN  
campanya 1991

E.E. NUM.	X	Y	Zsup	Zinf/ Talla	ORIENT	PENDENT SECTOR	MATERIA	OBJECTE	LONG	AMPL	ESPE	ALTERACIONS OBSERVACIONS	P D				
													ANY	U	I		
19	323	0	0	0	15	W	OS	INDET	0	0	0	VARIS FRAGS	1991	S			
19	324	0	0	0	15	W	OS	INDET	0	0	0	VARIS FRAGS	1991	S			
19	325	0	0	0	15	W	OS	INDET	0	0	0		1991	S			
19	326	0	0	0	15	W	OS	DET	0	0	0	POLIT	1991	S			
19	327	0	0	0	15	W	OS	DET	0	0	0	VARIS FRAGS	1991	S			
19	329	0	0	0	15	W	OS	DET	0	0	0	DENT	1991	S			
19	330	0	0	0	15	W	OS	INDET	0	0	0	2 FRAGS	1991	S			
19	331	0	0	0	15	W	OS	INDET	0	0	0		1991	S			
19	332	0	0	0	15	W	OS	INDET	0	0	0		1991	S			
19	333	0	0	0	15	W	ORGANIC	MOLUSC	0	0	0	PETXINA PERFORA	1991	S			
M10	1	0	0	0	1710	NW-SE	SE	OS	DET	0	0	0	CST 2 FRAGS	1991	S		
M10	2	0	0	0	1690			OS	INDET	0	0	0	FRAC	1991	S		
M10	3	0	0	0	1710			CERAMICA	INFORME	0	0	0		1991	S		
M10	4	0	0	0	1745			CERAMICA	INFORME	0	0	0		1991	S		
M10	5	0	0	0	1745	N-S	S	OS	INDET	0	0	0		1991	S		
M10	6	0	0	0	1730	E-W	W	CERAMICA	INFORME	0	0	0	2 FRAGS	1991	S		
M10	7	0	0	0	1730			QUARS	BPF	0	0	0		1991	S		
M10	8	0	0	0	1760			CALAITA	DENA	0	0	0		1991	S		
M10	9	0	0	0	1760			CALAITA	DENA	0	0	0		1991	S		
M10	10	0	0	0	1760			CALAITA	DENA	0	0	0		1991	S		
M10	11	0	0	0	1760			CALAITA	DENA	0	0	0		1991	S		
M10	12	0	0	0	1770			CALAITA	DENA	0	0	0		1991	S		
M10	13	0	0	0	1770			CALAITA	DENA	0	0	0		1991	S		
M10	14	0	0	0	1770			CALAITA	DENA	0	0	0		1991	S		
M10	15	0	0	0	1760			CALAITA	DENA	0	0	0		1991	S		
M10	16	0	0	0	1775			CALAITA	DENA	0	0	0		1991	S		
M10	17	0	0	0	1771			OS	DET	0	0	0	FA	1991	S		
M10	18	0	0	0	1860			OS	INDET	0	0	0		1991	S		
M10	19	0	0	0	1774			OS	BN2G	0	0	0	PUNXO MPa	1991	S		
M10	20	0	0	0	1768			OS	INDET	0	0	0		1991	S		
M10	21	0	0	0	1795			OS	DET	0	0	0	FRAG CST	1991	S		
M10	22	0	0	0	1794			OS	DET	0	0	0	FRAG CST	1991	S		
M10	23	0	0	0	1796			OS	DET	0	0	0	FRAG CST	1991	S		
M10	24	0	0	0	1797			OS	DET	0	0	0	2 FRAGS CST	1991	S		
M10	25	0	0	0	1796			OS	DET	0	0	0	FRAG CST	1991	S		
M10	26	0	0	0	1797			OS	DET	0	0	0	FE ED cap el SE	1991	S		
M10	27	0	0	0	1795			OS	DET	0	0	0	TI ED cap el SE	1991	S		
M10	28	0	0	0	1792			OS	DET	0	0	0	ED cap el NW	1991	S		
M10	29	0	0	0	1790			OS	DET	0	0	0	ED cap el NW	1991	S		
M10	30	0	0	0	1795			OS	DET	0	0	0	FRAG CST	1991	S		
M10	31	0	0	0	1722			OS	DET	0	0	0	DENT	1991	S		
M10	32	0	0	0	1782			OS	DET	0	0	0	FRAG CRA	1991	S		
M10	33	0	0	0	1782			OS	DET	0	0	0	FRAG CRA	1991	S		
M10	34	0	0	0	1736			OS	DET	0	0	0	DENT	1991	S		
M10	35	0	0	1690	1750			CONGLOME	BNA	0	0	0		1991	S		
M10	36	0	0	0	1796			CALAITA	DENA	0	0	0		1991	S		
M10	37	0	0	0	1796			OS	DET	0	0	0	CRA RESTAURAR	1991	S		
M10	38	0	0	0	18		E	CERAMICA	INFORME	0	0	0		1991	S		
M10	39	0	0	0	18		E	CERAMICA	INFORME	0	0	0		1991	S		
M11	1	0	0	0	1890			OS	INDET	0	0	0		1991	S		
M11	2	0	0	0	1820			OS	INDET	0	0	0		1991	S		

BOBILA MADURELL  
MAS DURAN  
campanya 1991

E.E. NUM.	X	Y	Zsup	Zinf/ Talla	ORIENT SECTOR	PENDENT	MATERIA	OBJECTE	LONG	AMPL	ESPE	ALTERACIONS	P D
												OBSERVACIONS	
M11	3	0	0	0	1870		CERAMICA	INFORME	0	0	0		1991 S
M11	4	0	0	0	1880		CERAMICA	INFORME	0	0	0		1991 S
M11	5	0	0	0	1890		CERAMICA	INFORME	0	0	0		1991 S
M11	6	0	0	0	1890		OS	DET	0	0	0		1991 S
M11	7	0	0	0	1820		OS	DET	0	0	0		1991 S
M11	8	0	0	0	1820		OS	DET	0	0	0		1991 S
M11	9	0	0	0	1930		CERAMICA	INFORME	0	0	0		1991 S
M11	10	0	0	0	1980		SILEX	BPF	0	0	0		1991 S
M11	11	0	0	0	1980		OS	DET	0	0	0	DENT I?	1991 S
M11	12	0	0	0	1980		OS	DET	0	0	0		1991 S
M11	13	0	0	0	1970		OS	DET	0	0	0	VARIS FRAGS	1991 S
M11	14	0	0	0	1990		OS	DET	0	0	0		1991 S
M11	15	0	0	0	1970		OS	DET	0	0	0	FA D	1991 S
M11	16	0	0	0	1985		OS	DET	0	0	0	MC D	1991 S
M11	17	0	0	0	1955		OS	DET	0	0	0	EI	1991 S
M11	18	0	0	0	1980		OS	DET	0	0	0	MC	1991 S
M11	19	0	0	0	1990		OS	DET	0	0	0		1991 S
M11	20	0	0	0	2000		OS	DET	0	0	0		1991 S
M11	21	0	0	0	2100		OS	DET	0	0	0	MC?	1991 S
M11	22	0	0	0	1990		OS	DET	0	0	0	FRAG E	1991 S
M11	23	0	0	0	2000		OS	DET	0	0	0	VARIS FRAGS	1991 S
M11	24	0	0	0	1960		OS	DET	0	0	0	FE D Lat Ext	1991 S
M11	25	0	0	0	2030		OS	DET	0	0	0	CB E Lat Ext?	1991 S
M11	26	0	0	0	2030		OS	DET	0	0	0	RA E Lat Ext?	1991 S
M11	27	0	0	0	2010		OS	DET	0	0	0	HU E RESTAURAR	1991 S
M11	28	0	0	0	2000		OS	DET	0	0	0	TI D Lat Ext	1991 S
M11	29	0	0	0	2000		OS	DET	0	0	0	PR D Lat Ext	1991 S
M11	30	0	0	0	2030		OS	DET	0	0	0	TI E Lat Int	1991 S
M11	31	0	0	0	2030		OS	DET	0	0	0	PR E Lat Int	1991 S
M11	32	0	0	0	1990		OS	DET	0	0	0	FA	1991 S
M11	33	0	0	0	2030		OS	DET	0	0	0	FE RESTAURAR	1991 S
M11	34	0	0	0	2000		OS	DET	0	0	0	HU D RESTAURAR	1991 S
M11	35	0	0	0	2000		OS	DET	0	0	0	RESTAURAR	1991 S
M11	36	0	0	0	2000		SILEX	BP	0	0	0	LAMIN SOTA HU D	1991 S
M11	37	0	0	0	2020		SILEX	BP	0	0	0	LAMIN SOTA HU E	1991 S
M11	38	0	0	0	2010		CALAITA	DENA	0	0	0		1991 S
M11	39	0	0	0	2030		OS	DET	0	0	0	DENT	1991 S
M11	40	0	0	0	2040		RMI	BNA	0	0	0	FRAG	1991 S
M11	41	0	0	0	1905	NW-SE	OS	DET	0	0	0	ED cap el SE	1991 S
M11	42	0	0	0	1900	NW-SE	OS	DET	0	0	0	MP MA E	1991 S
M11	43	0	0	0	2010	E-W	OS	DET	0	0	0	MP MA E	1991 S
M11	44	0	0	0	2000	N-S	OS	DET	0	0	0	MP MA E	1991 S
M11	45	0	0	0	2000	E-W	OS	DET	0	0	0	FRAG E D	1991 S
M11	46	0	0	0	2020		CERAMICA	VAS	0	0	0	VARIS FRAGS	1991 S
M11	47	0	0	0	1910	E-W	OS	DET	0	0	0	FRAG MP	1991 S
M11	48	0	0	0	1920	NW-SE	OS	DET	0	0	0	DENT	1991 S
M11	49	0	0	0	1960	NE-SW	SERPENTI	BNE	0	0	0	DESTRAL	1991 S
M11	50	0	0	0	2000	E-W	SILEX	BN2G	0	0	0	LAMINA	1991 S
M11	51	0	0	0	17		CERAMICA	INFORME	0	0	0		1991 S
M11	52	0	0	0	19		CERAMICA	INFORME	0	0	0		1991 S
M11	53	0	0	0	19		CERAMICA	INFORME	0	0	0		1991 S

BOBILA MADURELL  
MAS DURAN  
campanya 1991

E.E. NUM.	X	Y	Zsup	Zinf/ Talla	ORIENT	PENDENT SECTOR	MATERIA	OBJECTE	LONG	AMPL	ESPE	ALTERACIONS	P D
												OBSERVACIONS	ANY U I N B T U
M11	54	0	0	0	20	E	CERAMICA	INFORME	0	0	0		1991 S
M11	55	0	0	0	20	W	CERAMICA	INFORME	0	0	0		1991 S
M11	56	0	0	0	20	W	CERAMICA	INFORME	0	0	0		1991 S
M11	57	0	0	0	19		OS	INDET	0	0	0		1991 S
M11	58	0	0	0	19		OS	INDET	0	0	0		1991 S
M11	59	0	0	0	19		OS	INDET	0	0	0		1991 S
M12	1	0	0	0	13	W	CERAMICA	APLICA	0	0	0	MUGRO	1991 S
M12	2	0	0	0	13	E	OS	INDET	0	0	0		1991 S
M12	3	0	0	0	13	E	OS	INDET	0	0	0		1991 S
M12	4	0	0	0	13	E	OS	INDET	0	0	0		1991 S
M12	5	0	0	0	13	E	OS	INDET	0	0	0		1991 S
M12	6	0	0	0	13	E	OS	DET	0	0	0	FRAG DENT	1991 S
M12	7	0	0	0	13	E	OS	INDET	0	0	0		1991 S
M12	8	0	0	0	13	E	OS	DET	0	0	0		1991 S
M12	9	0	0	0	13	E	OS	INDET	0	0	0		1991 S
M12	10	0	0	0	13	W	OS	DET	0	0	0	FRAG CST	1991 S
M12	11	0	0	0	13	W	OS	INDET	0	0	0		1991 S
M12	12	0	0	0	13	W	OS	INDET	0	0	0		1991 S
M12	13	0	0	0	13	W	OS	DET	0	0	0	2 CST	1991 S
M12	14	0	0	0	13	W	OS	INDET	0	0	0		1991 S
M12	15	0	0	0	13		SILEX	BP	0	0	0	LAMINA	1991 S
M13	1	0	0	0	14		CERAMICA	INFORME	0	0	0	SUPERFICIE	1991 S
M13	2	0	0	0	14		CERAMICA	INFORME	0	0	0	SUPERFICIE	1991 S
M13	3	0	0	0	15	E	CERAMICA	INFORME	0	0	0		1991 S
M13	4	0	0	0	15	E	CERAMICA	INFORME	0	0	0	3 FRAGS	1991 S
M13	5	0	0	0	15	E	OS	INDET	0	0	0		1991 S
M14	1	0	0	0	1380		OS	DET	0	0	0	DENT	1991 S
M14	2	0	0	0	1380		OS	DET	0	0	0	DENT	1991 S
M14	3	0	0	0	1390		ORGANIC	MOLUSC	0	0	0		1991 S
M14	4	0	0	0	1400		SILEX	BP	0	0	0		1991 S
M14	5	0	0	0	1395		OS	INDET	0	0	0		1991 S
M14	6	0	0	0	1430		OS	DET	0	0	0	DENT	1991 S
M14	7	0	0	1320	1400		OS	DET	0	0	0	CRA INFANTIL	1991 S
M15	1	0	0	0	2270		GRANIT	BNA	0	0	0		1991 S
M15	2	0	0	0	2297		RMI	BNA	0	0	0	FRAG	1991 S
M15	3	0	0	0	2300		CALCARIA	BNA	0	0	0	FRAG N.G.	1991 S
M15	4	0	0	0	2280		RMI	BNA	0	0	0	FRAG N.G.	1991 S
M15	5	0	0	0	2295		GRANIT	BNA	0	0	0	FRAG N.G.	1991 S
M15	6	0	0	0	2323		RMI	BNA	0	0	0		1991 S
M15	7	0	0	0	2310		RMI	BNA	0	0	0	FRAG	1991 S
M15	8	0	0	0	2322		CALCARIA	BNA	0	0	0		1991 S
M15	9	0	0	0	2317		SILEX	BP	0	0	0	TRAPECI	1991 S
M15	10	0	0	0	2323		SILEX	BN2G	0	0	0	TRAPECI	1991 S
M15	11	0	0	0	2328		SILEX	BP	0	0	0	LAMINA	1991 S
M15	12	0	0	0	2323		CALAITA	DENA	0	0	0		1991 S
M15	13	0	0	0	2326		CALAITA	DENA	0	0	0		1991 S
M15	14	0	0	0	2326		CALAITA	DENA	0	0	0		1991 S
M15	15	0	0	0	2326		CALAITA	DENA	0	0	0		1991 S
M15	16	0	0	0	2328		CALAITA	DENA	0	0	0		1991 S
M15	17	0	0	0	2328		CALAITA	DENA	0	0	0		1991 S
M15	18	0	0	0	2328		CALAITA	DENA	0	0	0		1991 S

BOBILA MADURELL  
MAS DURAN  
campanya 1991

E.E. NUM.	X	Y	Zsup	Zinf/ Talla	ORIENT PENDENT SECTOR	MATERIA	OBJECTE	LONG	AMPL	ESPE	ALTERACIONS	P D
											OBSERVACIONS	ANY U I N B T U
M15	19	0	0	0	2328	CALAITA	DENA	0	0	0		1991 S
M15	20	0	0	0	2315	SILEX	BP	0	0	0	LAMINA	1991 S
M15	21	0	0	0	2323	CALAITA	DENA	0	0	0		1991 S
M15	22	0	0	0	2323	CALAITA	DENA	0	0	0		1991 S
M15	23	0	0	0	2325	CALAITA	DENA	0	0	0		1991 S
M15	24	0	0	0	2325	CALAITA	DENA	0	0	0		1991 S
M15	25	0	0	0	2310	OS	DET	0	0	0	FRAG PEU E	1991 S
M15	26	0	0	0	2315	OS	INDET	0	0	0		1991 S
M15	27	0	0	0	2350	OS	DET	0	0	0	CST E	1991 S
M15	28	0	0	0	2350	OS	DET	0	0	0	CST E	1991 S
M15	29	0	0	0	2360	OS	DET	0	0	0		1991 S
M15	30	0	0	0	2305	OS	DET	0	0	0	FE D	1991 S
M15	31	0	0	0	2320	OS	DET	0	0	0	TI D	1991 S
M15	32	0	0	0	2320	OS	DET	0	0	0	PR D	1991 S
M15	33	0	0	0	2320	OS	DET	0	0	0	FRAG PEL	1991 S
M15	34	0	0	0	2330	OS	DET	0	0	0	FRAG PEL	1991 S
M15	35	0	0	0	2320	OS	DET	0	0	0	FE E	1991 S
M15	36	0	0	0	2615	OS	DET	0	0	0	TI E	1991 S
M15	37	0	0	0	2315	OS	DET	0	0	0	PR E	1991 S
M15	38	0	0	0	2325	OS	DET	0	0	0	RA E	1991 S
M15	39	0	0	0	2315	OS	DET	0	0	0	CB E	1991 S
M15	40	0	0	0	2330	OS	DET	0	0	0	HU E	1991 S
M15	41	0	0	0	2316	SILEX	BP	0	0	0	LAMINA	1991 S
M15	42	0	0	0	2328	OS	DET	0	0	0	CL E	1991 S
M15	43	0	0	0	2328	CALAITA	DENA	0	0	0		1991 S
M15	44	0	0	0	2328	CALAITA	DENA	0	0	0		1991 S
M15	45	0	0	0	2329	CALAITA	DENA	0	0	0		1991 S
M15	46	0	0	0	2327	CALAITA	DENA	0	0	0		1991 S
M15	47	0	0	0	2327	CALAITA	DENA	0	0	0		1991 S
M15	48	0	0	0	2327	CALAITA	DENA	0	0	0		1991 S
M15	49	0	0	0	2327	CALAITA	DENA	0	0	0		1991 S
M15	50	0	0	0	2327	CALAITA	DENA	0	0	0		1991 S
M15	51	0	0	0	2327	CALAITA	DENA	0	0	0		1991 S
M15	52	0	0	0	2327	CALAITA	DENA	0	0	0		1991 S
M15	53	0	0	0	2327	CALAITA	DENA	0	0	0		1991 S
M15	54	0	0	0	2327	CALAITA	DENA	0	0	0		1991 S
M15	55	0	0	0	2327	CALAITA	DENA	0	0	0		1991 S
M15	56	0	0	0	2327	CALAITA	DENA	0	0	0		1991 S
M15	57	0	0	0	2320	CALAITA	DENA	0	0	0		1991 S
M15	58	0	0	0	2350	OS	DET	0	0	0	CST E	1991 S
M15	59	0	0	0	2330	CALAITA	DENA	0	0	0		1991 S
M15	60	0	0	0	2330	OS	INDET	0	0	0		1991 S
M15	61	0	0	0	2320	OS	DET	0	0	0	HU D	1991 S
M15	62	0	0	0	2320	OS	DET	0	0	0	CB D	1991 S
M15	63	0	0	0	2320	OS	DET	0	0	0	RA D	1991 S
M15	64	0	0	0	2320	OS	DET	0	0	0		1991 S
M15	65	0	0	0	2320	OS	DET	0	0	0		1991 S
M15	66	0	0	0	2330	OS	DET	0	0	0	FRAG PEL	1991 S
M15	67	0	0	0	2320	CALAITA	DENA	0	0	0		1991 S
M15	68	0	0	0	2320	CALAITA	DENA	0	0	0		1991 S
M15	69	0	0	0	2320	CALAITA	DENA	0	0	0		1991 S

BOBILA MADURELL  
MAS DURAN  
campanya 1991

E.E. NUM.	X	Y	Zsup	Zinf/ Talla	ORIENT	PENDENT SECTOR	MATERIA	OBJECTE	LONG	AMPL	ESPE	ALTERACIONS	P D
												OBSERVACIONS	ANY U I N B T U
M15	70	0	0	0	2320		CALAITA	DENA	0	0	0		1991 S
M15	71	0	0	0	2320		CALAITA	DENA	0	0	0		1991 S
M15	72	0	0	0	2320		CALAITA	DENA	0	0	0		1991 S
M15	73	0	0	0	2320		CALAITA	DENA	0	0	0		1991 S
M15	74	0	0	0	2320		CALAITA	DENA	0	0	0		1991 S
M15	75	0	0	0	2320		CALAITA	DENA	0	0	0	FRAG	1991 S
M15	76	0	0	0	2320		CALAITA	DENA	0	0	0		1991 S
M15	77	0	0	0	2320		CALAITA	DENA	0	0	0		1991 S
M15	78	0	0	0	2320		CALAITA	DENA	0	0	0		1991 S
M15	79	0	0	0	2320		CALAITA	DENA	0	0	0		1991 S
M15	80	0	0	0	2320		CALAITA	DENA	0	0	0		1991 S
M15	81	0	0	0	2320		CALAITA	DENA	0	0	0		1991 S
M15	82	0	0	0	2330		OS	DET	0	0	0	VARIS CST D	1991 S
M15	83	0	0	0	2320		OS	INDET	0	0	0		1991 S
M15	84	0	0	0	2320		CALAITA	DENA	0	0	0		1991 S
M15	85	0	0	0	2325		CALAITA	DENA	0	0	0		1991 S
M15	86	0	0	0	2325		CALAITA	DENA	0	0	0		1991 S
M15	87	0	0	0	2325		CALAITA	DENA	0	0	0		1991 S
M15	88	0	0	0	2325		CALAITA	DENA	0	0	0		1991 S
M15	89	0	0	0	2325		CALAITA	DENA	0	0	0		1991 S
M15	90	0	0	0	2330		CALAITA	DENA	0	0	0		1991 S
M15	91	0	0	0	2330		CALAITA	DENA	0	0	0		1991 S
M15	92	0	0	0	2330		CALAITA	DENA	0	0	0		1991 S
M15	93	0	0	0	2335		CALAITA	DENA	0	0	0		1991 S
M15	94	0	0	0	2340		CALAITA	DENA	0	0	0		1991 S
M15	95	0	0	0	2340		OS	DET	0	0	0	CRA	1991 S
M15	96	0	0	0	2330		CALAITA	DENA	0	0	0		1991 S
M15	97	0	0	0	2330		CALAITA	DENA	0	0	0		1991 S
M15	98	0	0	0	2330		CALAITA	DENA	0	0	0		1991 S
M15	99	0	0	0	2330		CALAITA	DENA	0	0	0		1991 S
M15	100	0	0	0	2330		CALAITA	DENA	0	0	0		1991 S
M15	101	0	0	0	2330		CALAITA	DENA	0	0	0		1991 S
M15	102	0	0	0	2330		CALAITA	DENA	0	0	0		1991 S
M15	103	0	0	0	2340		CALAITA	DENA	0	0	0		1991 S
M15	104	0	0	0	2340		OS	DET	0	0	0	VARIS VT	1991 S
M15	105	0	0	0	2360		SILEX	BP	0	0	0	TRAPECI	1991 S
M15	106	0	0	0	2360		CERAMICA	VAS	0	0	0	SENCERA	1991 S
M15	107	0	0	0	15	E	CERAMICA	INFORME	0	0	0		1991 S
M15	108	0	0	0	15	W	CERAMICA	INFORME	0	0	0		1991 S
M15	109	0	0	0	16	E	CERAMICA	INFORME	0	0	0	VARIS FRAGS	1991 S
M15	110	0	0	0	16	W	CERAMICA	INFORME	0	0	0		1991 S
M15	111	0	0	0	16	W	CERAMICA	INFORME	0	0	0		1991 S
M15	112	0	0	0	16	W	CERAMICA	INFORME	0	0	0		1991 S
M15	113	0	0	0	17	W	CERAMICA	INFORME	0	0	0		1991 S
M15	114	0	0	0	17	W	CERAMICA	INFORME	0	0	0		1991 S
M15	115	0	0	0	17	W	CERAMICA	INFORME	0	0	0		1991 S
M15	116	0	0	0	18	W	CERAMICA	INFORME	0	0	0		1991 S
M15	117	0	0	0	19	W	CERAMICA	INFORME	0	0	0		1991 S
M15	118	0	0	0	21	E	CERAMICA	VORA	0	0	0		1991 S
M15	119	0	0	0	21	E	CERAMICA	INFORME	0	0	0		1991 S
M15	120	0	0	0	21	E	CERAMICA	INFORME	0	0	0		1991 S

BOBILA MADURELL  
MAS DURAN  
campanya 1991

E.E. NUM.	X	Y	Zsup	Zinf/ Talla	ORIENT	PENDENT SECTOR	MATERIA	OBJECTE	LONG	AMPL	ESPE	ALTERACIONS	P D	
												OBSERVACIONS		ANY U I N B T U
M15	121	0	0	0	21	W	CERAMICA	INFORME	0	0	0		1991 S	
M15	122	0	0	0	21	W	CERAMICA	INFORME	0	0	0		1991 S	
M15	123	0	0	0	21	W	CERAMICA	INFORME	0	0	0		1991 S	
M15	124	0	0	0	21	W	CERAMICA	INFORME	0	0	0		1991 S	
M15	125	0	0	0	21	W	CERAMICA	INFORME	0	0	0		1991 S	
M15	126	0	0	0	22	E	CERAMICA	INFORME	0	0	0		1991 S	
M15	127	0	0	0	22	W	CERAMICA	INFORME	0	0	0		1991 S	
M15	128	0	0	0	23	W	CERAMICA	INFORME	0	0	0		1991 S	
M15	129	0	0	0	23	W	CERAMICA	INFORME	0	0	0	VARIS FRAGS	1991 S	
M15	130	0	0	0	23	W	CERAMICA	INFORME	0	0	0		1991 S	
M15	131	0	0	0	15		CERAMICA	INFORME	0	0	0	SUPERFICIAL	1991 S	
M15	132	0	0	0	15		CERAMICA	INFORME	0	0	0	SUPERFICIAL	1991 S	
M15	133	0	0	0	21		QUARS	BPF	0	0	0		1991 S	
M15	134	0	0	0	17		CALCARIA	BNA	0	0	0		1991 S	
M15	135	0	0	0	17		QUARS	BNA	0	0	0	N.G.	1991 S	
M15	136	0	0	0	18		RMI	BNA	0	0	0	N.G.	1991 S	
M15	137	0	0	0	21		GRANIT	BNA	0	0	0	FRAG N.G.	1991 S	
M15	138	0	0	0	16	E	OS	INDET	0	0	0		1991 S	
M15	139	0	0	0	17	E	OS	DET	0	0	0		1991 S	
M15	140	0	0	0	17	E	OS	INDET	0	0	0		1991 S	
M15	141	0	0	0	19	E	OS	DET	0	0	0	VT	1991 S	
M15	142	0	0	0	19	E	OS	DET	0	0	0	VT	1991 S	
M15	143	0	0	0	20	E	OS	DET	0	0	0		1991 S	
M15	144	0	0	0	21	E	OS	DET	0	0	0		1991 S	
M15	145	0	0	0	21	E	OS	DET	0	0	0		1991 S	
M15	146	0	0	0	21	W	OS	DET	0	0	0	DET?	1991 S	
M15	147	0	0	0	21	W	OS	DET	0	0	0	FRAG DENT	1991 S	
M15	148	0	0	0	21	W	OS	DET	0	0	0	FRAG MD	1991 S	
M15	149	0	0	0	22	E	OS	INDET	0	0	0		1991 S	
M15	150	0	0	0	22	W	OS	DET	0	0	0	DET?	1991 S	
M15	151	0	0	0	0	W	OS	DET	0	0	0	DET?	1991 S	
M15	152	0	0	0	20	W	OS	DET	0	0	0	FRAG E	1991 S	
M15	153	0	0	0	0		CALAITA	DENA	0	0	0	4 DENES	1991 S	
M16	1	0	0	0	1205		OS	DET	0	0	0		1991 S	
M16	2	0	0	0	1360	NE-SW	V	CONGLOME	BNA	0	0	0	FRAG MICROCONGL	1991 S
M16	3	0	0	0	1330		RMI	BNA	0	0	0	FRAG	1991 S	
M16	4	0	0	0	1340	E-W	V	CONGLOME	BNA	0	0	0	FRAG MICROCONGL	1991 S
M16	5	0	0	0	1340	NE-SW	S	RMI	BNA	0	0	0	FRAG	1991 S
M16	6	0	0	0	1360	NE-SW	N	SORRENCA	BNA	0	0	0		1991 S
M16	7	0	0	0	1330	E-W	NE	QUARS	BNA	0	0	0		1991 S
M16	8	0	0	0	1370	N-S	V	RMI	BNA	0	0	0	FRAG	1991 S
M16	9	0	0	0	1340		P	RMI	BNA	0	0	0	FRAG	1991 S
M16	10	0	0	0	1350		P	CERAMICA	INFORME	0	0	0		1991 S
M16	11	0	0	0	1340		OS	DET	0	0	0	CL D Lat Ant	1991 S	
M16	12	0	0	0	1330		OS	DET	0	0	0	E E Lat Ant	1991 S	
M16	13	0	0	0	1335		OS	DET	0	0	0	HU D RESTAURAR	1991 S	
M16	14	0	0	0	1350		OS	DET	0	0	0	E D RESTAURAR	1991 S	
M16	15	0	0	0	1330		SILEX	BP	0	0	0	LAMINA	1991 S	
M16	16	0	0	0	1310		OS	DET	0	0	0	RA D	1991 S	
M16	17	0	0	0	1330		OS	DET	0	0	0	CB D	1991 S	
M16	18	0	0	0	1360		OS	DET	0	0	0	MC MA E	1991 S	

BOBILA MADURELL  
MAS DURAN  
campanya 1991

E.E. NUM.	X	Y	Zsup	Zinf/ Talla	ORIENT	PENDENT SECTOR	MATERIA	OBJECTE	LONG	AMPL	ESPE	ALTERACIONS	P D
												OBSERVACIONS	
M16	19	0	0	0	1670		OS	DET	0	0	0	CST D	1991 S
M16	20	0	0	0	1370		OS	DET	0	0	0	CST E	1991 S
M16	21	0	0	0	1375		OS	DET	0	0	0	HU E Ant	1991 S
M16	22	0	0	0	1370		OS	DET	0	0	0	CB E Lat Ant	1991 S
M16	23	0	0	0	1360		OS	DET	0	0	0	RA E	1991 S
M16	24	0	0	0	1330		OS	DET	0	0	0	FA 1 MA D	1991 S
M16	25	0	0	0	1330		OS	DET	0	0	0	FE E Lat Ext	1991 S
M16	26	0	0	0	1330		OS	DET	0	0	0	PR E	1991 S
M16	27	0	0	0	1330		OS	DET	0	0	0	TI E	1991 S
M16	28	0	0	0	1325		OS	DET	0	0	0	PR D	1991 S
M16	29	0	0	0	1325		OS	DET	0	0	0	FE D RESTAURAR	1991 S
M16	30	0	0	0	1325		OS	DET	0	0	0	TI E RESTAURAR	1991 S
M16	31	0	0	0	1327		OS	DET	0	0	0	PEU E	1991 S
M16	32	0	0	0	1360		OS	DET	0	0	0	PEL RESTAURAR	1991 S
M16	33	0	0	0	1360		OS	DET	0	0	0	F MEDULAR	1991 S
M16	34	0	0	0	1380		OS	DET	0	0	0	FA 1 E Lat Ext	1991 S
M16	35	0	0	0	1342		OS	DET	0	0	0	FRAG PEL RESTAU	1991 S
M16	36	0	0	0	1340		OS	DET	0	0	0	CL E	1991 S
M16	37	0	0	0	1370		OS	DET	0	0	0	MC?	1991 S
M16	38	0	0	0	0		OS	DET	0	0	0	CRA RESTAURAR	1991 S
M16	39	0	0	0	12	E	CERAMICA	INFORME	0	0	0		1991 S
M16	40	0	0	0	12	E	CERAMICA	INFORME	0	0	0		1991 S
M16	41	0	0	0	12	E	CERAMICA	INFORME	0	0	0		1991 S
M16	42	0	0	0	12	W	CERAMICA	INFORME	0	0	0		1991 S
M16	43	0	0	0	13	E	CERAMICA	INFORME	0	0	0		1991 S
M16	44	0	0	0	13	E	CERAMICA	INFORME	0	0	0	VARIS FRAGS	1991 S
M16	45	0	0	0	13	W	CERAMICA	INFORME	0	0	0	VARIS FRAGS	1991 S
M16	46	0	0	0	12	E	CERAMICA	INFORME	0	0	0		1991 S
M16	47	0	0	0	14	E	CERAMICA	INFORME	0	0	0		1991 S
M16	48	0	0	0	11	W	OS	INDET	0	0	0		1991 S
M16	49	0	0	0	12	E	OS	DET	0	0	0		1991 S
M16	50	0	0	0	12	E	OS	INDET	0	0	0		1991 S
M16	51	0	0	0	12	W	OS	INDET	0	0	0	CREMAT	1991 S
M16	52	0	0	0	13	E	OS	INDET	0	0	0	VARIS FRAGS	1991 S
M16	53	0	0	0	13	E	OS	INDET	0	0	0	2 FRAGS	1991 S
M16	54	0	0	0	13	E	OS	DET	0	0	0	2 FRAGS	1991 S
M16	55	0	0	0	13	E	OS	INDET	0	0	0		1991 S
M16	56	0	0	0	13	E	OS	INDET	0	0	0	VARIS FRAGS	1991 S
M16	57	0	0	0	13	W	OS	INDET	0	0	0	VARIS FRAGS	1991 S
M16	58	0	0	0	13	W	OS	INDET	0	0	0		1991 S
M17	1	0	0	0	14	E	OS	INDET	0	0	0		1991 S
M17	2	0	0	0	14		OS	DET	0	0	0	VT	1991 S
M18	1	0	0	0	32	W	SILEX	BPF	0	0	0		1991 S
M18	2	0	0	0	32	W	SILEX	BPF	0	0	0		1991 S
M18	3	0	0	0	32		OS	DET	0	0	0	CRA OCND RESTAU	1991 S
M18	4	0	0	0	33	E	SORRENCA	BNA	0	0	0	N.G.	1991 S
M2	1	0	0	0	19	E	CONGLOME	BNA	0	0	0	FRAG N.G.	1991 S
M2	2	0	0	0	19	E	SORRENCA	BNA	0	0	0	FRAG N.G.	1991 S
M2	3	0	0	0	19	E	QUARS	BNA	0	0	0	FRAG N.G.	1991 S
M2	4	0	0	0	19	E	RMI	BNA	0	0	0		1991 S
M2	5	0	0	0	19	E	SORRENCA	BNE	0	0	0	FRAG MOLI	1991 S

BOBILA MADURELL  
MAS DURAN  
campanya 1991

E.E. NUM.	X	Y	Zsup	Zinf/ Talla	ORIENT	PENDENT SECTOR	MATERIA	OBJECTE	LONG	AMPL	ESPE	ALTERACIONS OBSERVACIONS	P D			
													ANY	U	I	
M2	6	0	0	0	19	E	SORRENCA	BNA	0	0	0	N.G.	1991	S		
M3	1	0	0	0	18		CERAMICA	INFORME	0	0	0	SUPERFICIAL	1991	S		
M3	2	0	0	0	19	E	CERAMICA	INFORME	0	0	0		1991	S		
M3	3	0	0	0	19	W	CERAMICA	INFORME	0	0	0		1991	S		
M3	4	0	0	0	20	E	CERAMICA	INFORME	0	0	0		1991	S		
M3	5	0	0	0	18		CERAMICA	INFORME	0	0	0	SUPERFICIAL	1991	S		
M3	6	0	0	0	18		CERAMICA	INFORME	0	0	0	SUPERFICIAL	1991	S		
M3	7	0	0	0	18		CERAMICA	NANSA	0	0	0	VARIS FRAGS	1991	S		
M3	8	0	0	0	18		RMI	BNA	0	0	0	FRAG SUPERFICIA	1991	S		
M3	9	0	0	0	18		RMI	BNA	0	0	0	FRAG N.G.	1991	S		
M3	10	0	0	0	19		RMI	BNA	0	0	0	N.G.	1991	S		
M3	11	0	0	0	19	W	SORRENCA	BNA	0	0	0	FRAG	1991	S		
M3	12	0	0	0	18		RMI	BNA	0	0	0	FRAG N.G.	1991	S		
M3	13	0	0	0	18		GRANIT	BNA	0	0	0	FRAG SUPERFICIE	1991	S		
M3	14	0	0	0	18		RMI	BNA	0	0	0	FRAC SUPERFICIE	1991	S		
M3	15	0	0	0	18		RMI	BNA	0	0	0	FRAC SUPERFICIE	1991	S		
M3	16	0	0	0	18		RMI	BNA	0	0	0	FRAG N.G.	1991	S		
M3	17	0	0	0	18		RMI	BNA	0	0	0	FRAG N.G.	1991	S		
M3	18	0	0	0	18		RMI	BNA	0	0	0	FRAG N.G.	1991	S		
M3	19	0	0	0	19		RMI	BNA	0	0	0	FRAG N.G.	1991	S		
M3	20	0	0	0	19	E	RMI	BNA	0	0	0	FRAG N.G.	1991	S		
M3	21	0	0	0	19	W	GRANIT	BNA	0	0	0	FRAG N.G.	1991	S		
M3	22	0	0	0	19	W	RMI	BNA	0	0	0	FRAG N.G.	1991	S		
M3	23	0	0	0	19	W	SORRENCA	BNA	0	0	0	FRAG N.G.	1991	S		
M4	1	0	0	0	19	E	CERAMICA	CARENA	0	0	0		1991	S		
M4	2	0	0	0	19	E	CERAMICA	INFORME	0	0	0	DECORA ESPIGUES	1991	S		
M4	3	0	0	0	20	E	CERAMICA	INFORME	0	0	0	2 FRAGS	1991	S		
M4	4	0	0	0	20	W	CERAMICA	INFORME	0	0	0		1991	S		
M4	5	0	0	0	20	W	CERAMICA	INFORME	0	0	0	2 FRAGS	1991	S		
M4	6	0	0	0	19		QUARS	BNA	0	0	0	FRAG N.G.	1991	S		
M4	7	0	0	0	19		SORRENCA	BNA	0	0	0	FRAG N.G.	1991	S		
M4	8	0	0	0	19	E	SORRENCA	BNA	0	0	0	FRAG	1991	S		
M4	9	0	0	0	20	E	RMI	BNA	0	0	0	FRAC	1991	S		
M4	10	0	0	0	20		RMI	BNA	0	0	0	FRAG N.G.	1991	S		
M4	11	0	0	0	19	E	OS	INDET	0	0	0		1991	S		
M4	12	0	0	0	19	E	OS	INDET	0	0	0		1991	S		
M4	13	0	0	0	19	E	OS	DET	0	0	0		1991	S		
M4	14	0	0	0	19	E	OS	INDET	0	0	0		1991	S		
M4	15	0	0	0	19	E	OS	INDET	0	0	0		1991	S		
M4	16	0	0	0	19	E	OS	DET	0	0	0		1991	S		
M4	17	0	0	0	20	E	OS	INDET	0	0	0		1991	S		
M4	18	0	0	0	19	W	RMI	BNA	0	0	0	FRAG	1991	S		
M4	19	0	0	0	19	W	RMI	BNA	0	0	0	FRAG N.G.	1991	S		
M4	20	0	0	0	19	W	RMI	BNA	0	0	0	FRAG	1991	S		
M4	21	0	0	0	19	W	ESQUIST	BNA	0	0	0	FRAG	1991	S		
M4	22	0	0	0	19	W	CONGLOME	BNA	0	0	0	N.G.	1991	S		
M4	23	0	0	0	19	W	ESQUIST	BNA	0	0	0	FRAG	1991	S		
M4	24	0	0	0	19	W	CONGLOME	BNA	0	0	0	N.G.	1991	S		
M4	25	0	0	0	20	W	SORRENCA	BNA	0	0	0	FRAC N.G.	1991	S		
M4	26	0	0	0	20	W	QUARS	BNA	0	0	0	FRAG N.G.	1991	S		
M5	1	0	0	1850	1830		OS	INDET	0	0	0		1991	S		



BOBILA MADURELL  
MAS DURAN  
campanya 1991

E.E. NUM.	X	Y	Zsup	Zinf/ Talla	ORIENT	PENDENT SECTOR	MATERIA	OBJECTE	LONG	AMPL	ESPE	ALTERACIONS	P D	
												OBSERVACIONS	ANY U I N B T U	
M5	2	0	0	0	1840		OS	DET	0	0	0		1991 S	
M5	3	0	0	0	1810		OS	DET	0	0	0		1991 S	
M5	4	0	0	1910	1850		OS	DET	0	0	0	FE?	1991 S	
M5	5	0	0	0	1880		OS	DET	0	0	0	CST CONNEXIO 6	1991 S	
M5	6	0	0	0	1880		OS	DET	0	0	0	CST CONNEXIO 5	1991 S	
M5	7	0	0	0	1920		OS	DET	0	0	0	CST	1991 S	
M5	8	0	0	0	1920		OS	INDET	0	0	0		1991 S	
M5	9	0	0	0	1950		CERAMICA	INFORME	0	0	0	FRAG PROP 8	1991 S	
M5	10	0	0	0	1900	V	CERAMICA	INFORME	0	0	0	FRAG	1991 S	
M5	11	0	0	0	2000		OS	DET	0	0	0		1991 S	
M5	12	0	0	0	1970		OS	INDET	0	0	0		1991 S	
M5	13	0	0	0	1960		OS	INDET	0	0	0		1991 S	
M5	14	0	0	0	1910		OS	DET	0	0	0	FA	1991 S	
M5	15	0	0	2045	1970		RMI	BNA	0	0	0	FRAG N.G.	1991 S	
M5	16	0	0	0	1980		OS	DET	0	0	0	RT	1991 S	
M5	17	0	0	2050	1950		CONGLOME	BNA	0	0	0	FRAG	1991 S	
M5	18	0	0	0	1944		OS	DET	0	0	0	JUNT 17	1991 S	
M5	19	0	0	0	2060		CERAMICA	INFORME	0	0	0	SOTA 17	1991 S	
M5	20	0	0	0	2040	N-S	P	SILEX	BPF	0	0	0		1991 S
M5	21	0	0	2020	2040		V	ORGANIC	MOLUSC	0	0	0	FRAG	1991 S
M5	22	0	0	0	1940		OS	DET	0	0	0	CST?	1991 S	
M5	23	0	0	0	1900		OS	DET	0	0	0		1991 S	
M5	24	0	0	0	1954		OS	DET	0	0	0		1991 S	
M5	25	0	0	0	1945		OS	DET	0	0	0		1991 S	
M5	26	0	0	0	1920		OS	DET	0	0	0	SOTA 23	1991 S	
M5	27	0	0	0	1900		OS	DET	0	0	0	SOTA 25	1991 S	
M5	28	0	0	0	1910		OS	DET	0	0	0		1991 S	
M5	29	0	0	0	2030		OS	DET	0	0	0		1991 S	
M5	30	0	0	0	2050		OS	DET	0	0	0		1991 S	
M5	31	0	0	0	1905		OS	INDET	0	0	0		1991 S	
M5	32	0	0	0	1885		OS	DET	0	0	0	VT?	1991 S	
M5	33	0	0	0	1915		OS	DET	0	0	0		1991 S	
M5	34	0	0	0	1830		OS	DET	0	0	0		1991 S	
M5	35	0	0	0	1865	V	OS	INDET	0	0	0	AMB CONCRECIO	1991 S	
M5	36	0	0	0	0		OS	INDET	0	0	0	SOBRE 5,6	1991 S	
M5	37	0	0	0	2215		OS	INDET	0	0	0		1991 S	
M5	38	0	0	0	2230		OS	DET	0	0	0		1991 S	
M5	39	0	0	2310	2260	N-S	P	RMI	BNA	0	0	0	FRAG SOBRE 40	1991 S
M5	40	0	0	0	2280		OS	DET	0	0	0	REM 44	1991 S	
M5	41	0	0	0	2350		SILEX	BP	0	0	0	LAMINA	1991 S	
M5	42	0	0	0	2385		OS	DET	0	0	0		1991 S	
M5	43	0	0	2320	2350		RMI	BNA	0	0	0	FRAG	1991 S	
M5	44	0	0	2445	2280		OS	DET	0	0	0	REM 40	1991 S	
M5	45	0	0	0	2580		OS	INDET	0	0	0		1991 S	
M5	46	0	0	0	2655		OS	DET	0	0	0	VARIS OSSOS	1991 S	
M5	47	0	0	0	2555		QUARS	BPI	0	0	0		1991 S	
M5	48	0	0	0	2510		QUARS	BP2G	0	0	0		1991 S	
M5	49	0	0	0	2545		CERAMICA	INFORME	0	0	0		1991 S	
M5	50	0	0	0	2570		QUARS	BPI	0	0	0	JUNT 52	1991 S	
M5	51	0	0	0	2610		CALCARIA	BPF	0	0	0		1991 S	
M5	52	0	0	2600	2530		OS	DET	0	0	0		1991 S	

BOBILA MADURELL  
MAS DURAN  
campanya 1991

E.E. NUM.	X	Y	Zsup	Zinf/ Talla	ORIENT SECTOR	PENDENT	MATERIA	OBJECTE	LONG	AMPL	ESPE	ALTERACIONS	P D
												OBSERVACIONS	ANY U I N B T U
M5	53	0	0	0	2506		ORGANIC	MOLUSC	0	0	0	FRAG	1991 S
M5	54	0	0	0	2560		OS	INDET	0	0	0		1991 S
M5	55	0	0	0	2590		OS	DET	0	0	0		1991 S
M5	56	0	0	2715	2595		OS	DET	0	0	0	TI	1991 S
M5	57	0	0	0	2685		OS	DET	0	0	0	CST	1991 S
M5	58	0	0	0	2575		OS	DET	0	0	0	CS	1991 S
M5	59	0	0	0	2515		OS	DET	0	0	0	SOTA 55	1991 S
M5	60	0	0	2780	2588		OS	DET	0	0	0	PR	1991 S
M5	61	0	0	2670	2540		OS	DET	0	0	0	CB	1991 S
M5	62	0	0	0	2615		OS	DET	0	0	0	SOBRE 61	1991 S
M5	63	0	0	0	2750		ORGANIC	MOLUSC	0	0	0		1991 S
M5	64	0	0	0	2735		OS	DET	0	0	0		1991 S
M5	65	0	0	0	2770		OS	DET	0	0	0		1991 S
M5	66	0	0	0	2775		OS	DET	0	0	0		1991 S
M5	67	0	0	0	2800		OS	DET	0	0	0		1991 S
M5	68	0	0	0	2805		OS	DET	0	0	0	VT	1991 S
M5	69	0	0	0	2770		OS	DET	0	0	0		1991 S
M5	70	0	0	27	2785		SILEX	BN2G	0	0	0	TRAPECI	1991 S
M5	71	0	0	0	2740		OS	DET	0	0	0	FRAG CST	1991 S
M5	72	0	0	0	2820		OS	DET	0	0	0	CST	1991 S
M5	73	0	0	0	2840		OS	DET	0	0	0		1991 S
M5	74	0	0	0	2810		OS	DET	0	0	0		1991 S
M5	75	0	0	0	2790		OS	DET	0	0	0		1991 S
M5	76	0	0	0	2790		OS	DET	0	0	0	MT?	1991 S
M5	77	0	0	0	2820		CERAMICA	INFORME	0	0	0		1991 S
M5	78	0	0	0	2820	NE-SW S	INDET	BNE	0	0	0	DESTRAL	1991 S
M5	79	0	0	0	2840		OS	DET	0	0	0	FRAG CST	1991 S
M5	80	0	0	0	2860		OS	DET	0	0	0		1991 S
M5	81	0	0	0	2800		OS	DET	0	0	0		1991 S
M5	82	0	0	0	2820		OS	DET	0	0	0	FRAG CST	1991 S
M5	83	0	0	0	0		SILEX	BN2G	0	0	0	TRAPECI	1991 S
M5	84	0	0	0	2830		OS	DET	0	0	0		1991 S
M5	85	0	0	2850	2780		OS	DET	0	0	0		1991 S
M5	86	0	0	0	2860		SILEX	BN2G	0	0	0	TRAPECI	1991 S
M5	87	0	0	0	2840		OS	DET	0	0	0		1991 S
M5	88	0	0	0	2860		OS	DET	0	0	0		1991 S
M5	89	0	0	0	2890		SILEX	BN2G	0	0	0		1991 S
M5	90	0	0	0	2910		OS	DET	0	0	0		1991 S
M5	91	0	0	0	2900		OS	DET	0	0	0		1991 S
M5	92	0	0	0	2840	NW-SE P	SILEX	BN1G	0	0	0	POTA CABRA	1991 S
M5	93	0	0	0	2840	NW-SE P	SILEX	BN1G	0	0	0	POTA CABRA	1991 S
M5	94	0	0	0	2845		CERAMICA	INFORME	0	0	0		1991 S
M5	95	0	0	0	2810	V	INDET	BNE	0	0	0	DESTRAL	1991 S
M5	96	0	0	2890	2810		CONGLOME	BNA	0	0	0	FRAG N.G.	1991 S
M5	97	0	0	0	2870	P	OS	DET	0	0	0	FE	1991 S
M5	98	0	0	2910	2760	NW-SE P	RMI	BNE	0	0	0	FRAG	1991 S
M5	99	0	0	0	2900		SILEX	BPF	0	0	0		1991 S
M5	100	0	0	0	2880		QUARS	BPF	0	0	0		1991 S
M5	101	0	0	0	2860		OS	DET	0	0	0		1991 S
M5	102	0	0	2890	2670		CALCARIA	BNA	0	0	0		1991 S
M5	103	0	0	0	2700		CERAMICA	INFORME	0	0	0	SOTA 102	1991 S

BOBILA MADURELL  
MAS DURAN  
campanya 1991

E.E. NUM.	X	Y	Zsup	Zinf/ Talla	ORIENT	PENDENT SECTOR	MATERIA	OBJECTE	LONG	AMPL	ESPE	ALTERACIONS	P D
												OBSERVACIONS	
M5	104	0	0	0	2850		OS	INDET	0	0	0	SOTA 102	1991 S
M5	105	0	0	2880	2730		GRANIT	BNA	0	0	0	FRAG	1991 S
M5	106	0	0	0	2830		OS	DET	0	0	0	SOTA 105	1991 S
M5	107	0	0	2900	2745		SORRENCA	BNA	0	0	0		1991 S
M5	108	0	0	0	2915		OS	INDET	0	0	0		1991 S
M5	109	0	0	0	2910		OS	INDET	0	0	0		1991 S
M5	110	0	0	0	2880		OS	DET	0	0	0	CONNEXIO 113	1991 S
M5	113	0	0	0	2880		OS	DET	0	0	0		1991 S
M5	114	0	0	2915	2730	V	OS	DET	0	0	0	TI FRAG	1991 S
M5	116	0	0	0	2915		OS	DET	0	0	0	SOTA 98	1991 S
M5	117	0	0	0	2806		OS	INDET	0	0	0		1991 S
M5	118	0	0	0	2905		OS	DET	0	0	0	PEL FRAG	1991 S
M5	119	0	0	0	2905		OS	DET	0	0	0	PEL FRAG	1991 S
M5	120	0	0	0	2905		OS	DET	0	0	0	PEL FRAG	1991 S
M5	121	0	0	0	2905		OS	DET	0	0	0	PEL FRAG	1991 S
M5	122	0	0	0	2905		OS	DET	0	0	0	PEL FRAG	1991 S
M5	123	0	0	0	2910		OS	INDET	0	0	0		1991 S
M5	124	0	0	0	2920		ORGANIC	MOLUSC	0	0	0		1991 S
M5	125	0	0	0	2880		SILEX	BPF	0	0	0		1991 S
M5	126	0	0	0	2820		QUARS	BP2G	0	0	0		1991 S
M5	127	0	0	0	2870		OS	DET	0	0	0		1991 S
M5	128	0	0	0	2880		SILEX	BN2G	0	0	0		1991 S
M5	129	0	0	0	1990		INDET	BNE	0	0	0	DESTRAL	1991 S
M5	130	0	0	0	1990		INDET	BNE	0	0	0	DESTRAL	1991 S
M5	131	0	0	0	2040		RMI	BNA	0	0	0	FRAG	1991 S
M5	132	0	0	0	20	N	OS	DET	0	0	0		1991 S
M5	133	0	0	0	20	N	OS	INDET	0	0	0		1991 S
M5	134	0	0	0	26		OS	INDET	0	0	0		1991 S
M5	135	0	0	0	26		OS	DET	0	0	0	FRAG DENT	1991 S
M5	136	0	0	0	27		OS	DET	0	0	0	FA	1991 S
M5	137	0	0	0	27		OS	DET	0	0	0		1991 S
M5	138	0	0	0	27	W	OS	DET	0	0	0		1991 S
M5	139	0	0	0	27	W	OS	DET	0	0	0		1991 S
M5	140	0	0	0	28	E	OS	DET	0	0	0	DET?	1991 S
M5	141	0	0	0	28	W	OS	INDET	0	0	0		1991 S
M5	142	0	0	0	0		OS	DET	0	0	0	DET?	1991 S
M5	143	0	0	0	23		SILEX	BPF	0	0	0		1991 S
M5	144	0	0	0	23		QUARS	BPF	0	0	0		1991 S
M5	145	0	0	0	23		SILEX	BPF	0	0	0		1991 S
M5	146	0	0	0	23		QUARS	BPI	0	0	0		1991 S
M5	147	0	0	0	24		QUARS	BPF	0	0	0		1991 S
M5	148	0	0	0	26		QUARS	BPI	0	0	0		1991 S
M5	149	0	0	0	27		SILEX	BPF	0	0	0		1991 S
M5	150	0	0	0	28		SILEX	BN2G	0	0	0		1991 S
M5	151	0	0	0	28		SILEX	BN2G	0	0	0		1991 S
M5	152	0	0	0	28		SILEX	BN2G	0	0	0		1991 S
M5	153	0	0	0	0		QUARS	BPF	0	0	0	NETEJA FOSSA	1991 S
M5	154	0	0	0	17	S	CERAMICA	INFORME	0	0	0		1991 S
M5	155	0	0	0	17	S	CERAMICA	INFORME	0	0	0		1991 S
M5	156	0	0	0	19	S	CERAMICA	INFORME	0	0	0		1991 S
M5	157	0	0	0	19	W	CERAMICA	INFORME	0	0	0		1991 S

BOBILA MADURELL  
MAS DURAN  
campanya 1991

E.E. NUM.	X	Y	Zsup	Zinf/ Talla	ORIENT	PENDENT SECTOR	MATERIA	OBJECTE	LONG	AMPL	ESPE	ALTERACIONS	P D
												OBSERVACIONS	ANY U I N B T U
M5	158	0	0	0	20	W	CERAMICA	INFORME	0	0	0		1991 S
M5	159	0	0	0	20	W	CERAMICA	INFORME	0	0	0		1991 S
M5	160	0	0	0	20	W	CERAMICA	VORA	0	0	0		1991 S
M5	161	0	0	0	20	W	CERAMICA	INFORME	0	0	0		1991 S
M5	162	0	0	0	21	E	CERAMICA	VORA	0	0	0		1991 S
M5	163	0	0	0	21	W	CERAMICA	INFORME	0	0	0		1991 S
M5	164	0	0	0	21	W	CERAMICA	INFORME	0	0	0		1991 S
M5	165	0	0	0	24	E	CERAMICA	INFORME	0	0	0		1991 S
M5	166	0	0	0	24	E	CERAMICA	INFORME	0	0	0		1991 S
M5	167	0	0	0	25	E	CERAMICA	INFORME	0	0	0		1991 S
M5	168	0	0	0	25	E	CERAMICA	INFORME	0	0	0		1991 S
M5	169	0	0	0	25	E	CERAMICA	INFORME	0	0	0		1991 S
M5	170	0	0	0	25		CERAMICA	INFORME	0	0	0		1991 S
M5	171	0	0	0	26	E	CERAMICA	INFORME	0	0	0		1991 S
M5	172	0	0	0	26	E	CERAMICA	INFORME	0	0	0		1991 S
M5	173	0	0	0	26	E	CERAMICA	INFORME	0	0	0		1991 S
M5	174	0	0	0	27	E	CERAMICA	INFORME	0	0	0		1991 S
M5	175	0	0	0	27	W	CERAMICA	INFORME	0	0	0		1991 S
M5	176	0	0	0	27	W	CERAMICA	INFORME	0	0	0		1991 S
M5	177	0	0	0	22	E	CERAMICA	INFORME	0	0	0		1991 S
M5	178	0	0	0	22	E	CERAMICA	INFORME	0	0	0		1991 S
M5	179	0	0	0	22	E	CERAMICA	INFORME	0	0	0		1991 S
M5	180	0	0	0	22	E	CERAMICA	INFORME	0	0	0		1991 S
M5	181	0	0	0	22	E	CERAMICA	INFORME	0	0	0		1991 S
M5	182	0	0	0	22	E	CERAMICA	INFORME	0	0	0		1991 S
M5	183	0	0	0	22	W	CERAMICA	INFORME	0	0	0		1991 S
M5	184	0	0	0	22	W	CERAMICA	INFORME	0	0	0		1991 S
M5	185	0	0	0	22	W	CERAMICA	INFORME	0	0	0		1991 S
M5	186	0	0	0	22	W	CERAMICA	INFORME	0	0	0		1991 S
M5	187	0	0	0	22	W	CERAMICA	APLICA	0	0	0		1991 S
M5	188	0	0	0	22	W	CERAMICA	INFORME	0	0	0		1991 S
M5	189	0	0	0	23		CERAMICA	INFORME	0	0	0		1991 S
M5	190	0	0	0	23		CERAMICA	INFORME	0	0	0		1991 S
M5	191	0	0	0	23		CERAMICA	VORA	0	0	0		1991 S
M5	192	0	0	0	0		SILEX	BP2G	0	0	0		1991 S
M5	193	0	0	0	25	E	SILEX	BPF	0	0	0		1991 S
M5	194	0	0	0	19	W	QUARS	BNA	0	0	0	FRAG	1991 S
M5	195	0	0	0	20	W	QUARS	BNA	0	0	0	FRAG	1991 S
M5	196	0	0	0	22	W	RMI	BNA	0	0	0	FRAG	1991 S
M5	197	0	0	0	25	E	QUARS	BPF	0	0	0		1991 S
M5	198	0	0	0	25	E	QUARS	BPF	0	0	0		1991 S
M5	199	0	0	0	26	E	QUARS	BNA	0	0	0	FRAG	1991 S
M5	200	0	0	0	26	E	QUARS	BNA	0	0	0	VARIS FRAGS	1991 S
M5	201	0	0	0	26	E	QUARS	BPF	0	0	0		1991 S
M5	202	0	0	0	27	W	RMI	BNA	0	0	0		1991 S
M5	203	0	0	0	27	W	QUARS	BNA	0	0	0	FRAG	1991 S
M5	204	0	0	0	28	E	RMI	BNA	0	0	0	FRAG	1991 S
M5	205	0	0	0	28	W	QUARS	BNA	0	0	0	FRAG	1991 S
M5	206	0	0	0	20		RMI	BNA	0	0	0	N.G.	1991 S
M5	207	0	0	0	23	E	INDET	BNA	0	0	0	FRAG	1991 S
M5	208	0	0	0	28		CALAITA	DENA	0	0	0		1991 S

BOBILA MADURELL  
MAS DURAN  
campanya 1991

E.E. NUM.	X	Y	Zsup	Zinf/ Talla	ORIENT	PENDENT SECTOR	MATERIA	OBJECTE	LONG	AMPL	ESPE	ALTERACIONS	P D
												OBSERVACIONS	ANY U I N B T U
M6	1	0	0	0	20	E	CERAMICA	INFORME	0	0	0	VARIS FRAGS	1991 S
M6	2	0	0	0	1950		OS	DET	0	0	0	VARIS OS I DENT	1991 S
M6	3	0	0	0	1870		OS	DET	0	0	0		1991 S
M6	4	0	0	0	1865		OS	INDET	0	0	0		1991 S
M6	5	0	0	0	1865		OS	INDET	0	0	0		1991 S
M6	6	0	0	0	1850		OS	INDET	0	0	0	FRAG	1991 S
M6	7	0	0	0	1880		OS	DET	0	0	0	DENT	1991 S
M6	8	0	0	0	1830		OS	INDET	0	0	0	FRAG	1991 S
M6	9	0	0	0	18	W	CERAMICA	INFORME	0	0	0		1991 S
M6	10	0	0	0	18	W	CERAMICA	INFORME	0	0	0		1991 S
M6	11	0	0	0	19	W	CERAMICA	INFORME	0	0	0		1991 S
M6	12	0	0	0	18		SILEX	BP	0	0	0	2 FRAGS	1991 S
M6	13	0	0	0	18		OS	INDET	0	0	0		1991 S
M6	14	0	0	0	0		CERAMICA	INFORME	0	0	0	VARIS FRAGS	1991 S
M7	1	0	0	0	2810	P	OS	INDET	0	0	0	FRAG CRA	1991 S
M7	2	0	0	0	2840	NW-SE	OS	DET	0	0	0		1991 S
M7	3	0	0	0	2810	E-W	OS	DET	0	0	0	MD Inf + DENT	1991 S
M7	4	0	0	0	2850	N-S	OS	DET	0	0	0	FRAG CST	1991 S
M7	5	0	0	0	2900	NW-SE	OS	DET	0	0	0	FRAG CST	1991 S
M7	6	0	0	0	2870	NW-SE	OS	DET	0	0	0	FRAG CST?	1991 S
M7	7	0	0	0	2880	NW-SE	OS	DET	0	0	0	FRAG CST?	1991 S
M7	8	0	0	0	2880	NE-SW	OS	DET	0	0	0	FRAG CST?	1991 S
M7	9	0	0	0	2890	P	SILEX	BN2G	0	0	0	TRAPECI	1991 S
M7	10	0	0	0	2990		OS	DET	0	0	0	FA	1991 S
M7	11	0	0	0	2890		OS	DET	0	0	0		1991 S
M7	12	0	0	0	2990	NE-SW	OS	DET	0	0	0	FRAG CST?	1991 S
M7	13	0	0	2810	2980	E-W	RMI	BNA	0	0	0	FRAG	1991 S
M7	14	0	0	2850	3000	E-W	RMI	BNA	0	0	0		1991 S
M7	15	0	0	0	2930	NW-SE	OS	DET	0	0	0	E SENCERA	1991 S
M7	16	0	0	0	2930	E-W	RMI	BNA	0	0	0	FRAG	1991 S
M7	17	0	0	0	2910	NW-SE	RMI	BNA	0	0	0	FRAG	1991 S
M7	18	0	0	0	2880	NE-SW	OS	DET	0	0	0	FRAG CST	1991 S
M7	19	0	0	0	2910	N-S	CERAMICA	INFORME	0	0	0		1991 S
M7	20	0	0	0	2865	E-W	OS	DET	0	0	0	CRA INDIVIDU	1991 S
M7	21	0	0	0	2900	E-W	OS	DET	0	0	0		1991 S
M7	22	0	0	2850	2970	E-W	RMI	BNE	0	0	0	FRAG MOLI	1991 S
M7	23	0	0	0	2940	N-S	CERAMICA	INFORME	0	0	0		1991 S
M7	24	0	0	0	2955		OS	DET	0	0	0	VT	1991 S
M7	25	0	0	0	2980		OS	DET	0	0	0	VT	1991 S
M7	26	0	0	0	2970	E-W	OS	BN2G	0	0	0	PUNXO REM 62	1991 S
M7	27	0	0	2890	3050	E-W	SORRENCA	BNA	0	0	0		1991 S
M7	28	0	0	0	3000	N-S	SORRENCA	BNE	0	0	0		1991 S
M7	29	0	0	2830	2960	NE-SW	RMI	BNA	0	0	0		1991 S
M7	30	0	0	0	2980	NW-SE	OS	DET	0	0	0	FRAG CST	1991 S
M7	31	0	0	0	2975		OS	DET	0	0	0	DENT	1991 S
M7	32	0	0	0	2980		OS	DET	0	0	0	DENT	1991 S
M7	33	0	0	0	2990		OS	DET	0	0	0	DENT	1991 S
M7	34	0	0	0	2980		OS	DET	0	0	0	DENT	1991 S
M7	35	0	0	0	2980		OS	DET	0	0	0		1991 S
M7	36	0	0	0	2930		OS	DET	0	0	0	FRAG CST	1991 S
M7	37	0	0	0	2980		OS	DET	0	0	0	FRAG CRA	1991 S

BOBILA MADURELL  
MAS DURAN  
campanya 1991

E.E. NUM.	X	Y	Zsup	Zinf/ Talla	ORIENT	PENDENT SECTOR	MATERIA	OBJECTE	LONG	AMPL	ESPE	ALTERACIONS OBSERVACIONS	P D				
													ANY	U	I	N B T U	
M7	38	0	0	0	2980		OS	DET	0	0	0	OCP + VT	1991	S			
M7	39	0	0	2910	3050	NW-SE SE	RMI	BNE	0	0	0	MA DE MOLI	1991	S			
M7	40	0	0	0	3030		RMI	BNA	0	0	0	FRAG	1991	S			
M7	41	0	0	0	3000		OS	DET	0	0	0	FA 1	1991	S			
M7	42	0	0	0	3010		OS	DET	0	0	0	CB D	1991	S			
M7	43	0	0	0	3000		OS	DET	0	0	0	M 1	1991	S			
M7	44	0	0	0	3000		OS	DET	0	0	0	M	1991	S			
M7	45	0	0	0	3010		OS	BN2G	0	0	0	MPa PUNXO FRAG	1991	S			
M7	46	0	0	0	3030		OS	DET	0	0	0	MT	1991	S			
M7	47	0	0	0	3025	N-S P	SILEX	BPF	0	0	0	FRAG LAMINA	1991	S			
M7	48	0	0	0	2950		OS	DET	0	0	0	DENT	1991	S			
M7	49	0	0	0	3020		OS	DET	0	0	0		1991	S			
M7	50	0	0	0	3020	N-S E	CERAMICA	INFORME	0	0	0		1991	S			
M7	51	0	0	0	3000		OS	DET	0	0	0	VT	1991	S			
M7	52	0	0	0	3010		OS	DET	0	0	0	FRAG MPa	1991	S			
M7	53	0	0	0	3010	E-W E	OS	BN2G	0	0	0	PUNXO	1991	S			
M7	54	0	0	0	3010	E-W W	CERAMICA	INFORME	0	0	0		1991	S			
M7	55	0	0	0	3010	NW-SE P	OS	BN2G	0	0	0	AGULLA?	1991	S			
M7	56	0	0	0	3020		OS	BN2G	0	0	0	MPa	1991	S			
M7	57	0	0	0	3020		OS	BN2G	0	0	0	PUNXO	1991	S			
M7	58	0	0	0	3020		OS	BN2G	0	0	0	PUNXO	1991	S			
M7	59	0	0	0	3020		OS	BN2G	0	0	0	PUNXO	1991	S			
M7	60	0	0	0	3020		OS	BN2G	0	0	0	PUNXO	1991	S			
M7	61	0	0	0	3000		SILEX	BN2G	0	0	0		1991	S			
M7	62	0	0	0	3020		OS	BN2G	0	0	0	MTa REM 26	1991	S			
M7	63	0	0	0	3050		OS	DET	0	0	0	CST	1991	S			
M7	64	0	0	0	3060		OS	DET	0	0	0	DENT	1991	S			
M7	65	0	0	0	3050		OS	DET	0	0	0	VT	1991	S			
M7	66	0	0	0	3060		OS	DET	0	0	0	VT	1991	S			
M7	67	0	0	0	3060	N-S E	RMI	BNA	0	0	0		1991	S			
M7	68	0	0	2980	3100	N-S E	RMI	BNA	0	0	0		1991	S			
M7	69	0	0	0	3040	E	OS	DET	0	0	0	RA E	1991	S			
M7	70	0	0	0	3055		OS	DET	0	0	0	DENT	1991	S			
M7	71	0	0	0	3060		OS	DET	0	0	0	DENT	1991	S			
M7	72	0	0	0	3060	E-W N	CERAMICA	INFORME	0	0	0		1991	S			
M7	73	0	0	0	3070	E-W S	CERAMICA	INFORME	0	0	0		1991	S			
M7	74	0	0	0	3050		OS	DET	0	0	0	FA	1991	S			
M7	75	0	0	0	3045		OS	DET	0	0	0		1991	S			
M7	76	0	0	0	3050		OS	DET	0	0	0	AST	1991	S			
M7	77	0	0	0	3045		OS	DET	0	0	0		1991	S			
M7	78	0	0	0	3040		OS	DET	0	0	0	FRAG CST	1991	S			
M7	79	0	0	0	3035		OS	DET	0	0	0	FRAG RA D	1991	S			
M7	80	0	0	0	3080		QUARS	BNA	0	0	0		1991	S			
M7	81	0	0	0	3045		OS	DET	0	0	0	FA	1991	S			
M7	82	0	0	0	3045		OS	DET	0	0	0	FA	1991	S			
M7	83	0	0	0	3040		OS	DET	0	0	0	FA	1991	S			
M7	84	0	0	0	3050		OS	DET	0	0	0	FRAG CB E	1991	S			
M7	85	0	0	0	3070		OS	DET	0	0	0	PR D	1991	S			
M7	86	0	0	0	2975	V	OS	DET	0	0	0	TI D	1991	S			
M7	87	0	0	0	3050		OS	DET	0	0	0	TI E	1991	S			
M7	88	0	0	0	3060	E-W E	QUARS	BNA	0	0	0		1991	S			

BOBILA MADURELL  
MAS DURAN  
campanya 1991

E.E. NUM.	X	Y	Zsup	Zinf/ Talla	ORIENT	PENDENT SECTOR	MATERIA	OBJECTE	LONG	AMPL	ESPE	ALTERACIONS	P D
												OBSERVACIONS	ANY U I N B T U
M7	89	0	0	0	3060	N-S	N	RMI	BNA	0	0	0 FRAG	1991 S
M7	90	0	0	0	3020			OS	DET	0	0	0 PEL	1991 S
M7	91	0	0	0	3090			OS	DET	0	0	0 CST	1991 S
M7	92	0	0	0	3090			OS	DET	0	0	0 CL	1991 S
M7	94	0	0	0	3090			OS	DET	0	0	0 E	1991 S
M7	95	0	0	0	3090			OS	DET	0	0	0 CL	1991 S
M7	96	0	0	0	3100			OS	DET	0	0	0 TM	1991 S
M7	97	0	0	0	3100			OS	DET	0	0	0 CST	1991 S
M7	98	0	0	0	3100			OS	DET	0	0	0 FA	1991 S
M7	99	0	0	0	3100			OS	DET	0	0	0 FA	1991 S
M7	100	0	0	0	3100			OS	DET	0	0	0	1991 S
M7	101	0	0	0	3080			OS	DET	0	0	0 VT	1991 S
M7	102	0	0	0	3080			OS	DET	0	0	0 CST	1991 S
M7	103	0	0	0	3080			OS	DET	0	0	0 CST	1991 S
M7	104	0	0	0	3100			OS	DET	0	0	0 CST	1991 S
M7	105	0	0	0	3100			OS	DET	0	0	0 CST	1991 S
M7	106	0	0	0	3080			OS	DET	0	0	0 HU E	1991 S
M7	107	0	0	0	3090			OS	DET	0	0	0 CST	1991 S
M7	108	0	0	0	3080			OS	DET	0	0	0 CST	1991 S
M7	109	0	0	0	3090			OS	DET	0	0	0 CST	1991 S
M7	110	0	0	0	3110	E-W	W	RMI	BNA	0	0	0	1991 S
M7	111	0	0	0	3080			OS	DET	0	0	0 FA	1991 S
M7	112	0	0	0	3080			OS	DET	0	0	0 MT 1 D	1991 S
M7	113	0	0	0	3130			OS	DET	0	0	0 FE E	1991 S
M7	114	0	0	0	3080			OS	DET	0	0	0 FA	1991 S
M7	115	0	0	0	3080			OS	DET	0	0	0 PR E	1991 S
M7	116	0	0	0	3080			OS	DET	0	0	0 VT	1991 S
M7	117	0	0	0	3050			OS	DET	0	0	0 FA 1	1991 S
M7	118	0	0	0	3050			OS	DET	0	0	0 FA	1991 S
M7	119	0	0	0	3070			OS	DET	0	0	0 FRAG PEL	1991 S
M7	120	0	0	0	3070			OS	DET	0	0	0 VT	1991 S
M7	121	0	0	0	3073			OS	DET	0	0	0 MT	1991 S
M7	122	0	0	0	3080			OS	DET	0	0	0 MT	1991 S
M7	123	0	0	0	3110			OS	DET	0	0	0 MT	1991 S
M7	124	0	0	0	3052			OS	DET	0	0	0 FA	1991 S
M7	125	0	0	0	3110			OS	DET	0	0	0 CR	1991 S
M7	126	0	0	0	3100			OS	DET	0	0	0 MT	1991 S
M7	127	0	0	0	3110			OS	DET	0	0	0 CR	1991 S
M7	128	0	0	0	3120			RMI	BNA	0	0	0 FRAG	1991 S
M7	129	0	0	0	3100			OS	DET	0	0	0 VT	1991 S
M7	130	0	0	0	3080			OS	DET	0	0	0 FRAG CRA?	1991 S
M7	131	0	0	0	3100			OS	DET	0	0	0 AT	1991 S
M7	132	0	0	0	3125			SILEX	BPF	0	0	0	1991 S
M7	133	0	0	0	3105			OS	DET	0	0	0 MPa BN2G?	1991 S
M7	134	0	0	0	3145			SILEX	BN2G	0	0	0 TRAPECI	1991 S
M7	135	0	0	0	3100			OS	DET	0	0	0 FA	1991 S
M7	136	0	0	0	3130			OS	DET	0	0	0 VT	1991 S
M7	137	0	0	0	3130			OS	DET	0	0	0	1991 S
M7	138	0	0	0	3120			OS	DET	0	0	0 MPa	1991 S
M7	139	0	0	0	3130			OS	DET	0	0	0	1991 S
M7	140	0	0	0	3070			OS	DET	0	0	0	1991 S

BOBILA MADURELL  
MAS DURAN  
campanya 1991

E.E. NUM.	X	Y	Zsup	Zinf/ Talla	ORIENT SECTOR	PENDENT MATERIA	OBJECTE	LONG	AMPL	ESPE	ALTERACIONS	P D
											OBSERVACIONS	ANY U I N B T U
M7	141	0	0	0	3080	OS	DET	0	0	0	FA	1991 S
M7	142	0	0	0	3085	OS	DET	0	0	0		1991 S
M7	143	0	0	0	3130	OS	DET	0	0	0	FA	1991 S
M7	144	0	0	0	3120	OS	DET	0	0	0	VT + CST	1991 S
M7	145	0	0	0	3100	OS	DET	0	0	0	MT	1991 S
M7	146	0	0	0	3120	OS	DET	0	0	0	FRAG FE D	1991 S
M7	147	0	0	0	3105	OS	DET	0	0	0	FRAG PEL	1991 S
M7	148	0	0	0	3105	OS	DET	0	0	0	CST	1991 S
M7	149	0	0	0	3125	OS	DET	0	0	0	CST	1991 S
M7	150	0	0	0	3105	OS	DET	0	0	0	VT	1991 S
M7	151	0	0	0	3120	OS	DET	0	0	0	CST	1991 S
M7	152	0	0	0	3120	OS	DET	0	0	0	CST	1991 S
M7	153	0	0	0	3105	OS	DET	0	0	0	CST	1991 S
M7	154	0	0	0	3160	OS	DET	0	0	0	DENT	1991 S
M7	155	0	0	0	3100	SILEX	BN2G	0	0	0	TRAPECI	1991 S
M7	156	0	0	0	3125	OS	DET	0	0	0		1991 S
M7	157	0	0	0	3125	OS	DET	0	0	0	CAL	1991 S
M7	158	0	0	0	3135	OS	DET	0	0	0		1991 S
M7	159	0	0	0	3130	OS	DET	0	0	0		1991 S
M7	160	0	0	0	3140	OS	DET	0	0	0	FA	1991 S
M7	161	0	0	3045	3140	RMI	BNA	0	0	0		1991 S
M7	162	0	0	0	3135	OS	DET	0	0	0	CST	1991 S
M7	163	0	0	0	3135	OS	DET	0	0	0	FA	1991 S
M7	164	0	0	0	3145	OS	DET	0	0	0	HU	1991 S
M7	165	0	0	0	3140	OS	DET	0	0	0	FA 1	1991 S
M7	166	0	0	0	3120	OS	DET	0	0	0	FA 1	1991 S
M7	167	0	0	0	3120	OS	DET	0	0	0	FA	1991 S
M7	168	0	0	0	3145	OS	DET	0	0	0	FA	1991 S
M7	169	0	0	0	3120	OS	DET	0	0	0	FA	1991 S
M7	170	0	0	0	3100	OS	DET	0	0	0		1991 S
M7	171	0	0	0	3110	OS	DET	0	0	0	MT	1991 S
M7	172	0	0	0	3110	OS	DET	0	0	0	FA	1991 S
M7	173	0	0	0	3145	OS	DET	0	0	0	MT	1991 S
M7	174	0	0	0	3140	OS	DET	0	0	0	FA	1991 S
M7	175	0	0	0	3140	OS	DET	0	0	0	FA Dis	1991 S
M7	176	0	0	0	3145	OS	DET	0	0	0	FA 1	1991 S
M7	177	0	0	0	3140	OS	DET	0	0	0	FA 1	1991 S
M7	178	0	0	0	3140	OS	DET	0	0	0	FRAG FA 1	1991 S
M7	179	0	0	0	3140	OS	DET	0	0	0	MT 1	1991 S
M7	180	0	0	0	3140	OS	DET	0	0	0	MT 2	1991 S
M7	181	0	0	0	3140	OS	DET	0	0	0	MT 3	1991 S
M7	182	0	0	0	3140	OS	DET	0	0	0	AST	1991 S
M7	183	0	0	0	3140	OS	DET	0	0	0	FA	1991 S
M7	184	0	0	0	3140	OS	DET	0	0	0		1991 S
M7	185	0	0	0	3125	RMI	BNA	0	0	0	FRAG	1991 S
M7	186	0	0	0	3140	OS	DET	0	0	0	CAL	1991 S
M7	187	0	0	0	3140	OS	DET	0	0	0	FA	1991 S
M7	188	0	0	0	3140	OS	DET	0	0	0	MT 4	1991 S
M7	189	0	0	0	3140	V	OS	DET	0	0	ESC	1991 S
M7	190	0	0	0	3140	OS	DET	0	0	0	CBD	1991 S
M7	191	0	0	0	3145	OS	DET	0	0	0	CN	1991 S



BOBILA MADURELL  
MAS DURAN  
campanya 1991

E.E. NUM.	X	Y	Zsup	Zinf/ Talla	ORIENT	PENDENT SECTOR	MATERIA	OBJECTE	LONG	AMPL	ESPE	ALTERACIONS	P D	
												OBSERVACIONS	ANY U I N B T U	
M7	192	0	0	0	3145		OS	DET	0	0	0	CN	1991 S	
M7	193	0	0	0	3000		CERAMICA	INFORME	0	0	0		1991 S	
M7	194	0	0	0	2990		OS	DET	0	0	0	FRAG DI	1991 S	
M7	195	0	0	0	3000		RMI	BNA	0	0	0	FRAG	1991 S	
M7	196	0	0	2945	3060	N-S	V	RMI	BNA	0	0	0		1991 S
M7	197	0	0	2950	3100	NW-SE	V	RMI	BNA	0	0	0		1991 S
M7	198	0	0	0	3120	NW-SE	V	RMI	BNA	0	0	0	FRAC	1991 S
M7	199	0	0	0	3090		OS	DET	0	0	0	CST	1991 S	
M7	200	0	0	0	3090		CERAMICA	INFORME	0	0	0		1991 S	
M7	201	0	0	0	3085		OS	DET	0	0	0	CST	1991 S	
M7	202	0	0	0	3080		OS	DET	0	0	0	FA	1991 S	
M7	203	0	0	0	3125		OS	DET	0	0	0	CST	1991 S	
M7	204	0	0	0	3100		OS	DET	0	0	0	CST	1991 S	
M7	205	0	0	0	3100		OS	DET	0	0	0	CST	1991 S	
M7	206	0	0	0	3140	N-S	P	RMI	BNA	0	0	0	FRAG	1991 S
M7	207	0	0	0	1930	E-W	E	SORRENCA	BNA	0	0	0	FRAG N.G.	1991 S
M7	208	0	0	1850	2010	NW-SE	E	CONGLOME	BNA	0	0	0	N.G.	1991 S
M7	209	0	0	1930	2000	NW-SE	E	SORRENCA	BNA	0	0	0	FRAG N.G.	1991 S
M7	210	0	0	1950	2035	NW-SE	E	SORRENCA	BNE	0	0	0	MOLI DE MA?	1991 S
M7	211	0	0	0	1950	NW-SE	E	RMI	BNA	0	0	0	FRAG N.G.	1991 S
M7	212	0	0	1935	2050	NW-SE	E	RMI	BNA	0	0	0	FRAG N.G.	1991 S
M7	213	0	0	1870	1940	N-S	N	SORRENCA	BNA	0	0	0	FRAG N.G.	1991 S
M7	214	0	0	1910	2010	N-S	S	SORRENCA	BNA	0	0	0	FRAG N.G.	1991 S
M7	215	0	0	1865	2020	NW-SE	E	SORRENCA	BNA	0	0	0	N.G.	1991 S
M7	216	0	0	1870	2020	NW-SE	E	SORRENCA	BNA	0	0	0	N.G.	1991 S
M7	217	0	0	1960	2020	NW-SE	E	SORRENCA	BNA	0	0	0	N.G.	1991 S
M7	218	0	0	1975	2020	NW-SE	P	RMI	BNA	0	0	0	FRAG N.G.	1991 S
M7	219	0	0	1865	2000	N-S	V	CALCARIA	BNA	0	0	0	FRAG N.G.	1991 S
M7	220	0	0	1890	2030	NW-SE	NW	CONGLOME	BNA	0	0	0	N.G.	1991 S
M7	221	0	0	1925	2010	NW-SE	P	RMI	BNA	0	0	0	FRAG N.G.	1991 S
M7	222	0	0	1860	1915	NW-SE	S	RMI	BNA	0	0	0	FRAG N.G.	1991 S
M7	223	0	0	1790	1900	E-W	P	RMI	BNA	0	0	0	FRAG N.G.	1991 S
M7	224	0	0	0	1945		V	RMI	BNA	0	0	0	FRAG N.G.	1991 S
M7	225	0	0	0	18		E	CERAMICA	INFORME	0	0	0		1991 S
M7	226	0	0	0	18		E	CERAMICA	INFORME	0	0	0	2 FRAGS	1991 S
M7	227	0	0	0	18		W	CERAMICA	INFORME	0	0	0		1991 S
M7	228	0	0	0	18		W	CERAMICA	INFORME	0	0	0	2 FRAGS	1991 S
M7	229	0	0	0	18		W	CERAMICA	VORA	0	0	0		1991 S
M7	230	0	0	0	18		W	CERAMICA	INFORME	0	0	0		1991 S
M7	231	0	0	0	18		W	CERAMICA	INFORME	0	0	0		1991 S
M7	232	0	0	0	18		W	CERAMICA	INFORME	0	0	0		1991 S
M7	233	0	0	0	18		W	CERAMICA	INFORME	0	0	0		1991 S
M7	234	0	0	0	18		W	CERAMICA	INFORME	0	0	0		1991 S
M7	235	0	0	0	19		E	CERAMICA	INFORME	0	0	0	VARIS FRAGS	1991 S
M7	236	0	0	0	19		E	CERAMICA	INFORME	0	0	0		1991 S
M7	237	0	0	0	19		E	CERAMICA	INFORME	0	0	0		1991 S
M7	238	0	0	0	19		W	CERAMICA	INFORME	0	0	0		1991 S
M7	239	0	0	0	19		W	CERAMICA	INFORME	0	0	0	VARIS FRAGS	1991 S
M7	240	0	0	0	19		W	CERAMICA	INFORME	0	0	0		1991 S
M7	241	0	0	0	19		W	CERAMICA	INFORME	0	0	0		1991 S
M7	242	0	0	0	19		W	CERAMICA	INFORME	0	0	0	2 FRAGS	1991 S

BOBILA MADURELL  
MAS DURAN  
campanya 1991

E.E. NUM.	X	Y	Zsup	Zinf/ Talla	ORIENT	PENDENT SECTOR	MATERIA	OBJECTE	LONG	AMPL	ESPE	ALTERACIONS	P D
												OBSERVACIONS	
M7	243	0	0	0	19	W	CERAMICA	INFORME	0	0	0		1991 S
M7	244	0	0	0	19	W	CERAMICA	INFORME	0	0	0		1991 S
M7	245	0	0	0	19	W	CERAMICA	INFORME	0	0	0	VARIS FRAGS	1991 S
M7	246	0	0	0	20	E	CERAMICA	INFORME	0	0	0		1991 S
M7	247	0	0	0	20	E	CERAMICA	INFORME	0	0	0		1991 S
M7	248	0	0	0	20	E	CERAMICA	INFORME	0	0	0		1991 S
M7	249	0	0	0	20	E	CERAMICA	INFORME	0	0	0		1991 S
M7	250	0	0	0	20	E	CERAMICA	INFORME	0	0	0		1991 S
M7	251	0	0	0	20	E	CERAMICA	INFORME	0	0	0		1991 S
M7	252	0	0	0	20	W	CERAMICA	INFORME	0	0	0		1991 S
M7	253	0	0	0	20	W	CERAMICA	INFORME	0	0	0		1991 S
M7	254	0	0	0	20	W	CERAMICA	INFORME	0	0	0		1991 S
M7	255	0	0	0	20	W	CERAMICA	INFORME	0	0	0		1991 S
M7	256	0	0	0	20	W	CERAMICA	INFORME	0	0	0		1991 S
M7	257	0	0	0	20	W	CERAMICA	INFORME	0	0	0		1991 S
M7	258	0	0	0	20	W	CERAMICA	INFORME	0	0	0		1991 S
M7	259	0	0	0	20	W	CERAMICA	INFORME	0	0	0		1991 S
M7	260	0	0	0	20	W	CERAMICA	INFORME	0	0	0		1991 S
M7	261	0	0	0	20	W	CERAMICA	INFORME	0	0	0		1991 S
M7	262	0	0	0	20	W	CERAMICA	INFORME	0	0	0		1991 S
M7	263	0	0	0	20	W	CERAMICA	INFORME	0	0	0		1991 S
M7	264	0	0	0	20	W	CERAMICA	INFORME	0	0	0		1991 S
M7	265	0	0	0	20	W	CERAMICA	INFORME	0	0	0		1991 S
M7	266	0	0	0	19		CERAMICA	VORA	0	0	0		1991 S
M7	267	0	0	0	19		CERAMICA	INFORME	0	0	0		1991 S
M7	268	0	0	0	21	W	CERAMICA	INFORME	0	0	0		1991 S
M7	269	0	0	0	21	W	CERAMICA	INFORME	0	0	0		1991 S
M7	270	0	0	0	21	W	CERAMICA	INFORME	0	0	0	VARIS FRAGS	1991 S
M7	271	0	0	0	21	W	CERAMICA	INFORME	0	0	0		1991 S
M7	272	0	0	0	22	E	CERAMICA	INFORME	0	0	0		1991 S
M7	273	0	0	0	22	E	CERAMICA	INFORME	0	0	0		1991 S
M7	274	0	0	0	22	E	CERAMICA	INFORME	0	0	0		1991 S
M7	275	0	0	0	22	W	CERAMICA	INFORME	0	0	0		1991 S
M7	276	0	0	0	22	E	CERAMICA	INFORME	0	0	0		1991 S
M7	277	0	0	0	22	E	CERAMICA	INFORME	0	0	0	2 FRAGS	1991 S
M7	278	0	0	0	22	W	CERAMICA	INFORME	0	0	0		1991 S
M7	279	0	0	0	22	W	CERAMICA	INFORME	0	0	0		1991 S
M7	280	0	0	0	22	W	CERAMICA	INFORME	0	0	0		1991 S
M7	281	0	0	0	22	W	CERAMICA	INFORME	0	0	0	VARIS FRAGS	1991 S
M7	282	0	0	0	23	W	CERAMICA	INFORME	0	0	0		1991 S
M7	283	0	0	0	23	W	CERAMICA	INFORME	0	0	0		1991 S
M7	284	0	0	0	23	W	CERAMICA	APLICA	0	0	0	MAMELO	1991 S
M7	285	0	0	0	23	W	CERAMICA	VORA	0	0	0		1991 S
M7	286	0	0	0	23	W	CERAMICA	VORA	0	0	0		1991 S
M7	287	0	0	0	24	E	CERAMICA	PANXA	0	0	0		1991 S
M7	288	0	0	0	24	W	CERAMICA	INFORME	0	0	0		1991 S
M7	289	0	0	0	24	W	CERAMICA	INFORME	0	0	0		1991 S
M7	290	0	0	0	24	W	CERAMICA	INFORME	0	0	0		1991 S
M7	291	0	0	0	24	W	CERAMICA	INFORME	0	0	0		1991 S
M7	292	0	0	0	24	W	CERAMICA	INFORME	0	0	0		1991 S
M7	293	0	0	0	24	W	CERAMICA	INFORME	0	0	0	2 FRAGS	1991 S

BOBILA MADURELL  
MAS DURAN  
campanya 1991

E.E. NUM.	X	Y	Zsup	Zinf/ Talla	ORIENT	PENDENT SECTOR	MATERIA	OBJECTE	LONG	AMPL	ESPE	ALTERACIONS	P D
												OBSERVACIONS	
M7	294	0	0	0	24	W	CERAMICA	INFORME	0	0	0		1991 S
M7	295	0	0	0	24	W	CERAMICA	INFORME	0	0	0		1991 S
M7	296	0	0	0	24	W	CERAMICA	INFORME	0	0	0		1991 S
M7	297	0	0	0	24	W	CERAMICA	INFORME	0	0	0		1991 S
M7	298	0	0	0	24	W	CERAMICA	INFORME	0	0	0		1991 S
M7	299	0	0	0	24	W	CERAMICA	INFORME	0	0	0		1991 S
M7	300	0	0	0	24	W	CERAMICA	INFORME	0	0	0		1991 S
M7	301	0	0	0	24	W	CERAMICA	INFORME	0	0	0		1991 S
M7	302	0	0	0	24	W	CERAMICA	VORA	0	0	0		1991 S
M7	303	0	0	0	24	W	CERAMICA	INFORME	0	0	0		1991 S
M7	304	0	0	0	25	W	CERAMICA	INFORME	0	0	0		1991 S
M7	305	0	0	0	26	E	TOVOT	FRAG	0	0	0		1991 S
M7	306	0	0	0	26	E	CERAMICA	INFORME	0	0	0	2 FRAGS	1991 S
M7	307	0	0	0	26	W	CERAMICA	INFORME	0	0	0		1991 S
M7	308	0	0	0	26	W	CERAMICA	INFORME	0	0	0		1991 S
M7	309	0	0	0	26	W	CERAMICA	INFORME	0	0	0		1991 S
M7	310	0	0	0	26	W	CERAMICA	INFORME	0	0	0		1991 S
M7	311	0	0	0	26	W	CERAMICA	INFORME	0	0	0		1991 S
M7	312	0	0	0	27	W	CERAMICA	INFORME	0	0	0		1991 S
M7	313	0	0	0	27	W	CERAMICA	INFORME	0	0	0	0 VARIS FRAGS	1991 S
M7	314	0	0	0	27	W	CERAMICA	INFORME	0	0	0	0 VARIS FRAGS	1991 S
M7	315	0	0	0	27	W	CERAMICA	INFORME	0	0	0		1991 S
M7	316	0	0	0	27	W	CERAMICA	NANSA	0	0	0	0 FRAG NANSA	1991 S
M7	317	0	0	0	27	W	CERAMICA	INFORME	0	0	0	0 VARIS FRAGS	1991 S
M7	318	0	0	0	27	W	CERAMICA	INFORME	0	0	0	0 2 FRAGS	1991 S
M7	319	0	0	0	27	W	CERAMICA	INFORME	0	0	0		1991 S
M7	320	0	0	0	27	W	CERAMICA	INFORME	0	0	0		1991 S
M7	321	0	0	0	28	W	CERAMICA	INFORME	0	0	0		1991 S
M7	322	0	0	0	28	W	CERAMICA	INFORME	0	0	0		1991 S
M7	323	0	0	0	28	W	CERAMICA	INFORME	0	0	0		1991 S
M7	324	0	0	0	28	W	CERAMICA	INFORME	0	0	0		1991 S
M7	325	0	0	0	28	W	CERAMICA	INFORME	0	0	0		1991 S
M7	326	0	0	0	28	W	CERAMICA	INFORME	0	0	0		1991 S
M7	327	0	0	0	28	W	CERAMICA	INFORME	0	0	0		1991 S
M7	328	0	0	0	28	W	CERAMICA	INFORME	0	0	0		1991 S
M7	329	0	0	0	28	W	CERAMICA	INFORME	0	0	0		1991 S
M7	330	0	0	0	29	W	CERAMICA	INFORME	0	0	0		1991 S
M7	331	0	0	0	30	W	CERAMICA	CARENA	0	0	0		1991 S
M7	332	0	0	0	30	W	CERAMICA	INFORME	0	0	0		1991 S
M7	333	0	0	0	30	W	CERAMICA	INFORME	0	0	0	0 VARIS FRAGS	1991 S
M7	334	0	0	0	18		CONGLOME	BNA	0	0	0	0 FRAG N.G.	1991 S
M7	335	0	0	0	18		RMI	BNA	0	0	0	0 FRAG	1991 S
M7	336	0	0	0	18		RMI	BNA	0	0	0	0 FRAG	1991 S
M7	337	0	0	0	18		CALCARIA	BNA	0	0	0	0 FRAG	1991 S
M7	338	0	0	0	18		RMI	BNA	0	0	0	0 FRAG N.G.	1991 S
M7	339	0	0	0	18		ESQUIST	BNA	0	0	0	0 FRAG	1991 S
M7	340	0	0	0	18		RMI	BNA	0	0	0	0 FRAG	1991 S
M7	341	0	0	0	18		CONGLOME	BNA	0	0	0	0 FRAG N.G.	1991 S
M7	342	0	0	0	18	W	CALCARIA	BNA	0	0	0	0 FRAC	1991 S
M7	343	0	0	0	19	E	RMI	BNA	0	0	0	0 FRAG	1991 S
M7	344	0	0	0	19	E	SORRENCA	BNA	0	0	0		1991 S

BOBILA MADURELL  
MAS DURAN  
campanya 1991

E.E. NUM.	X	Y	Zsup	Zinf/	ORIENT	PENDENT	MATERIA	OBJECTE	LONG	AMPL	ESPE	ALTERACIONS	P D
												OBSERVACIONS	ANY U I
					Talla	SECTOR						N B	T U
M7	345	0	0	0	19	W	QUARS	BNA	0	0	0	FRAG	1991 S
M7	346	0	0	0	19	W	QUARS	BNA	0	0	0		1991 S
M7	347	0	0	0	19	W	SORRENCA	BNA	0	0	0	FRAG N.G.	1991 S
M7	348	0	0	0	19	W	RMI	BNA	0	0	0	FRAG	1991 S
M7	349	0	0	0	19	W	QUARS	BNA	0	0	0	FRAC	1991 S
M7	350	0	0	0	19	W	RMI	BNA	0	0	0	FRAG	1991 S
M7	351	0	0	0	19	W	RMI	BNA	0	0	0		1991 S
M7	352	0	0	0	20	W	RMI	BNA	0	0	0	FRAG N.G.	1991 S
M7	353	0	0	0	20	W	SORRENCA	BNA	0	0	0	FRAG	1991 S
M7	354	0	0	0	20	W	CONGLOME	BNA	0	0	0	FRAG N.G.	1991 S
M7	355	0	0	0	20	W	CONGLOME	BNE	0	0	0	FRAG MOLI	1991 S
M7	356	0	0	0	20	W	SORRENCA	BNA	0	0	0		1991 S
M7	357	0	0	0	20	W	SORRENCA	BNA	0	0	0	N.G.	1991 S
M7	358	0	0	0	20	W	QUARS	BNA	0	0	0	FRAG	1991 S
M7	359	0	0	0	20	W	SORRENCA	BNA	0	0	0	FRAG N.G.	1991 S
M7	360	0	0	0	20	W	QUARS	BNA	0	0	0	FRAG	1991 S
M7	361	0	0	0	20	W	GRANIT	BNA	0	0	0	FRAG	1991 S
M7	362	0	0	0	21	E	CALCARIA	BNA	0	0	0	FRAG	1991 S
M7	363	0	0	0	21	E	RMI	BNA	0	0	0		1991 S
M7	364	0	0	0	21	W	CALCARIA	BNA	0	0	0	FRAG	1991 S
M7	365	0	0	0	21	W	GRANIT	BNA	0	0	0	FRAG	1991 S
M7	367	0	0	0	22	W	ESQUIST	BNE	0	0	0		1991 S
M7	368	0	0	0	22	W	CONGLOME	BNA	0	0	0	FRAG	1991 S
M7	369	0	0	0	24	W	ESQUIST	BNA	0	0	0	FRAG	1991 S
M7	370	0	0	0	24	W	CALCARIA	BNA	0	0	0	FRAC	1991 S
M7	371	0	0	0	24	W	QUARS	BNA	0	0	0	FRAC	1991 S
M7	372	0	0	0	25	W	QUARS	BNA	0	0	0	N.G.	1991 S
M7	373	0	0	0	27	E	CALCARIA	BNA	0	0	0	FRAC	1991 S
M7	374	0	0	0	28	W	QUARS	BNA	0	0	0	FRAG N.G.	1991 S
M7	375	0	0	0	28	W	SORRENCA	BNE	0	0	0	FRAG MOLI	1991 S
M7	376	0	0	0	18	W	SILEX	BPF	0	0	0		1991 S
M7	377	0	0	0	19	E	SILEX	BN2G	0	0	0		1991 S
M7	378	0	0	0	19	W	QUARS	BP2G	0	0	0		1991 S
M7	379	0	0	0	20	W	SILEX	BP	0	0	0		1991 S
M7	380	0	0	0	20	W	QUARS	BPF	0	0	0		1991 S
M7	381	0	0	0	20	W	QUARS	BP2G	0	0	0		1991 S
M7	382	0	0	0	27	W	QUARS	BP2G	0	0	0		1991 S
M7	383	0	0	0	31		CERAMICA	INFORME	0	0	0		1991 S
M7	384	0	0	0	31		CERAMICA	VORA	0	0	0		1991 S
M7	385	0	0	0	31		CERAMICA	INFORME	0	0	0		1991 S
M7	386	0	0	0	31		CERAMICA	INFORME	0	0	0		1991 S
M7	387	0	0	0	31		CERAMICA	INFORME	0	0	0		1991 S
M7	388	0	0	0	18	W	OS	INDET	0	0	0		1991 S
M7	389	0	0	0	18	W	OS	INDET	0	0	0		1991 S
M7	390	0	0	0	18	W	OS	INDET	0	0	0		1991 S
M7	391	0	0	0	18	W	OS	INDET	0	0	0		1991 S
M7	392	0	0	0	18	W	OS	INDET	0	0	0	CALCINAT	1991 S
M7	393	0	0	0	18	W	OS	INDET	0	0	0	VARIS FRAGS	1991 S
M7	394	0	0	0	18	W	OS	DET	0	0	0		1991 S
M7	395	0	0	0	19	W	OS	INDET	0	0	0		1991 S
M7	396	0	0	0	19	E	OS	INDET	0	0	0	CALCINAT	1991 S

BOBILA MADURELL  
MAS DURAN  
campanya 1991

E.E. NUM.	X	Y	Zsup	Zinf/ Talla	ORIENT	PENDENT SECTOR	MATERIA	OBJECTE	LONG	AMPL	ESPE	ALTERACIONS	P D
												OBSERVACIONS	ANY U I N B T U
M7	397	0	0	0	19	E	OS	INDET	0	0	0		1991 S
M7	398	0	0	0	19	W	OS	INDET	0	0	0		1991 S
M7	399	0	0	0	19	W	OS	INDET	0	0	0		1991 S
M7	400	0	0	0	20	E	OS	DET	0	0	0		1991 S
M7	401	0	0	0	20	E	OS	INDET	0	0	0		1991 S
M7	402	0	0	0	20	E	OS	DET	0	0	0	VT	1991 S
M7	403	0	0	0	20	E	OS	INDET	0	0	0		1991 S
M7	404	0	0	0	20	W	OS	INDET	0	0	0	VARIS FRAGS	1991 S
M7	405	0	0	0	20	W	OS	INDET	0	0	0		1991 S
M7	406	0	0	0	20	W	OS	INDET	0	0	0	CREMAT	1991 S
M7	407	0	0	0	20	W	OS	INDET	0	0	0		1991 S
M7	408	0	0	0	20	W	OS	INDET	0	0	0	2 FRAGS	1991 S
M7	409	0	0	0	20	W	OS	DET	0	0	0	DENT	1991 S
M7	410	0	0	0	21	E	OS	INDET	0	0	0		1991 S
M7	411	0	0	0	21	W	OS	INDET	0	0	0		1991 S
M7	412	0	0	0	21	W	OS	INDET	0	0	0	VARIS FRAGS	1991 S
M7	413	0	0	0	21	W	OS	INDET	0	0	0	CREMAT	1991 S
M7	414	0	0	0	22	E	OS	INDET	0	0	0	VARIS FRAGS	1991 S
M7	415	0	0	0	22	W	OS	DET	0	0	0		1991 S
M7	416	0	0	0	22	W	OS	INDET	0	0	0		1991 S
M7	417	0	0	0	22	W	OS	INDET	0	0	0	2 FRAGS	1991 S
M7	418	0	0	0	23	W	OS	DET	0	0	0		1991 S
M7	419	0	0	0	24	W	OS	INDET	0	0	0		1991 S
M7	420	0	0	0	24	W	OS	DET	0	0	0	DENT	1991 S
M7	421	0	0	0	24	W	OS	INDET	0	0	0		1991 S
M7	422	0	0	0	24	W	OS	INDET	0	0	0		1991 S
M7	423	0	0	0	25	W	OS	DET	0	0	0		1991 S
M7	424	0	0	0	25	W	OS	DET	0	0	0		1991 S
M7	425	0	0	0	24	W	OS	DET	0	0	0	VARIS FRAGS	1991 S
M7	426	0	0	0	26	W	OS	INDET	0	0	0		1991 S
M7	427	0	0	0	26	W	OS	INDET	0	0	0		1991 S
M7	428	0	0	0	26	W	OS	INDET	0	0	0	CREMAT	1991 S
M7	429	0	0	0	26	W	OS	INDET	0	0	0		1991 S
M7	430	0	0	0	26	W	OS	INDET	0	0	0		1991 S
M7	431	0	0	0	27	W	OS	INDET	0	0	0		1991 S
M7	432	0	0	0	27	W	OS	DET	0	0	0		1991 S
M7	433	0	0	0	27	W	OS	DET	0	0	0		1991 S
M7	434	0	0	0	27	W	OS	DET	0	0	0		1991 S
M7	435	0	0	0	27	W	OS	DET	0	0	0	DENT	1991 S
M7	436	0	0	0	27	W	OS	INDET	0	0	0	VARIS FRAGS	1991 S
M7	437	0	0	0	27		OS	DET	0	0	0	FA	1991 S
M7	438	0	0	0	28	W	OS	INDET	0	0	0	VARIS FRAGS	1991 S
M7	439	0	0	0	28	W	OS	DET	0	0	0		1991 S
M7	440	0	0	0	28	W	OS	DET	0	0	0		1991 S
M7	441	0	0	0	28	W	OS	DET	0	0	0		1991 S
M7	442	0	0	0	28	W	OS	DET	0	0	0		1991 S
M7	443	0	0	0	28	W	OS	DET	0	0	0	FA	1991 S
M7	444	0	0	0	28	W	OS	DET	0	0	0	CREMAT	1991 S
M7	445	0	0	0	28	W	OS	DET	0	0	0		1991 S
M7	446	0	0	0	28	W	OS	DET	0	0	0	2 FRAGS	1991 S
M7	447	0	0	0	29	W	OS	INDET	0	0	0		1991 S

BOBILA MADURELL  
MAS DURAN  
campanya 1991

E.E. NUM.	X	Y	Zsup	Zinf/ Talla	ORIENT	PENDENT SECTOR	MATERIA	OBJECTE	LONG	AMPL	ESPE	ALTERACIONS	P D	
												OBSERVACIONS	ANY U I N B T U	
M7	448	0	0	0	29	W	OS	DET	0	0	0	CRA ROSEGADOR	1991 S	
M7	449	0	0	0	30		OS	INDET	0	0	0	CREMAT	1991 S	
M7	450	0	0	0	30		OS	INDET	0	0	0		1991 S	
M7	451	0	0	0	31		OS	INDET	0	0	0		1991 S	
M7	452	0	0	0	0		CALAITA	DENA	0	0	0		1991 S	
M7	453	0	0	0	14	E	QUARS	BPF	0	0	0		1991 S	
M7	454	0	0	0	20	E	CONGLOME	BNE	0	0	0	MOLI DE MA	1991 S	
M8	1	0	0	1600	1680	N-S	E	CALCARIA	BNA	0	0	0	N.G.	1991 S
M8	2	0	0	1700	1860		P	RMI	BNA	0	0	0		1991 S
M8	3	0	0	0	2000		S	CERAMICA	VAS	0	0	0		1991 S
M8	4	0	0	0	2000	N-S	P	SILEX	BPF	0	0	0	FRAG LAMINA	1991 S
M8	5	0	0	0	2005	NW-SE	SE	OS	DET	0	0	0	FR + MX Inf	1991 S
M8	6	0	0	0	2030	NE-SW	SW	OS	DET	0	0	0	MX Inf	1991 S
M8	7	0	0	0	2025		V	OS	DET	0	0	0	BA?	1991 S
M8	8	0	0	1960	2060		P	RMI	BNA	0	0	0		1991 S
M8	9	0	0	0	2020	N-S	S	OS	DET	0	0	0	TI D Lat Ext	1991 S
M8	10	0	0	0	2020	N-S	S	OS	DET	0	0	0	FE D	1991 S
M8	11	0	0	0	2025	N-S	S	OS	DET	0	0	0	TI	1991 S
M8	12	0	0	0	2050	E-W	P	OS	DET	0	0	0	FE	1991 S
M8	13	0	0	0	2065	E-W	P	OS	DET	0	0	0	PR	1991 S
M8	14	0	0	0	2045	E-W	S	CALCARIA	BNA	0	0	0		1991 S
M8	15	0	0	0	2040	E-W	S	CERAMICA	INFORME	0	0	0		1991 S
M8	16	0	0	0	2040			OS	DET	0	0	0		1991 S
M8	17	0	0	0	2070		S	RMI	BNA	0	0	0		1991 S
M8	18	0	0	2635	2705	N-S	P	CALCARIA	BNA	0	0	0		1991 S
M8	19	0	0	0	2695	NE-SW	P	OS	DET	0	0	0	FA BOVID?	1991 S
M8	20	0	0	2678	2710	NE-SW	P	RMI	BNA	0	0	0	FRAG	1991 S
M8	21	0	0	0	2723		P	OS	DET	0	0	0	EI	1991 S
M8	22	0	0	2560	2598		P	RMI	BNA	0	0	0	FRAG	1991 S
M8	23	0	0	2592	2785	NW-SE	NW	RMI	BNA	0	0	0		1991 S
M8	24	0	0	0	2630		N	OS	DET	0	0	0	VARIS FRAGS	1991 S
M8	25	0	0	0	2720			OS	DET	0	0	0		1991 S
M8	26	0	0	0	2702	NW-SE	NW	OS	DET	0	0	0	DENT (BOVID?)	1991 S
M8	27	0	0	2545	2630	NE-SW	SW	CALCARIA	BNA	0	0	0	N.G.	1991 S
M8	28	0	0	0	2810	N-S	S	OS	DET	0	0	0		1991 S
M8	29	0	0	0	2810		S	OS	DET	0	0	0	FRAG CRA	1991 S
M8	30	0	0	2760	2805	N-S	P	CALCARIA	BNA	0	0	0		1991 S
M8	31	0	0	0	2800		S	SILEX	BPF	0	0	0		1991 S
M8	32	0	0	2740	2780	NE-SW	NW	RMI	BNA	0	0	0		1991 S
M8	33	0	0	0	2800	NE-SW	V	OS	DET	0	0	0	CX?	1991 S
M8	34	0	0	0	2790	NE-SW	P	OS	DET	0	0	0	DI OS LLARG	1991 S
M8	35	0	0	0	2800		S	OS	DET	0	0	0		1991 S
M8	36	0	0	0	2805	NE-SW	SW	OS	DET	0	0	0	AST? CAL?	1991 S
M8	37	0	0	0	2800		V	OS	DET	0	0	0		1991 S
M8	38	0	0	0	16	E		CERAMICA	INFORME	0	0	0		1991 S
M8	39	0	0	0	16	E		CERAMICA	INFORME	0	0	0		1991 S
M8	40	0	0	0	16	W		CERAMICA	INFORME	0	0	0		1991 S
M8	41	0	0	0	17	E		CERAMICA	INFORME	0	0	0		1991 S
M8	42	0	0	0	17	E		CERAMICA	INFORME	0	0	0		1991 S
M8	43	0	0	0	17	E		CERAMICA	INFORME	0	0	0		1991 S
M8	44	0	0	0	17	E		CERAMICA	INFORME	0	0	0		1991 S

BOBILA MADURELL  
MAS DURAN  
campanya 1991

E.E. NUM.	X	Y	Zsup	Zinf/ Talla	ORIENT	PENDENT SECTOR	MATERIA	OBJECTE	LONG	AMPL	ESPE	ALTERACIONS	P D
												OBSERVACIONS	ANY U I N B T U
M8	45	0	0	0	17	E	CERAMICA	INFORME	0	0	0		1991 S
M8	46	0	0	0	17	E	CERAMICA	INFORME	0	0	0		1991 S
M8	47	0	0	0	17	W	CERAMICA	INFORME	0	0	0		1991 S
M8	48	0	0	0	17	W	CERAMICA	INFORME	0	0	0		1991 S
M8	49	0	0	0	17	W	CERAMICA	INFORME	0	0	0		1991 S
M8	50	0	0	0	17	W	CERAMICA	INFORME	0	0	0		1991 S
M8	51	0	0	0	17	W	CERAMICA	INFORME	0	0	0		1991 S
M8	52	0	0	0	17	W	CERAMICA	INFORME	0	0	0		1991 S
M8	53	0	0	0	17	W	CERAMICA	INFORME	0	0	0		1991 S
M8	54	0	0	0	17	W	CERAMICA	INFORME	0	0	0		1991 S
M8	55	0	0	0	18	E	CERAMICA	INFORME	0	0	0		1991 S
M8	56	0	0	0	18	W	CERAMICA	INFORME	0	0	0		1991 S
M8	57	0	0	0	18	W	CERAMICA	INFORME	0	0	0		1991 S
M8	58	0	0	0	18	W	CERAMICA	INFORME	0	0	0		1991 S
M8	59	0	0	0	18	W	CERAMICA	INFORME	0	0	0		1991 S
M8	60	0	0	0	18	W	CERAMICA	INFORME	0	0	0		1991 S
M8	61	0	0	0	18	W	CERAMICA	INFORME	0	0	0		1991 S
M8	62	0	0	0	18	W	CERAMICA	INFORME	0	0	0		1991 S
M8	63	0	0	0	18	W	CERAMICA	INFORME	0	0	0		1991 S
M8	64	0	0	0	18	W	CERAMICA	INFORME	0	0	0		1991 S
M8	65	0	0	0	18	W	CERAMICA	INFORME	0	0	0		1991 S
M8	66	0	0	0	19	E	CERAMICA	INFORME	0	0	0		1991 S
M8	67	0	0	0	19	E	CERAMICA	VORA	0	0	0		1991 S
M8	68	0	0	0	19	E	CERAMICA	INFORME	0	0	0		1991 S
M8	69	0	0	0	19	W	CERAMICA	INFORME	0	0	0		1991 S
M8	70	0	0	0	19	W	CERAMICA	INFORME	0	0	0		1991 S
M8	71	0	0	0	19	W	CERAMICA	INFORME	0	0	0		1991 S
M8	72	0	0	0	19	W	CERAMICA	VORA	0	0	0		1991 S
M8	73	0	0	0	19	W	CERAMICA	INFORME	0	0	0		1991 S
M8	74	0	0	0	20	E	CERAMICA	VORA	0	0	0		1991 S
M8	75	0	0	0	20	E	CERAMICA	INFORME	0	0	0		1991 S
M8	76	0	0	0	20		CERAMICA	INFORME	0	0	0		1991 S
M8	77	0	0	0	20		CERAMICA	INFORME	0	0	0		1991 S
M8	78	0	0	0	20		CERAMICA	INFORME	0	0	0		1991 S
M8	79	0	0	0	20		CERAMICA	INFORME	0	0	0	0 VARIS FRAGS	1991 S
M8	80	0	0	0	20		CERAMICA	VORA	0	0	0		1991 S
M8	81	0	0	0	20		CERAMICA	VORA	0	0	0		1991 S
M8	82	0	0	0	20		CERAMICA	INFORME	0	0	0		1991 S
M8	83	0	0	0	20		CERAMICA	VORA	0	0	0		1991 S
M8	84	0	0	0	20		CERAMICA	INFORME	0	0	0		1991 S
M8	86	0	0	0	28		CERAMICA	VORA	0	0	0	0 VARIS FRAGS	1991 S
M8	87	0	0	0	0		CERAMICA	INFORME	0	0	0	0 VARIS FRAGS	1991 S
M8	88	0	0	0	18	E	SILEX	BPF	0	0	0		1991 S
M8	89	0	0	0	18	W	QUARS	BPF	0	0	0		1991 S
M8	90	0	0	0	18	W	QUARS	BPI	0	0	0		1991 S
M8	91	0	0	0	23		SILEX	BPF	0	0	0		1991 S
M8	92	0	0	0	23		SILEX	BN2G	0	0	0	0 LAMINA	1991 S
M8	93	0	0	0	24		QUARS	BP	0	0	0		1991 S
M8	94	0	0	0	25		SILEX	BPI	0	0	0		1991 S
M8	95	0	0	0	21		CERAMICA	INFORME	0	0	0		1991 S
M8	96	0	0	0	21		CERAMICA	INFORME	0	0	0		1991 S

BOBILA MADURELL  
MAS DURAN  
campanya 1991

E.E. NUM.	X	Y	Zsup	Zinf/ Talla	ORIENT SECTOR	PENDENT	MATERIA	OBJECTE	LONG	AMPL	ESPE	ALTERACIONS	P D
												OBSERVACIONS	ANY U I N B T U
M8	97	0	0	0	23		CERAMICA	INFORME	0	0	0		1991 S
M8	98	0	0	0	23		CERAMICA	INFORME	0	0	0		1991 S
M8	99	0	0	0	23		CERAMICA	INFORME	0	0	0		1991 S
M8	100	0	0	0	23		CERAMICA	INFORME	0	0	0		1991 S
M8	101	0	0	0	23		CERAMICA	INFORME	0	0	0		1991 S
M8	102	0	0	0	23		CERAMICA	INFORME	0	0	0		1991 S
M8	103	0	0	0	23		CERAMICA	INFORME	0	0	0		1991 S
M8	104	0	0	0	23		CERAMICA	INFORME	0	0	0		1991 S
M8	105	0	0	0	23		CERAMICA	INFORME	0	0	0		1991 S
M8	106	0	0	0	23		CERAMICA	INFORME	0	0	0		1991 S
M8	107	0	0	0	23		CERAMICA	INFORME	0	0	0		1991 S
M8	108	0	0	0	24		CERAMICA	VORA	0	0	0		1991 S
M8	109	0	0	0	24		CERAMICA	VORA	0	0	0		1991 S
M8	110	0	0	0	24		CERAMICA	VORA	0	0	0		1991 S
M8	111	0	0	0	24		CERAMICA	INFORME	0	0	0		1991 S
M8	112	0	0	0	24		CERAMICA	INFORME	0	0	0		1991 S
M8	113	0	0	0	24		CERAMICA	INFORME	0	0	0		1991 S
M8	114	0	0	0	24		CERAMICA	INFORME	0	0	0		1991 S
M8	115	0	0	0	24		CERAMICA	INFORME	0	0	0		1991 S
M8	116	0	0	0	24		CERAMICA	INFORME	0	0	0		1991 S
M8	117	0	0	0	24		CERAMICA	INFORME	0	0	0		1991 S
M8	118	0	0	0	24		CERAMICA	INFORME	0	0	0		1991 S
M8	119	0	0	0	25		CERAMICA	INFORME	0	0	0		1991 S
M8	120	0	0	0	25		CERAMICA	INFORME	0	0	0		1991 S
M8	121	0	0	0	25		CERAMICA	INFORME	0	0	0		1991 S
M8	122	0	0	0	25		CERAMICA	INFORME	0	0	0		1991 S
M8	123	0	0	0	25		CERAMICA	INFORME	0	0	0		1991 S
M8	124	0	0	0	25		CERAMICA	INFORME	0	0	0		1991 S
M8	125	0	0	0	25		CERAMICA	INFORME	0	0	0		1991 S
M8	126	0	0	0	25		CERAMICA	INFORME	0	0	0		1991 S
M8	127	0	0	0	25		CERAMICA	INFORME	0	0	0		1991 S
M8	128	0	0	0	25		CERAMICA	INFORME	0	0	0		1991 S
M8	129	0	0	0	26		CERAMICA	INFORME	0	0	0		1991 S
M8	130	0	0	0	26		CERAMICA	INFORME	0	0	0		1991 S
M8	131	0	0	0	26		CERAMICA	INFORME	0	0	0		1991 S
M8	132	0	0	0	26		CERAMICA	INFORME	0	0	0		1991 S
M8	133	0	0	0	26		CERAMICA	INFORME	0	0	0		1991 S
M8	134	0	0	0	26		CERAMICA	INFORME	0	0	0		1991 S
M8	135	0	0	0	26		CERAMICA	INFORME	0	0	0		1991 S
M8	137	0	0	0	26		CERAMICA	INFORME	0	0	0		1991 S
M8	138	0	0	0	26		CERAMICA	INFORME	0	0	0		1991 S
M8	139	0	0	0	26		CERAMICA	INFORME	0	0	0		1991 S
M8	140	0	0	0	26		CERAMICA	INFORME	0	0	0		1991 S
M8	141	0	0	0	26		CERAMICA	INFORME	0	0	0		1991 S
M8	142	0	0	0	26		CERAMICA	INFORME	0	0	0		1991 S
M8	143	0	0	0	27		CERAMICA	INFORME	0	0	0		1991 S
M8	144	0	0	0	27		CERAMICA	INFORME	0	0	0		1991 S
M8	145	0	0	0	27		CERAMICA	INFORME	0	0	0		1991 S
M8	146	0	0	0	27		CERAMICA	INFORME	0	0	0		1991 S
M8	147	0	0	0	27		CERAMICA	VORA	0	0	0		1991 S
M8	148	0	0	0	27		CERAMICA	INFORME	0	0	0		1991 S



BOBILA MADURELL  
MAS DURAN  
campanya 1991

E.E. NUM.	X	Y	Zsup	Zinf/ Talla	ORIENT	PENDENT SECTOR	MATERIA	OBJECTE	LONG	AMPL	ESPE	ALTERACIONS	P D
												OBSERVACIONS	ANY U I N B T U
M8	149	0	0	0	27		CERAMICA	INFORME	0	0	0		1991 S
M8	150	0	0	0	27		CERAMICA	INFORME	0	0	0		1991 S
M8	151	0	0	0	27		CERAMICA	INFORME	0	0	0		1991 S
M8	152	0	0	0	27		CERAMICA	INFORME	0	0	0		1991 S
M8	153	0	0	0	27		CERAMICA	VORA	0	0	0	VARIS FRAGS	1991 S
M8	154	0	0	0	27		CERAMICA	INFORME	0	0	0		1991 S
M8	155	0	0	0	27		CERAMICA	INFORME	0	0	0		1991 S
M8	156	0	0	0	27		CERAMICA	INFORME	0	0	0		1991 S
M8	157	0	0	0	27		CERAMICA	INFORME	0	0	0		1991 S
M8	158	0	0	0	27		CERAMICA	INFORME	0	0	0		1991 S
M8	159	0	0	0	27		CERAMICA	INFORME	0	0	0		1991 S
M8	160	0	0	0	27		CERAMICA	INFORME	0	0	0		1991 S
M8	161	0	0	0	27		CERAMICA	INFORME	0	0	0		1991 S
M8	162	0	0	0	28		CERAMICA	INFORME	0	0	0		1991 S
M8	163	0	0	0	28		CERAMICA	INFORME	0	0	0		1991 S
M8	164	0	0	0	28		CERAMICA	INFORME	0	0	0		1991 S
M8	165	0	0	0	28		CERAMICA	INFORME	0	0	0		1991 S
M8	166	0	0	0	28		CERAMICA	INFORME	0	0	0		1991 S
M8	167	0	0	0	28		CERAMICA	INFORME	0	0	0		1991 S
M8	168	0	0	0	28		CERAMICA	INFORME	0	0	0		1991 S
M8	169	0	0	0	28		CERAMICA	VORA	0	0	0		1991 S
M8	170	0	0	0	28		CERAMICA	INFORME	0	0	0		1991 S
M8	171	0	0	0	28		CERAMICA	INFORME	0	0	0		1991 S
M8	172	0	0	0	28		CERAMICA	INFORME	0	0	0		1991 S
M8	173	0	0	0	28		CERAMICA	INFORME	0	0	0		1991 S
M8	174	0	0	0	28		CERAMICA	INFORME	0	0	0		1991 S
M8	175	0	0	0	28		CERAMICA	INFORME	0	0	0		1991 S
M8	176	0	0	0	17	E	RMI	BNA	0	0	0	FRAG N.G.	1991 S
M8	177	0	0	0	18	E	RMI	BNA	0	0	0	FRAG N.G.	1991 S
M8	178	0	0	0	26	E	RMI	BNA	0	0	0	FRAG N.G.	1991 S
M8	179	0	0	0	27		CALCARIA	BNA	0	0	0	N.G.	1991 S
M8	180	0	0	0	18	E	OS	INDET	0	0	0		1991 S
M8	181	0	0	0	18	W	OS	INDET	0	0	0		1991 S
M8	182	0	0	0	19	E	OS	INDET	0	0	0		1991 S
M8	183	0	0	0	19	E	OS	INDET	0	0	0		1991 S
M8	184	0	0	0	20	E	OS	INDET	0	0	0		1991 S
M8	185	0	0	0	20	E	OS	INDET	0	0	0		1991 S
M8	186	0	0	0	23		OS	INDET	0	0	0		1991 S
M8	187	0	0	0	23		OS	DET	0	0	0		1991 S
M8	188	0	0	0	23		OS	INDET	0	0	0		1991 S
M8	189	0	0	0	25		OS	INDET	0	0	0		1991 S
M8	190	0	0	0	26		OS	INDET	0	0	0		1991 S
M8	191	0	0	0	26		OS	INDET	0	0	0		1991 S
M8	192	0	0	0	26		OS	INDET	0	0	0		1991 S
M8	193	0	0	0	27		OS	INDET	0	0	0		1991 S
M8	194	0	0	0	27		OS	INDET	0	0	0		1991 S
M8	195	0	0	0	27		OS	DET	0	0	0		1991 S
M8	196	0	0	0	27		OS	DET	0	0	0	DENT	1991 S
M8	197	0	0	0	27		OS	INDET	0	0	0		1991 S
M8	198	0	0	0	27		OS	DET	0	0	0		1991 S
M8	199	0	0	0	27		OS	INDET	0	0	0		1991 S

BOBILA MADURELL  
MAS DURAN  
campanya 1991

E.E. NUM.	X	Y	Zsup	Zinf/	ORIENT	PENDENT	MATERIA	OBJECTE	LONG	AMPL	ESPE	ALTERACIONS	P D	
												OBSERVACIONS	ANY U I	
				Talla	SECTOR							N B	T U	
M8	200	0	0	0	27		OS	INDET	0	0	0		1991 S	
M8	201	0	0	0	27		OS	INDET	0	0	0		1991 S	
M8	202	0	0	0	28		OS	INDET	0	0	0	VARIS FRAGS	1991 S	
M8	203	0	0	0	28		OS	DET	0	0	0		1991 S	
M8	204	0	0	0	28		OS	DET	0	0	0	FA	1991 S	
M8	205	0	0	0	28		OS	DET	0	0	0	FRAG E	1991 S	
M8	206	0	0	0	28		OS	DET	0	0	0	FA	1991 S	
M8	207	0	0	0	28		OS	DET	0	0	0	FRAG VT	1991 S	
M8	208	0	0	0	28		OS	DET	0	0	0	FRAG CST	1991 S	
M8	209	0	0	0	28		OS	INDET	0	0	0	VARIS FRAGS	1991 S	
M8	210	0	0	0	0		OS	INDET	0	0	0	VARIS FRAGS	1991 S	
M8	212	0	0	0	25		ORGANIC	MOLUSC	0	0	0	FRAG	1991 S	
M9	1	0	0	0	2350	E-W	P	OS	DET	0	0	0		1991 S
M9	2	0	0	0	2203	N-S	P	OS	DET	0	0	0		1991 S
M9	3	0	0	0	2320	N-S	P	SILEX	BP	0	0	0	LAMINA	1991 S
M9	4	0	0	0	2310		P	CALAITA	DENA	0	0	0		1991 S
M9	5	0	0	0	2320		P	CALAITA	DENA	0	0	0		1991 S
M9	6	0	0	0	2320		P	CALAITA	DENA	0	0	0		1991 S
M9	7	0	0	0	2330		P	CALAITA	DENA	0	0	0		1991 S
M9	8	0	0	0	2360		P	CALAITA	DENA	0	0	0		1991 S
M9	9	0	0	0	2360		P	CALAITA	DENA	0	0	0		1991 S
M9	10	0	0	0	2335		OS	DET	0	0	0	FE D Lat Int	1991 S	
M9	11	0	0	0	2330		OS	DET	0	0	0	TI D Lat Int	1991 S	
M9	12	0	0	0	2340		OS	DET	0	0	0	FE E Lat Ext	1991 S	
M9	13	0	0	0	2330		OS	DET	0	0	0	TI E Lat Ext	1991 S	
M9	14	0	0	0	2330		OS	DET	0	0	0		1991 S	
M9	15	0	0	0	2335		OS	DET	0	0	0		1991 S	
M9	16	0	0	0	2340		OS	DET	0	0	0		1991 S	
M9	17	0	0	0	2330		OS	DET	0	0	0		1991 S	
M9	18	0	0	0	2330		OS	DET	0	0	0		1991 S	
M9	19	0	0	0	2330		OS	DET	0	0	0		1991 S	
M9	20	0	0	0	2335		OS	DET	0	0	0		1991 S	
M9	21	0	0	0	2350		OS	DET	0	0	0	CL	1991 S	
M9	22	0	0	0	2350		OS	DET	0	0	0		1991 S	
M9	23	0	0	0	2340		OS	DET	0	0	0		1991 S	
M9	24	0	0	0	2350		OS	DET	0	0	0		1991 S	
M9	25	0	0	0	2350		OS	DET	0	0	0		1991 S	
M9	26	0	0	0	2350		OS	DET	0	0	0		1991 S	
M9	27	0	0	0	2340		OS	DET	0	0	0		1991 S	
M9	28	0	0	0	2340		OS	DET	0	0	0		1991 S	
M9	29	0	0	0	2340		OS	DET	0	0	0		1991 S	
M9	30	0	0	0	2340		OS	DET	0	0	0		1991 S	
M9	31	0	0	0	2340		OS	DET	0	0	0		1991 S	
M9	32	0	0	0	2340		SILEX	BPF	0	0	0	LAMINA	1991 S	
M9	33	0	0	0	2340		CALCARIA	BNA	0	0	0		1991 S	
M9	34	0	0	0	2340		OS	DET	0	0	0		1991 S	
M9	35	0	0	0	2340		OS	DET	0	0	0		1991 S	
M9	36	0	0	0	2340		CERAMICA	INFORME	0	0	0		1991 S	
M9	37	0	0	0	2375		OS	DET	0	0	0	CRA	1991 S	
M9	38	0	0	0	2340		OS	DET	0	0	0		1991 S	
M9	39	0	0	0	2330		OS	DET	0	0	0		1991 S	

BOBILA MADURELL  
MAS DURAN  
campanya 1991

E.E. NUM.	X	Y	Zsup	Zinf/ Talla	ORIENT	PENDENT SECTOR	MATERIA	OBJECTE	LONG	AMPL	ESPE	ALTERACIONS	P D
												OBSERVACIONS	ANY U I N B T U
M9	40	0	0	0	2330	OS	DET		0	0	0		1991 S
M9	41	0	0	0	2330	OS	DET		0	0	0		1991 S
M9	42	0	0	0	2330	OS	DET		0	0	0		1991 S
M9	43	0	0	0	2340	OS	DET		0	0	0		1991 S
M9	44	0	0	0	2340	OS	DET		0	0	0		1991 S
M9	45	0	0	0	2340	OS	DET		0	0	0		1991 S
M9	46	0	0	0	2330	OS	DET		0	0	0		1991 S
M9	47	0	0	0	2340	OS	DET		0	0	0		1991 S
M9	48	0	0	0	2350	OS	DET		0	0	0		1991 S
M9	49	0	0	0	2340	CERAMICA	INFORME		0	0	0		1991 S
M9	51	0	0	0	2340	OS	DET		0	0	0		1991 S
M9	52	0	0	0	2340	OS	DET		0	0	0		1991 S
M9	53	0	0	0	2340	SILEX	BP2G		0	0	0		1991 S
M9	54	0	0	0	2340	SILEX	BP		0	0	0	LAMINA	1991 S
M9	55	0	0	0	2340	OS	DET		0	0	0	DENT	1991 S
M9	56	0	0	0	2350	OS	DET		0	0	0	FRAG CST	1991 S
M9	57	0	0	0	2340	OS	DET		0	0	0	FRAG CST	1991 S
M9	58	0	0	0	2340	OS	DET		0	0	0	FRAG CST	1991 S
M9	59	0	0	0	2340	OS	DET		0	0	0	FRAG CST	1991 S
M9	60	0	0	0	2340	OS	DET		0	0	0		1991 S
M9	61	0	0	0	2340	OS	DET		0	0	0		1991 S
M9	62	0	0	0	2340	OS	DET		0	0	0		1991 S
M9	63	0	0	0	2340	OS	DET		0	0	0		1991 S
M9	64	0	0	0	2340	OS	DET		0	0	0		1991 S
M9	65	0	0	0	2340	OS	DET		0	0	0		1991 S
M9	66	0	0	0	2340	OS	DET		0	0	0		1991 S
M9	67	0	0	0	2340	RMI	BNA		0	0	0		1991 S
M9	68	0	0	0	2340	CALAITA	DENA		0	0	0		1991 S
M9	69	0	0	0	2340	OS	DET		0	0	0		1991 S
M9	70	0	0	0	2340	CALAITA	DENA		0	0	0		1991 S
M9	71	0	0	0	2340	OS	DET		0	0	0		1991 S
M9	72	0	0	0	2340	OS	DET		0	0	0		1991 S
M9	73	0	0	0	2330	OS	DET		0	0	0		1991 S
M9	74	0	0	0	2340	OS	DET		0	0	0		1991 S
M9	75	0	0	0	2350	OS	DET		0	0	0		1991 S
M9	76	0	0	0	2350	OS	DET		0	0	0		1991 S
M9	77	0	0	0	2350	OS	DET		0	0	0	DENT	1991 S
M9	78	0	0	0	2350	OS	DET		0	0	0	DENT	1991 S
M9	79	0	0	0	2350	OS	DET		0	0	0	DENT	1991 S
M9	80	0	0	0	2350	OS	DET		0	0	0		1991 S
M9	81	0	0	0	2350	OS	DET		0	0	0		1991 S
M9	82	0	0	0	2350	OS	DET		0	0	0		1991 S
M9	83	0	0	0	2350	CALAITA	DENA		0	0	0		1991 S
M9	84	0	0	0	2350	CALAITA	DENA		0	0	0		1991 S
M9	85	0	0	0	2350	CALAITA	DENA		0	0	0		1991 S
M9	86	0	0	0	2350	CALAITA	DENA		0	0	0		1991 S
M9	87	0	0	0	2350	OS	DET		0	0	0		1991 S
M9	88	0	0	0	2350	CALAITA	DENA		0	0	0		1991 S
M9	89	0	0	0	2350	CALAITA	DENA		0	0	0		1991 S
M9	90	0	0	0	2350	OS	DET		0	0	0		1991 S
M9	91	0	0	0	2350	OS	DET		0	0	0		1991 S

BOBILA MADURELL  
MAS DURAN  
campanya 1991

E.E. NUM.	X	Y	Zsup	Zinf/ Talla	ORIENT	PENDENT SECTOR	MATERIA	OBJECTE	LONG	AMPL	ESPE	ALTERACIONS	P D
												OBSERVACIONS	ANY U I N B T U
M9	92	0	0	0	2350		OS	DET	0	0	0	DENT	1991 S
M9	93	0	0	0	2350		OS	DET	0	0	0		1991 S
M9	94	0	0	0	2350		CALAITA	DENA	0	0	0		1991 S
M9	95	0	0	0	2350		CALAITA	DENA	0	0	0		1991 S
M9	96	0	0	0	2350		CALAITA	DENA	0	0	0		1991 S
M9	97	0	0	0	2340		CALAITA	DENA	0	0	0		1991 S
M9	98	0	0	0	2350		CALAITA	DENA	0	0	0		1991 S
M9	99	0	0	0	2390		CERAMICA	VAS	0	0	0	FONS CARENA VOR	1991 S
M9	100	0	0	0	2340		SILEX	BN1G	0	0	0	POTA DE CABRA	1991 S
M9	101	0	0	0	2320		RMI	BNA	0	0	0		1991 S
M9	102	0	0	0	2360		CALAITA	DENA	0	0	0		1991 S
M9	103	0	0	0	2350		SILEX	BN2G	0	0	0	LAMINA	1991 S
M9	104	0	0	0	22		CERAMICA	INFORME	0	0	0		1991 S
M9	105	0	0	0	23	E	CERAMICA	INFORME	0	0	0		1991 S
M9	106	0	0	0	23	E	CERAMICA	INFORME	0	0	0		1991 S
M9	107	0	0	0	23	W	CERAMICA	INFORME	0	0	0		1991 S
M9	108	0	0	0	23	W	CERAMICA	INFORME	0	0	0		1991 S
M9	109	0	0	0	23	W	CERAMICA	INFORME	0	0	0		1991 S
M9	110	0	0	0	23	W	CERAMICA	INFORME	0	0	0		1991 S
M9	111	0	0	0	23	W	CERAMICA	INFORME	0	0	0		1991 S
M9	112	0	0	0	23	W	CERAMICA	INFORME	0	0	0		1991 S
M9	113	0	0	0	23	W	CERAMICA	INFORME	0	0	0	VARIS FRAGS	1991 S
M9	114	0	0	0	23	W	QUARS	BPF	0	0	0		1991 S
M9	115	0	0	0	23	W	SILEX	BPF	0	0	0		1991 S
M9	116	0	0	0	22		OS	INDET	0	0	0		1991 S
M9	117	0	0	0	23	E	OS	DET	0	0	0		1991 S
M9	118	0	0	0	23	E	OS	INDET	0	0	0		1991 S
M9	119	0	0	0	23	E	OS	DET	0	0	0		1991 S